

bookboon.com

Theory of waves in materials

Jeremiah Rushchitsky



Download free books at

bookboon.com

Jeremiah Rushchitsky

Theory of waves in materials

Theory of waves in materials

© 2011 Jeremiah Rushchitsky & Ventus Publishing ApS

ISBN 978-87-7681-817-3

Contents

	Foreword	8
	On the auditory. Goals of chapters-lectures presented. Three basic parts of the book. Structure of the single chapter-lecture. On comments. On bibliography. On questions. Waves in the world around. Materials in the world around.	
1	On materials. Preliminary	16
	Continualization and homogenization procedures. Material continuum. Body. Structural mechanics of materials. Macromechanics, mesomechanics, micromechanics, nanomechanics. Composite materials.	
2	On materials. Basic mechanical properties	26
	Basic mechanical properties of materials: elasticity, plasticity, elastoplasticity, rigidplasticity, thermoelasticity, thermoplasticity, viscosity, viscoelasticity, viscoplasticity, diffusional elasticity, electroelasticity, magnetoelasticity. Thermodynamical theory of material continua. On the basic mathematical models	
3	On waves. Basic wave phenomena	38
	Wave equation. Sound waves. Kirchhoff, Poisson, D'Alembert formulas. Well-posedness by Hadamard. Helmholtz and Taylor instabilities. John statement. Basic characteristics of waves. Polarization of waves. Reflection and refraction of waves. Interference of waves. Diffraction of waves.	
4	On waves. Harmonic waves	50
	Basic characteristics of waves. Running waves. Harmonic waves. Wave dispersion. Phase and group wave velocities. Energy of waves. Wave energy velocity. Plane waves.	

Please click the advert

I joined MITAS because
I wanted **real responsibility**

The Graduate Programme
for Engineers and Geoscientists
Maersk.com/Mitas



Month 16

I was a construction supervisor in the North Sea advising and helping foremen solve problems

Real work
International opportunities
Three work placements





Download free ebooks at bookboon.com

5	Elastic volume and shear waves Basic linear elastic model. Kinematics and kinetics of motion. Displacement, strain, stress. Balance equations. Elastic wave equations. Volume and shear elastic waves.	60
6	Elastic linear harmonic plane waves Basic linear model. Plane linear harmonic elastic waves. Christoffel equations. Christoffel tensor. Types of plane waves and corresponding wave equations. Refraction and reflection of plane harmonic elastic waves. Five conditions of the contact	71
7	Rayleigh, Love, Lamb elastic waves Rayleigh waves in the elastic half-space. Love waves in the elastic system 'layer – half-space'. Lamb waves in the elastic layer.	85
8	Elastic waves. Structural linear models Structural linear models. Short review of models. Structural model of mixtures of elastic materials. Shear and inertial mechanisms. Elastic constants	97
9	Elastic harmonic plane waves in mixtures Structural model of mixtures of elastic materials. Elastic wave equations. Plane linear elastic harmonic waves. Examples	110
10	Viscoelastic waves. Basic models Basic models. Boltzmann principle. The simplest rheological models: Maxwell model, Voigt model, Poynting-Thomson and Kelvin models. Relaxation time and retardation time.	123

Please click the advert

www.job.oticon.dk

oticon
PEOPLE FIRST

11	Viscoelastic volume and shear waves Basic viscoelastic models. Rheological equations. Relaxation and creep kernels. Duffing and Boltzmann kernels. Fractional-exponential operators. General statement of the theory of viscoelasticity. Volume and shear waves.	136
12	Viscoelastic plane waves Viscoelastic plane waves. Main features on an example of the plane waves in cases of the classical and structural models.	150
13	Thermoelastic waves. Basic models Basic models. Main thermodynamical potentials. Linear constitutive equations. Full system of equations of the linear theory of thermoelasticity. Coupled and uncoupled system. Spherical harmonic and inharmonic waves within the uncoupled approach	161
14	Thermoelastic plane and spherical waves Coupled system of thermoelasticity. New thermophysical constants. Main features on an example of the plane and spherical waves.	173
15	Elastoplastic waves. Classical models Classical models of elastoplastic deformation. Conditions of plasticity, Tresca and Huber- Mises criteria. Simple and complex loading, unloading. Basic system of equations.	183
16	Elastoplastic shock waves Classical models of elastoplastic deformation. Shock waves in the rod. Basic system of equations. Basic properties of shock waves.	195

Please click the advert

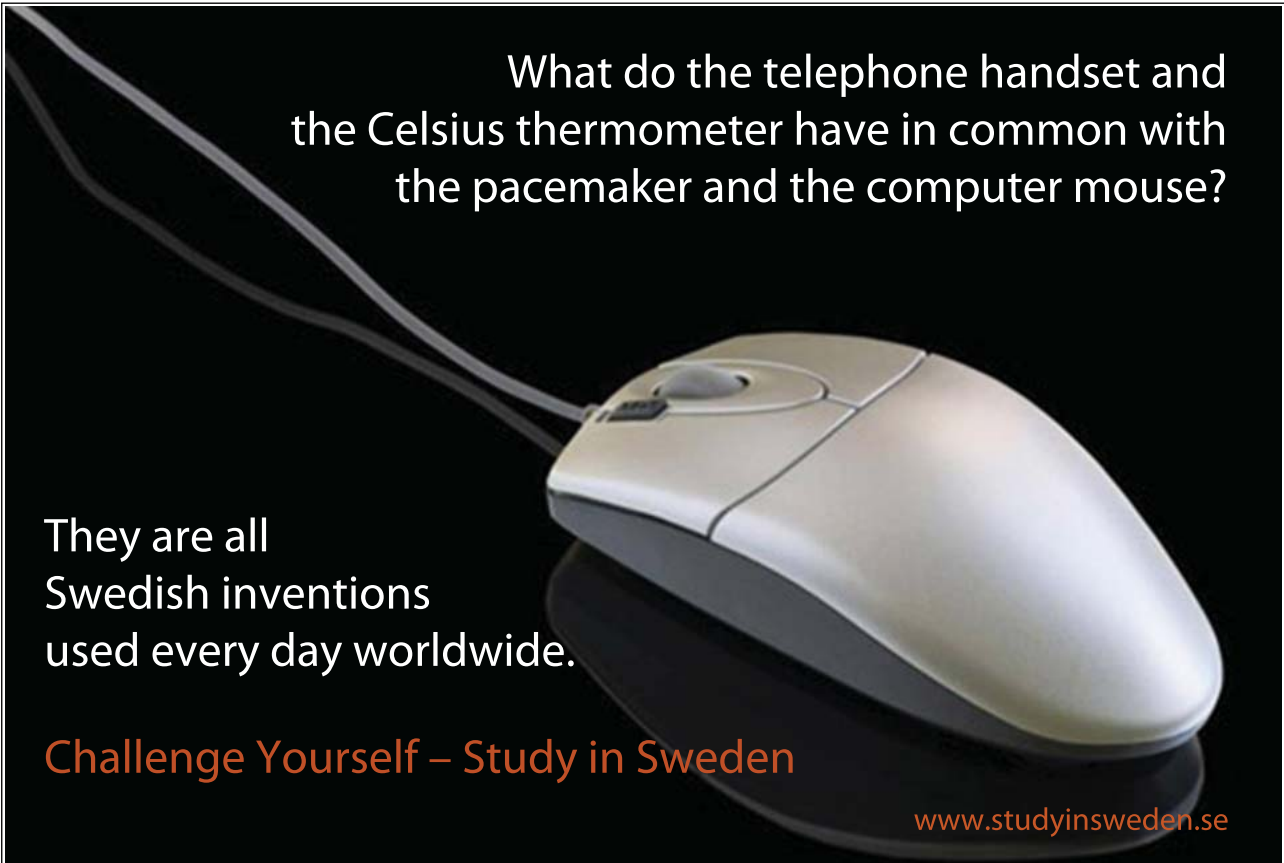

What do the telephone handset and the Celsius thermometer have in common with the pacemaker and the computer mouse?

They are all Swedish inventions used every day worldwide.

Challenge Yourself – Study in Sweden

www.studyinsweden.se

17	Piezoelastic waves. Classical models	207
	Dielectrics. Piezoelectric materials. Polarization. The direct and inverse piezoelectric effects. Basic classical model. Coupled systems of equations. New physical constants.	
18	Piezoelastic plane waves	220
	Basic classical model. Wave equations for new kinds of materials with new levels of physical properties symmetry. Plane waves. Christoffel tensor and Christoffel equations. Quasi-longitudinal and quasi-transverse plane waves. Piezo-electrically active waves. Coefficient of electromechanical coupling. Main features of plane waves within the framework of the basic model.	
19	Piezoelastic waves in piezopowders	232
	Piezocrystals, piezoceramics, piezopowders. Basic structural model of piezoelastic mixtures. Linear wave equations. Plane piezoelastic waves. Main features on an example of the plane waves.	
20	Magnetoelastic waves	246
	Basic model. Cases of real and perfect conductivity. Coupled systems of equations. Main features on an example of the plane magnetoelastic waves	
	Afterword	262
	Final comparative remarks on classical models of materials and corresponding basic properties of waves in materials	

Please click the advert

STUDY FOR YOUR MASTER'S DEGREE
IN THE CRADLE OF SWEDISH ENGINEERING

Chalmers University of Technology conducts research and education in engineering and natural sciences, architecture, technology-related mathematical sciences and nautical sciences. Behind all that Chalmers accomplishes, the aim persists for contributing to a sustainable future – both nationally and globally.

Visit us on Chalmers.se or **Next Stop Chalmers** on facebook.



CHALMERS
UNIVERSITY OF TECHNOLOGY

Download free ebooks at bookboon.com

Foreword

On the auditory. Goals of chapters-lectures presented. Three basic parts of the book. Structure of the single chapter-lecture. On comments. On bibliography. On questions. Waves in the world around. Materials in the world around.

The book is proposed for the auditory moderately educated in the field of mechanics and mathematics. It does not assume that the presence of elementary knowledge only will be sufficient for its understanding. In the field of mechanics, the knowledge of fundamentals of continuum mechanics will be required, which in turn are available on conditions that elements of a row of other divisions of mechanics are known. In the field of mathematics, the elements of knowledge of the full university course (mathematical analysis, analytical and differential geometry, theory of functions of complex variable, vector and tensor calculation, higher algebra) will be required.

The main goal is the coherent treatment of the theory of waves propagating in materials. The unabridged presentation of such a theory is practically impossible because of the huge number of accumulated observations and published theoretical results.

The offered book (the short course of twenty chapters-lectures) is therefore based on the concept of concentration on the correlation among:

- A. **The basic physical properties of materials.**
- B. **The reflecting these properties mathematical models and the corresponding to these models theories.**
- C. **The characteristic features of propagation of waves while the waves being analyzed within the framework of the basic models on examples of simplest types of waves.**

Because the course of chapters-lectures is offered, then it consists naturally of separate chapters-lectures. Each chapter-lecture contains certain sequentially expounded fragment of the theory, which can be really proposed to the auditory during the time getting for the usual university lecture.

The book can be conditionally divided on **three groups**:

- I. **The necessary information on waves.**
- II. **The necessary information on materials.**
- III. **The analysis of basic types of mathematical models of materials and the characteristic properties of simplest mechanical waves from the position of similarity and distinction of wave propagation depending on the basic properties of materials, which are displayed while materials being deformed: elasticity, thermoelasticity, viscoelasticity, elastoplasticity, piezoelectricity, magnetoelasticity.**

The third group is divided on six subgroups, each of which is devoted to one of the most common types of models corresponding to certain theory – the theory of elastic waves, the theory of thermoelastic waves, the theory of viscoelastic waves, the theory of elastoplastic waves, the theory of piezoelectric waves, the theory of magnetoelastic waves.

Each subgroup contains the chapters either with the short treatment of basic positions of the particulate model and the corresponding to the model theory, which are necessary for understanding the wave motion features, or with the detailed enough treatment of the characteristic problem on wave propagation.

Each chapter-lecture contains at the end the comments to problems considered, the bibliography (the list of books and original articles on the chapter subject for further reading), and the list of question, which will enable the reader to turn to the cited books and to study more deeply some aspect of the chapter.

Comments are concentrated mainly on fragments not reflected sufficiently in the chapter-lecture and important for the in-depth study.

The bibliography is intended to show the wealth of the problems in hand (mainly, the wave and theoretical models problems, and in a few chapters, only), on the one hand, and to help in the in-depth study, on the other hand.

The questions are the main goal to formulate the starting point for in-depth discussion some aspect of the chapter-lecture. The depth of discussion will depend on the reader and his intensions.

Waves and materials are the key words in this book. Let us start therefore with studying the waves and materials from the general positions of modern physics.

1.1 Waves in the world around

The abstractly formulated scientific view on a motion has been expounded in encyclopedias: the motion is one of the forms of the matter existence. The second widespread maxim states that in fact the entire world is in a state of motion.

The wave motion as a subclass of motion in general is observed very frequently. As a result of the observation, a description of the wave phenomenon is becoming, as a rule, well known. It is considered sometimes that the description characteristics do not need a theoretical conception. Though the last one has always to give rise to doubt. The fact is that in such a description some criterion of distinction of wave motions from other motions is present deliberately or not. Practically everyone has seen waves on water, sand or somewhere else. And it going seems that it is not very difficult to determine purely by the description that we are observing the waves.

Waves are very various in their manifestations (see books in **Further reading**): besides the well-known waves on water or in air one may observe visually shock, explosion, seismic, optic, electromagnetic, magnetoactive, interferential, radio, waves in glaciers, high-flood waves and rolling waves in rivers, waves in transportation streams in tunnels, chemical waves of a metabolism, waves in processes of river and see sediments, epidemic and population waves et cetera.

For all these waves of diverse nature, some common attributes may be specified:

the observed in certain place of space disturbance must propagate with a finite velocity to some other place of this space; as a rule, the process must be close to oscillatory, if it is observed in time.

Note F.1. A motion is assumed as oscillatory, when it takes place in the neighbourhood of some fixed state, is restricted in its variation from this state, and is repeated in most cases.

It is universally recognized that any wave observation, which extends beyond the limits of daily earthly description, must be associated with a theoretical scheme. First of all, this scheme gives to the space, in which waves propagate, some properties. For example, traditional physical schemes are based on the continuum concept, when a set of scalar, vector, and tensor quantities is associated with each geometric point in the actual space, and deals with so called physical fields. In selecting the fields, the physical medium (acoustic, elastic, electromagnetic, etc), the motion on which is mathematically described using equations with partial derivatives - equations of mathematical physics is fixed by this very same thing.

So, in contrast to the descriptive approach to wave phenomena, which as needs the knowledge of wave attributes only,

**in the so called scientific-cognitive approach
some initial theoretical scheme is always presented and used.**

Every theoretical scheme for wave description has to contain at least two independent parameters - time and space coordinates. Continuum physical schemes establish the relations between fields depending on these parameters. As a result, differential equations are derived, among solutions of which must be also such ones, which describe waves.

Note F.2. One is well-known that all set of solutions of partial differential equations can be found not for each case; therefore, in physics these solutions are found, which are needed for physicists.

Wave analysis is divided by different indications.

For example, such a characteristic of the solution as its smoothness was turned out to be critical in theoretical wave analysis. Knowledge of the solution smoothness is equivalent to knowledge of its continuity or discontinuity, and also their quantitative estimates (types of discontinuities, order of continuity, etc). The situation when waves corresponding to discontinuous and continuous solutions are studied separately was formed long ago. The delimitations are occurred as a result of the difference in the physical interpretation of mechanisms of the excitation of waves and process of wave motion. So, as if two branches of studying the one and the same physical phenomenon are existing.

The branch of study associated with discontinuous solutions treats a wave as a singular surface motion relative to some given smooth physical field. That is to say, wave motion is understood as motion in the space of a field jump on a given surface.

The second branch is associated with continuous solutions describing a continuous motion. Two classes of waves are isolated here. **Hyperbolic waves** are obtained as solutions of differential equations of hyperbolic or ultra-hyperbolic types and, consequently, are clearly defined by the type of equation. It is also possible to speak of another type – **dispersive waves**. This type is defined by the form of solution.

Definition F.1. It is claimed that a medium, in which the wave propagates, is dispersive and the wave themselves is dispersive, if the wave is mathematically represented in the form of familiar function F of the phase $\varphi = kx - \omega t$ (x is the spatial coordinate, k is the wave number, ω is the frequency, and t is time), and if the phase velocity $v = \omega/k$ of the wave depends nonlinearly on frequency. Occasionally, it is more convenient to fix the dispersivity in the form of nonlinear function $\omega = W(k)$.

Note F.3. Solutions of the type $u = F(kx - \omega t)$ are admitted not only to hyperbolic differential equations, but parabolic one, and also some integral equations.

Note F.4. The criteria of hyperbolic and dispersive waves are not mutually exclusive; hyperbolic and dispersive waves are therefore encountered simultaneously. Among other things, the majority of the waves in materials with the microstructure discussed in this book are precisely these kinds of waves.

This book deals with continuous waves in solids. As it will be shown later, the structural approach in the wave analysis displays some new types of waves. It is based on the attribute consisting of dependence of the wave phase on some wave characteristics.

Therefore, some new classification of elastic waves in solids can be proposed and the question of another classification arises naturally.

Let us fix here the classification standard in physics and differing from the mentioned above **hyperbolic - dispersive** by the kinematic attribute. It consists of four types:

1. **solitary waves or pulses - sufficiently short in time and irregular locally given in a space disturbances;**
2. **periodic (most often, harmonic or monochromatic) waves, which are characterized by disturbances in all the space;**
3. **wave pockets - regular locally given in a space disturbances;**
4. **trains of waves - harmonic wave pockets.**

1.2 Materials in the world around

Let us consider now the materials from the quite general point of view on materials as the physical substance.

Definition F.2. The physical substance is defined as the aggregate of discrete formations, which have the rest mass (atoms, molecules, and more complicate formations of them).

The state of aggregation and the state of phase of the substance are distinguished.

Four states of aggregation are known: gaseous, plasmic, liquid, solid.

Definition F.3. The **gaseous state** is characterized by translatory, rotational, and oscillation motions of molecules. Distances between molecules are large, that is, the density of molecule packing is not high.

Definition F.4. The **plasmic state** is differed from the gaseous one by that it is an atomized gas with the equal concentrations of positive and negative charges. It singles out only for this purpose that, as a lot of people believe, the substance in Universe consists of just plasma.

Definition F.5. The **solid state** is characterized by only oscillatory motions of molecules near immovable centers of equilibrium with frequencies $10^{13} \div 10^{14}$ oscillations per second. Translatory and rotational motions are absent. Distances between molecules are small, that is, the packing density is high.

Definition F.6. The **liquid state** is close to solid by character of packing, but it is close to the gaseous one by character of molecule motions.

The phase states are distinguished by order in the reciprocal placement of molecules. There are three such states: crystalline, liquid, gaseous.

Definition F.7. The **crystalline phase state** is characterized by the ‘far’ order in the placement of molecules, when the order is kept on distances, exceeding the molecule dimensions $10^2 \div 10^3$ times.

Definition F.8. The **liquid phase state** is the state with the “near” order in the placement of molecules, when the putting in order is observed only in immediate “nearness”, that is, on distances of few molecules. On larger distances the placement is unpredicted. Often, for this state the term **amorphous state** is used.

Definition F.9. Solid amorphous substances are called **glasslike** ones.

The glasslike state differs essentially from the liquid amorphous state, and it is marked out sometimes as the isolated state.

The gaseous state of aggregation and the gaseous phase state coincide practically.

**The solid state of aggregation corresponds to two
different phase states: crystalline and glasslike.**

Definition F.10. **Materials** are defined as substances in the solid state of aggregation.

The materials traditionally include the machine-building and building materials, polymer and composite materials etc. Recently materials are divided on 5 types:

1. **Metals and alloys.**
2. **Polymers.**
3. **Ceramics and glasses.**
4. **Composites.**
5. **Natural materials: wood, leather, cotton /wool/silk, bone.**

The mentioned in definitions above **solidity** is treated in mechanics as the property of any body to have some **configuration**, for which the body gives preference. A change of the body shape relative to the configuration is measured by **the deformation**. Within the framework of axiomatic procedure in constructing the mechanics of materials, these two notions (configuration, deformation) are defined exactly. This accuracy is reached within the frame of thermodynamics of material continua.

So, classical physics thinks of a solid body as a system of a great number of coupled and interacted particles, which has been previously called the discrete formations. It turns out that the description of the changing form of body by taking into account the motion of each particle is too complicate problem. Besides that, this description is inexpedient in classical macro-mechanics, since knowledge of an individual motion of the particle (their number in 1cm^3 has the order 10^{22}) gives a picture of the micro- or nanoscopic motion, whereas

**in many cases the changing of body form can by studied successfully
as a manifestation of the macroscopic motion.**

The macro-description of materials was predominant in mechanics of materials up to 20 century, when meso-description and micro-description were proposed and developed (the first one owing mainly the in-depth analysis of metals; the second one owing to the wide fabrication and application of composite materials in the second half of 20 century). Both new descriptions are based on understanding the materials as having the internal structure of meso- and microlevel substance and on assumption that this structure can not be neglected in mechanical processes studying in meso- and micromechanics. Recently the thriving development of nanomechanics of materials is observed and this fact will be discussed in next lectures.

The modern mechanics of materials is divided on macromechanics, mesomechanics, micromechanics, and nanomechanics.

Comments

Austrian Emperor and Hungarian King Franz Jozeph Habsburg I has been lived the long life (1830 -1916) and had many strangenesses. One of them consists in that in the evening of life he likes, when someone asked him about the secret of his longevity. He answered at once on this question that he lives so long because he is reading all the life the one and the same book: The Infantry Field Manual.

This wisdom can be interpreted in present situation as the advice to choose among a plenty of cited books on waves one only book and first to become familiar with this book, then only to see other books.

The advice is based on that a majority of the good written books is created according certain concept, which is realized all over the book and in all the book fragments. This uniformity creates the conditions for equal understanding of the book topic.

Please click the advert





it's an **interesting** world

Get under the skin of it.

Graduate opportunities
Cheltenham | £24,945 + benefits

One of the UK's intelligence services, GCHQ's role is two-fold: to gather and analyse intelligence which helps shape Britain's response to global events, and, to provide technical advice for the protection of Government communication and information systems. In doing so, our specialists – in IT, internet, engineering, languages, information assurance, mathematics and intelligence – get well beneath the surface of global affairs. If you thought the world was an interesting place, you really ought to explore our world of work.

www.careersinbritishintelligence.co.uk

Applicants must be British citizens. GCHQ values diversity and welcomes applicants from all sections of the community. We want our workforce to reflect the diversity of our work.







The concept is open to injury, because not the whole of people is reasonably apprehending the uniformity – it isn't like some people. It is known that in one's time Stravinsky expressed the caustic remark that Vivaldi has been written a thousand times the one and the same violin concerto.

The book in hand is constructed also on the one concept – the exposure of similarities and distinctions in propagation of waves in materials, which being deformed manifest different mechanical properties: the property of elasticity or this property plus some other basic property (viscosity, plasticity et cetera).

It seems to be not out of place to remember the ancient maxim “**Qui bene distinguit – bene docet**” (Who distinguishes well – teaches well”).

The second comment is associated with division of mechanics of materials into macro-, meso-, micro-, and nanomechanics.

It is necessary to remember that sometimes such a division is sufficient conditional, because the one and the same material can be the subject for studying of different mechanical phenomena, which need to use different models from mentioned above four divisions of mechanics of materials of different scale levels. For example, when the waves of KHz range frequencies being studied, then it becomes usually to be expedient to consider these waves within the framework of macromechanics, whereas the waves of MHz range frequencies can be more adequately considered within the framework of micromechanics.

Further reading

The proposed list of books on waves of different kinds is extraordinary. In this book, the similar list will be cited once more as applied to materials in chapter-lecture 1 and to waves in materials in chapter-lecture 3 only. In next chapters, the bibliography will be essentially shorter, but sufficient for the self-dependent extending the knowledge.

1. Ablowitz, VJ & Segur, H 1981, *Solitons and the Inverse Scattering Problem*. SIAM, Philadelphia.
2. Akhiezer, AI, Bariakhtar, VG & Peletminsky, SV 1967, *Spin Waves*. New York: Academic Press.
3. Alexandrov, AF, Bogdankievich, LS & Rukhadze, AA 1990, *Oscillations and Waves in Plasma Media*. Moscow University Publishing House, Moscow. (In Russian)
4. Beyer, RT 1974, *Nonlinear Acoustics*. Naval Sea Systems Command Report, DC, Washington.
5. Bloembergen, N 1965, *Nonlinear Optics. A Lecture Note*. W.A. Benjamin, Inc., New York-Amsterdam.
6. Boulanger, P & Hayes, M 1993, *Bivector and Waves in Mechanics and Optics*. Chapman & Hall, London.
7. Crawford, FS Jr 1968, *Waves*, Berkeley Physics Course, Vol.3. Mc Graw-Hill Book Company, New York.
8. Drumheller, DS 1998, *Introduction to Wave Propagation in Nonlinear Fluids and Solids*. Cambridge University Press, Cambridge.
9. Hippel, AR 1954, *Dielectrics and Waves*. John Willey & Sons, New York.
10. Keilis-Borok, VI 1960, *Interferential Surface Waves*. AN SSSR Publ. House, Moscow. (In Russian)
11. Levine, AH 1978, *Unidirectional Wave Motions*. North-Holland, Amsterdam.
12. Levshin, AL 1973, *Surface and Canal Seismic Waves*. Nauka, Moscow. (In Russian)
13. Lighthill, MJ 1978, *Waves in Fluids*. Cambridge University Press, Cambridge-London.
14. Morse, PM & Ingard, KU 1968, *Theoretical Acoustics*. Mc Graw Hill, New York.
15. Rabinovich, MI & Trubetskov, DI 1984, *Introduction to Oscillation and Wave Theory*. Nauka, Moscow. (In Russian).

16. Schubert, M & Wilgelmi, B 1971, *Einführung in die nichtlineare Optik, Teil I, Klassische Beschreibung*. BSB BG Teubner Verlagsgesellschaft, Leipzig. (In German)
17. Scott, AC 1970, *Active and Nonlinear Wave Propagation in Electronics*. Wiley-Interscience, New York.
18. Selezov, IT & Korsunsky, SV 1991, *Nonstationary and Nonlinear Waves in Electroconducting Media*. Naukova Dumka, Kiev.(In Russian)
19. Shen, YR 1984, *The Principles of Nonlinear Optics*. John Wiley and Sons, New York.
20. Skudrzyk, E 1971, *The Foundations of Acoustics. Basic Mathematics and Basic Acoustics*. Springer-Verlag, Wien-New York.
21. Svirezhev, JM 1989, *Nonlinear Waves. Dissipative Structures and Catastrophes in Oecology*. Springer, Berlin.
22. Vinogradova, MB, Rudenko, OV & Sukhorukov, AP 1990, *Theory of Waves*. Nauka, Moscow. (In Russian).
23. Whitham, J 1974, *Linear and Nonlinear Waves*. Wiley Interscience, New York.
24. Yariv, A 1967, *Quantum Electronics*. John Wiley and Sons, Inc., New York.
25. Zeldovich, JB Barenblatt, GI, Librovich, VB & Makhviladze, GM 1980, *Mathematical Theory of Combustion and Detonation*. Nauka, Moscow. (In Russian)

Questions

- F.1. By which attributes the oscillations and the waves are distinguishing?
- F.2. If you are observing two waves of different nature (for example, the waves on sand and the traffic waves), then which common attributes can be fixed?
- F.3. Which kinds of discontinuities are considered usually, when waves being studied within the concept of discontinuous ones?
- F.4. Exists in the nature the clear division of the substance on fluids and solids?
- F.5. Which substances are the subject of study in rheology?

Please click the advert



HORIZONS UNIVERSITY

In Paris or Online

International programs taught by professors and professionals from all over the world

BBA in Global Business
 MBA in International Management / International Marketing
 DBA in International Business / International Management
 MA in International Education
 MA in Cross-Cultural Communication
 MA in Foreign Languages

Innovative – Practical – Flexible – Affordable

Visit: www.HorizonsUniversity.org
 Write: Admissions@horizonsuniversity.org
 Call: 01.42.77.20.66

www.HorizonsUniversity.org



1 On materials. Preliminary

Continualization and homogenization procedures. Material continuum. Body. Structural mechanics of materials. Macromechanics, mesomechanics, micromechanics, nanomechanics. Composite materials.

Mechanics of materials as the part of physics of materials is studying the mechanical phenomena in materials and is dealing mainly with continuum models of materials. As it is well-known, both classical and modern physics assume the materials as the having discrete structure system of formations. A transition from the discrete system to the continuum one is reached using the procedure of continualization – a replacement of the volume occupying by the discrete system on the same volume occupying by the continuum with certain continually distributed physical properties.

Thus, the continualization establishes some correspondence between a piece of real solid body, occupying the volume V and having a complicate discrete internal structure and fuzzy external boundary, and a piece of the fictitious body of the same volume $V \subset \mathbb{R}^3$ (and, of course, the same configuration with now fixed external boundary), to each point of which the set of averaged physical characteristics is attributed.

The first of these characteristics, which according to the definition form the fields and therefore are called **the field of thermodynamical characteristics**, is the mass density ρ .

Definition 1.1. The geometrical area $V \subset \mathbb{R}^3$ (finite or infinite), in which the field of mass density $\rho(x, y, z)$ is given, is called in physics **the material continuum or the continuum**.

Definition 1.2. A notion of **body** is defined as the material continuum in the regular area of a space.

**But the notion of material continuum only is not sufficient
for description of the deformation process in solid bodies.**

Usually, **the continuum is equipped**, that is, the scalar field of mass is complemented by three fields: vector field of displacements and tensor fields of strains and stresses. Within the frame-work of axioms of rational mechanics, these three notions (fields) are defined exactly.

It can be noted that the procedure of continualization of discrete system in hand gives the continuum description of the piece of material in hand. This piece can be considered separately. In this case it can be treated as a homogeneous or inhomogeneous material. The material can consist also of many continuum pieces (for example, a granular composite material consists of the matrix with embedded granules). In this case the discrete system is extended to a piece-wise homogeneous material. Two basic approaches are then used: the exact approach based on application of the equations of continuum mechanics to each separate homogeneous piece and then on taking into account the interaction of pieces at interfaces; the approximate approach based on the procedure of averaging of mechanical parameters of all the piece-wise composition.

The procedure of homogenization (averaging) consists in that usually a cube, dimensions of which are many times less of the body, is chosen in the space area, which the inhomogeneous body (material) occupies. This cube must include the sufficient great number of pieces (otherwise, the procedure of averaging becomes false).

Definition 1.3. The chosen in that way cube (volume) is called **the representative cube (volume)**.

The center of this cube is usually the point, to which all averaged properties of the cube are attributed. As a result, the homogeneous material with continuum characteristics is considered. The important role of **the characteristic size of inhomogeneities** of the material should be mentioned. This quantity with length dimension is also called the characteristic size of internal structure.

Two restrictions on this new parameter are the most known.

Restriction 1. For wave problems, the characteristic size of internal structure must be at least on one order less than the wave length.

Restriction 2. For problems with varying surface loading, the characteristic size of internal structure must be at least on one order less than the characteristic length of variability.

These restrictions in continualization procedure can be considered as the concrete displaying of the general requirement:

the elementary volume should be a representative one.

So, the characteristic size of internal structure can't be commensurable with the scale of averaging.

Definition 1.4. This condition is called the condition of effective homogenization.

Note 1.1. The final goal of the averaging procedure is the effective description of material as the material continuum. Also this procedure is the fundamental one in the structural mechanics.

The structural mechanics of materials is understood as the division of mechanics of materials, in which the basic relationships include the parameters of the internal structure of materials.

Now, in dependence on sizes of granules (fibers, sheets) in the internal structure of materials, the structural mechanics can be divided on **macromechanics, mesomechanics, micromechanics, and nanomechanics**.

Taking into account the results of numerous publications, the following classification **of the admissible range of changing the characteristic size of inhomogeneities (particles) in the internal structure of materials**

1. **macro:** $10^{-2} - 10^{-5}$ m (from 1 cm till 10 μ m).
2. **meso:** $10^{-3} - 10^{-8}$ m (from 1 mm till 10 nm).
3. **micro:** $10^{-4} - 10^{-8}$ m (from 100 μ m till 10 nm).
4. **nano:** $10^{-7} - 10^{-9}$ m (from 100 nm till 1 nm).

Let us stop on nanomechanics as the very new and attractive part of mechanics of materials.

To begin with, nanomechanics arose as a result of formation and developing of nanophysics and nanochemistry.

Nano- (from the Greek word for “dwarf”) means one thousand millionth of a particular unit. The prefix “nano” in the words “nanotechnology” and “nanomechanics” pertains to a length of 1 nm ($1 \cdot 10^{-9} m$).

The new classification of materials including nanomechanics is shown schematically on Fig. 1.1.

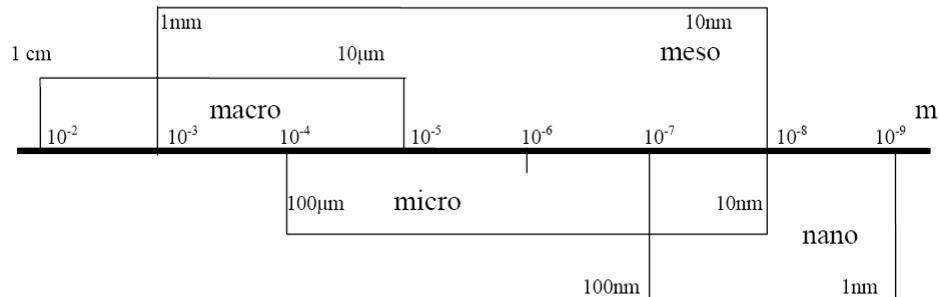

Fig. 1.1. Classification of internal structure of materials by the attribute of admissible size of particles

Richard Feynman was the first to predict the development of nanotechnology. In his well-known lecture *There's Plenty of Room at the Bottom*, read at a meeting of the American Physical Society in 1959, Feynman formulated the basic principle of nanotechnology: **“The principles of physics, as far as I can see, don’t speak against the possibility of maneuvering things atom by atom”.**

Today we may state that at that time there were no tools to analyze the nanostructure of substance. Electronic microscopes, the main tool to deal with nanomaterials, have been invented fairly recently. The first scanning electronic microscope was developed in 1942 and became available in the 60s. The scanning tunneling microscope and the atomic force microscope, used to study nanomaterials, were created in the 80s (first, by Binnig and Rohrer (IBM Zürich) in 1981 and the latter, by Binnig, Quate, and Gerber in 1986; the inventors of both microscopes were awarded the Nobel Prize in Physics in 1986). Through these microscopes, the surface of a material can be seen at a nanometer scale. That is what favored the success of many experiments on nano-materials.

Eric Drexler is reckoned the second predecessor of nanotechnology. He once organized a new division of technology and wrote that nanotechnology is the principle of manipulating atoms by controlling the structure of matter at molecular level and that “this road leads toward a more general capability for molecular engineering which would allow us to structure matter atom by atom”.

Definition 1.5. Atom-by-atom construction is now called the molecular nanotechnology.

Nanotechnology as a whole can be understood as research and technology development at the atomic, molecular or macromolecular levels in the length scale of approximately 1–100 nm range, to provide a fundamental understanding of phenomena and materials at the nanoscales and to create and use structures, devices and systems that have novel properties and functions because of their small and/or intermediate size.

Note 1.2. In some particular cases, the critical length scale may be under 1 nm or be larger than 100 nm. The last case includes the composites (reinforced by nanoformations polymers), which have the unique feature at 200-300 nm as a function of the local bridges or bonds between nanoformations and the polymer matrix.

The primary concept in theoretical interpretation of nanomaterials includes the idea that all materials are composed of particles, which in turn consist of atoms. This concept coordinates well with the classical concept. The next statement – these particles may be visible or invisible to the naked eye, depending on their size – introduces something novel into classical understanding the materials. The structural mechanics of materials assumed the size of granules from nanometers to centimeters and so forth (in rock mechanics, for example).

Many people believe that nanomaterials as materials whose internal structure has nanoscales dimensions are something new to science. However, it was relatively recently realized that some formations of oxides, metals, ceramics, and other substances are nanomaterials. For example, ordinary (black) carbon was discovered at the beginning of 1900. Fumed silica powder – a component of silicon rubber – is a nanomaterial too. It came into commercial use in 1940. However, only recently it becomes clear that the particles constituting these two substances have nanoscale dimensions.

Note 1.3. The particle size is not the only characteristic of a nanoparticle, nanocrystal, or nano- materials. A quite important and specific property of many nanomaterials is that the majority of their atoms localize on the surface of a particle, in contrast to ordinary materials where atoms are distributed over the volume of a particle.

It should be discussed here especially the carbon nanoparticles as components used in the next numerical modeling nanocomposites. Science has long been aware of three forms of carbon: amorphous carbon, graphite, and diamond. The highly symmetric molecule of carbon C_{60} was discovered in 1985. It has a spherical form, resembling a football, with carbon atoms on the surface and contains 60 atoms in five-atom rings separated by six-atom rings. These molecules were named fullerenes and have come to be studied fruitfully. Scientists who studied fullerenes were awarded the Nobel Prize in Chemistry in 1997. Since then the number of discovered kinds of fullerenes has increased considerably, reaching many thousands to date.

What is more important is that fullerene molecules form carbon nanotubes, which may be considered relatives of graphite. Nanotubes can be thought of as graphite lattices rolled up into a tube – they are the molecules with a very large number of atoms $C_{10000} - C_{1000000}$. Nanotubes differ in length, diameter, and the way they are rolled. The internal cavities may also be different and tubes may have more than one sheet. Atoms at the ends of a fullerene molecule form the “hemi-spherical caps”. Sheets may be rolled differently, forming zigzag, chiral, and armchair structures.

Note 1.4. Two types of nanotubes are distinguished: single-wall and multi-wall nanotubes.

It should also be noted that nanotubes are technologically advantageous over ordinary carbon fibers: the former are produced from colloidal solutions at room temperatures, whereas the latter need high temperatures.

So, we can write the common experience that the uniting property of all known nanoparticles is their dimensions; and their internal structure may vary considerably. Not only does the mentioned have a high level of surface localization, but also various features in the chemical-physical structure of nanoformations – their intermediate position between macro-world and atomic world – manifest themselves as their peculiar mechanical properties. Their mechanical characteristics exceed considerably those of traditional materials.

Today's study of the mechanical behaviour of nanoparticles, nanoformations, and nanomaterials are at an early stage; *i.e.*, only external manifestations of mechanical phenomena are detected, but their mechanisms are not studied enough.

In closing this short introduction into nanomechanics, it seems pertinent to recall a discussion on mechanical properties of new materials organized in The United Kingdom (June 6-7, 1963), and published in the *Proceedings of Royal Society* in 1964. In the concluding remarks, Professor Bernal, one of the organizers, said:

Here we must reconsider our objectives. We are talking about new materials but ultimately we are interested, not so much in materials themselves, but in the structures in which they have to function.

The nanomechanics faces the same challenges that micromechanics did 40 years ago and that John Bernal described so eloquently.

Please click the advert



Nido

Luxurious accommodation

Central zone 1 & 2 locations

Meet hundreds of international students

BOOK NOW and get a £100 voucher from voucherexpress

Nido Student Living - London

Visit www.NidoStudentLiving.com/Bookboon for more info.

+44 (0)20 3102 1060

Download free ebooks at bookboon.com

Let us return now to the structural mechanics and consider the basic elements of the theory of composite materials as that theory of materials which exerts great influence upon structural mechanics.

Classical mechanics of materials was used to divide materials into two classes: homogeneous and heterogeneous ones.

Definition 1.6. The **homogeneous** materials are understood as materials with internal structure of atomic-molecular character (with characteristic size of the structure close to atoms or molecules).

It means that such materials have the discrete molecular structure, which is mainly changed using the procedure of continualization to the model representation by the homogeneous continuum.

Definition 1.7. The **heterogeneous** materials are understood as materials with internal structure essentially more than molecular-kinetic sizes (sizes of molecules, crystal lattice *etc*).

It means that these materials consist of components (phases) and have the macroscopically inhomogeneous internal structure. As a rule heterogeneous materials are modelled by a piece-wise homogeneous continuum, which assumes that each component of internal structure is also modeled by homogeneous continuum. Thus, as it was mentioned above, the procedure of continualization is applied in this case not to the material as whole but to separate components of the material. The composite materials are the typical representatives of heterogeneous materials. It can be distinguished by the natural and artificial composites.

Definition 1.8. The composite materials are conventionally defined as consisting of a few components (phases) with differing physical properties. As a rule, these components alternate many times in the space. The way of alternating, conditions on the interface, a geometrical form and physical properties of components define the internal structure of the composite.

In real composites the internal structure is at best close to a periodic one. The most difficult in continuum description are the processes taking the place at an interface. Macro-, meso-, and micromechanics considered these processes practically from one and the same point of view based on the general physics conceptions. Nanomechanics introduces into this problem the new features associated with intermediate states of interface processes between general physics laws and quantum physics laws.

In the continuum modelling, all problems of composite interface are reflected in formulations of boundary conditions between matrix and fillers. Thus, the novel problem of nanomechanics of composites distinguishing this branch and the old branches (macro-, meso-, micromechanics of composites) consist in an adequate formulation of above mentioned boundary conditions.

The next important distinction of nanomechanics of composites consists in novel for mechanics of materials with very high values of main mechanical properties of nanofillers (for example, extremely high values of Young modulus).

As the most important similarity of all four branches of structural mechanics of materials the fact of applicability of common for all branches continuum models can be considered.

Mechanics of composites is concentrated on the specially designed materials. As a rule, the internal structure of composite materials assumes the jumping (stepwise) change of properties of components (phases) on interfaces and presence of the soft and stiff components. The stiff component is considered as the arming or reinforced one and is usually called the filler whereas the soft component is conditionally called the matrix (the binder). A difference in some mechanical properties (for example, Young modulus) of composite components can reach 100 through 1000 and more times.

Definition 1.9. In the case when some areas of free space (voids) between components exist, these areas are treated as pores representing one more component, and such a composite is called the porous composite.

The most commonly known and used composites are granular (granules as reinforcing fillers), fibrous (fibres as reinforcing fillers), and layered (thin layers-sheets as reinforcing fillers) composites.

Complexities in analytical description of mechanical phenomena in composite materials have resulted in creation of approximate continuum models which, on the one hand, save the main physical properties of the system and, on the other hand, these models are quite simple and assume the analytical solutions for boundary problems.

At present, many different approximate models are proposed and well developed. They take into account the internal structure of materials, determine the necessary mechanical parameters and solve practically all important problems. These models can be divided on the structural models of different orders. The basic model (structural model of the first order) is based on assuming the material as a homogeneous continuum, mechanical properties of which should be determined on the base of standard tests. The internal structure of a composite is displayed here in the same way as it is done for engineering and building materials (steel, iron, wood or plastics). The properties which are found using the averaging procedure, depend on the basic parameters of internal structure. As it can be seen later, they are offered mainly in the form of algebraic relationships.

This circumstance permits to foresee on the stage of design the averaged properties of composite material. These abilities of the model together with technological possibilities for designing the engineering composites formed one of main directions in development of mechanics of composites. It must be noted that in most cases when the matter concerns the averaging properties, it is understood as working within the framework of classical continuum model of elasticity.

Comments

The comment concerns to one common feature of continualization and homogenization procedures. Let us start with that the main tool of these procedures is the representative volume. Most often it has the form of a cube with the side of essentially more less than the lesser sizes of a body, to which the procedure is applied. The feature is displayed in the case, when the body has the finite extent or is semi-infinite (for example, semi-space). While the cube being moved continuously over the body, then the average over the cube value of some thermodynamical parameters is evaluated, this value is assumed to be the value of the parameter at the cube center, and also this value is assumed to be the value of the parameter at the corresponding to the cube center point of new (fictitious) continuum.

But when the cube being gone to the boundary, it loses the property of representativeness: at least, starting with the distance to the boundary equal to the half of the cube side. Thus, the continualization and homogenization procedures are not well correct at the near-the-surface areas. In the wave theory, this means that the surface waves in continua can be described by the not quite correct models. In these cases the more adequate models should be applied.

The next comment is associated with the mechanical properties of materials. Ideally, each material should have as though the passport with its fixed physical properties. A long time, such data on materials were provided by experimental mechanics. Here the direct tests are of high value, because indirect tests need recalculation by use of some theoretical formula, sometimes not quite appropriate for concrete test. Nowadays, a practice of such indirect tests and theoretical calculations of mechanical properties of new materials is very popular, especially in nanomechanics.

Please click the advert

UNIVERSITY OF COPENHAGEN



Copenhagen Master of Excellence

Copenhagen Master of Excellence are two-year master degrees taught in English at one of Europe's leading universities

Come to Copenhagen - *and aspire!*

Apply now at
www.come.ku.dk

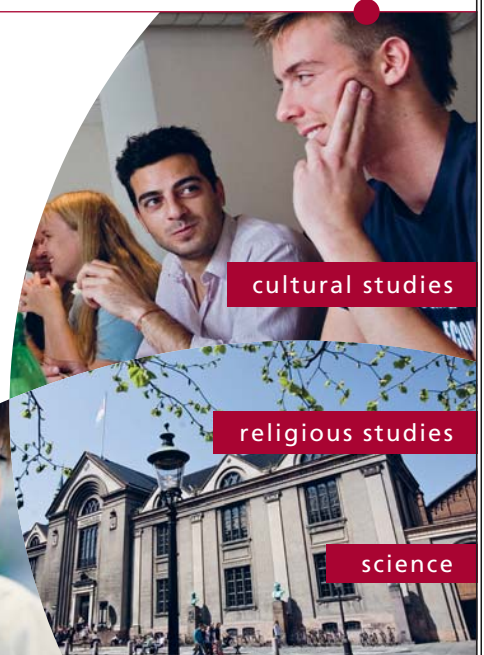

cultural studies

religious studies

science

Download free ebooks at bookboon.com

In this way obtained and reported in scientific publications data should be estimated with some criticism and scepticism. These data can be found in future not quite accurate.

This comment seems to be appropriate because analysis of waves in materials needs knowledge of physical properties of materials and takes the data on properties as the ascertained fact. And excessive caution will not harm – ‘**Et si nullus erit pulvis, tamen excute nullum**’ (If a dust is none, let shake off none).

Further reading

1. Ashby, MF 2005, *Materials Selection in Mechanical Design*, 3rd edn. Elsevier, Amsterdam-Tokyo.
2. Bhushan, B (ed) 2004, *Springer Handbook on Nanotechnology*. Springer Verlag GmbH and Co, Berlin-Heidelberg.
3. Broutman, LJ & Krock, RH (eds) 1974-1975, *Composite Materials*, In 8 vols. Academic Press, New York.
4. Buryachenko, VA, Roy, A, Lafdi, K, Anderson, KL & Chellapilla, S 2005. ‘Multiscale mechanics of nanocomposites including interface: Experimental and numerical investigation’, *Composites Science and Technology*, vol. 65, pp. 2435-2465.
5. Christensen, RM 1979, *Mechanics of Composite Materials*. John Wiley & Sons, New York.
6. Cleland, AN 2003, *Foundations of Nanomechanics. From Solid-State Theory to Device Applications*. Series Advanced Texts in Physics. Springer-Verlag, Berlin.
7. Daniel IM, Ishai O 2006, *Engineering mechanics of composite materials*, 2nd edn. New York-Oxford, Oxford University Press.
8. Gupta RK, Kennel E & Kim K-J (eds) 2010, *Polymer Nanocomposites Handbook*. CRC Press, Taylor & Francis Group, Boca Raton.
9. Guz, AN (ed) 1993-2003, *Mechanics of Composites*. In 12 vols. A.S.K., Kiev. (In Russian)
10. Guz, AN & Rushchitsky, JJ 2011, ‘On establishing foundations of mechanics of nanocomposites’, *Int. Appl. Mech.*, vol. 47, pp. 2-44.
11. Guz, AN & Rushchitsky, JJ 2011, ‘On nanocomposites of complex shape’, *Int. Appl. Mech.*, vol. 47, pp. 373-443.
12. Guz AN, Rushchitsky JJ & Guz IA 2010, *Introduction to Mechanics of Nanocomposites*. Akadempriodika, Kiev.
13. Guz IA, Rushchitsky JJ & Guz AN 2011 ‘Mechanical Models in Nanomaterials’. In: *Handbook of Nanophysics*. In 7 vols. Ed. KD Sattler. Vol.1. *Principles and Methods*. Taylor & Francis Publisher (CRC Press), Boca Raton, P.24.1-24.12.
14. Hull, D 1981, *Introduction to composite materials*. Cambridge University Press, Cambridge.
15. Jones, RM 1975, *Mechanics of composite materials*. McGraw-Hill, New York.
16. Kelly, A & Zweben, C (eds) 2000, *Comprehensive Composite Materials*, In 6 vols. Pergamon Press, Amsterdam.
17. Mai Y-W & Yu Z-Z (eds) 2009, *Polymer Nanocomposites*. Woodhead Publishing Limited, Cambridge.
18. Milne, I, Ritchie, RO & Karihaloo, B (eds) 2003, *Comprehensive Structural Integrity*, In 10 vols. Elsevier, New York.
19. Milton GW 2002, *The theory of composites*. Cambridge University Press, Cambridge.
20. Muhammad Sahimi 2003, *Heterogeneous Materials*. Springer, New York.
21. Nalwa, HS 2000, *Handbook of Nanostructured Materials and Nanotechnology*, Academic Press, San Diego.
22. Nemat-Nasser, S & Hori, M 1993, *Micromechanics: Overall Properties of Heterogeneous Materials*. North-Holland, Amsterdam.
23. Nigmatulin, RI 1992, *Foundations of Mechanics of Heterogeneous Media*. Academic Press, New York.
24. Ramsden, J 2010, *Nanotechnology*. Ventus Publishing ApS, Copenhagen.
25. Rushchitsky, JJ & Tsurpal, SI 1998, *Waves in Materials with the Microstructure*, S.P.Timoshenko Institute of Mechanics, Kiev. (in Ukrainian)
26. Tjong SC 2009, *Carbon Nanotube Reinforced Composites. Metal and Ceramic Matrixes*. Wiley-VCH Verlag GmbH & Co. KGaA, Weinheim.
27. Torquato, S 2003, *Random heterogeneous materials: microstructure and macroscopic properties*, Springer, New York

28. Tsai, SW & Hahn, HT 1980, *Introduction to composite materials*. CT Technomic, Wesport.
29. Vanin, GA 1985, *Micromechanics of Composite Materials*. Naukova Dumka, Kiev. (in Russian)
30. Wilde, G (ed) 2009, *Nanostructured Materials*. Elsevier, Amsterdam.
31. Wilson, N, Kannangara, K, Smith, G, Simmons, M & Raguse, B 2002, *Nanotechnology Basic Science and Emerging Technologies*. Chapman & Hall CRC, Boca Raton.

Questions

- 1.1. Formulate the distinction between continualization and homogenization.
- 1.2. Exist the fixed boundary among admissible size of inhomogeneities in materials of macro-, meso-, micro-, and nanolevel of internal structure?
- 1.3. One kind of heterogeneous materials are dispersive materials or suspensions (see 20,22,23,27 in the list of publications above). Point out the examples of real dispersive materials. Which sizes of dispersive particles are in these real materials?
- 1.4. Point out the examples of real granular (with granules as reinforcing fillers), fibrous (with fibers as reinforcing fillers), and layered (with thin layers-sheets as reinforcing fillers) composites.

Please click the advert

**THE BEST MASTER
IN THE NETHERLANDS**

Master of Science in Management

Kickstart your career. Start your MSc in Management in September, graduate within 16 months and join 15,000 alumni from more than 80 countries.

Are you ready to take the challenge? Register for our MSc in Management Challenge and compete to win 1 of 3 partial-tuition revolving scholarships worth €10,000!

www.nyenrode.nl/msc

NYENRODE
BUSINESS UNIVERSITEIT
A REWARD FOR LIFE

**BEST MASTERS
KEUZEGIDS MASTERS 2012 ***

*Keuzegids Higher Education Masters 2012, in the category of business administration

Download free ebooks at bookboon.com

2 On materials. Basic mechanical properties

Basic mechanical properties of materials: elasticity, plasticity, elastoplasticity, rigidplasticity, thermoelasticity, thermoplasticity, viscosity, viscoelasticity, viscoplasticity, diffusional elasticity, electroelasticity, magnetoelasticity. Thermodynamical theory of material continua. On the basic mathematical models

Let us start with repetition of the statement from the prior chapter: *mechanics of materials as the part of physics of materials is studying the mechanical phenomena in materials*. These phenomena reflect the main physical (mechanical) properties of materials. This means that in studying the mechanical waves the properties of medium of wave propagation is the primary fact for studying.

The deformation as a mechanical phenomenon can be meant as the tool for the study of mechanical properties.

Definition 2.1. The deformation of a solid is usually understood as a change of solid form (relative to some initial configuration and as a result of some causes, very often as a result of action of external forces).

The properties of materials, which are displayed by deformations, and constitutive features of the process of deformation are very diverse. Part of these properties underlies of particular classical theories of deforming the materials. Let us shortly describe these properties according to observations and experiments.

Elasticity

Definition 2.2. The property of elasticity consists in that the body practically simultaneously takes the initial configuration after removing the deformation causes.

In other words, if deformations are elastic, then they simultaneously vanish after removing the action of forces, caused the deformations.

This property, as also other properties, though, is displayed seldom in the pure form, that is, it is accompanied in real materials by a number of other properties. But in the most cases the elasticity is the main and prevailing property.

Plasticity, elastoplasticity, rigidplasticity

Properties above are considered as the most important technically.

Definition 2.3. If by some causes a body changes its configuration and doesn't go back to initial configuration after removing of these causes, then it is said that the plastic deformation is taken place.

In this case the body displays only the property of plasticity. Such a property means in fact for the body an absence of property to resist of external forces, that is, means the loss of the basic attribute of a solid.

In constructional materials, the property of elastoplasticity is observed the most frequently.

Definition 2.4. This property consists in that the deformation process is elastic up to some value of deformations, and by exceeding this value the process becomes the plastic one.

The property of rigid-plasticity is the limit case of the elastoplasticity property, its idealization.

Definition 2.5. It is displayed in that the body doesn't change its configuration up to some value of parameter, which fixes external action intensity (that is, the body is a rigid one), and when this value is exceeded the body becomes the plastic one.

Thermoelasticity, thermoplasticity

These properties are observed very easily, since the most part of solids are deformed when heated up, and they heat up when they are deformed.

For description of this phenomenon, the notion of temperature is introduced as a measure of the heat state.

Definition 2.6. If the change of temperature (that is, values of temperature in each point of the body, the temperature field) causes the elastic deformation and vice versa, then the property of thermoelasticity is displayed in the body.

Definition 2.7. If the change of temperature field causes the plastic deformation and vice versa, then the property of thermoplasticity is displayed in the body.

Viscosity

The property of viscosity is the most characteristic for fluids.

On the everyday level, the solid is differing from the fluid by the property of the first to conserve its form and an absence of this property for the second (besides the particular case of a bulk compression or other cases, which are reduced to the last one), and by the property of the fluid to flow.

In theoretical descriptions, this distinction is displayed in that if the motion of solids is described by deformations, then the motion of fluids is described by a velocity of deformations.

Definition 2.8. Fluids are differed by the property of internal friction: if this property is displayed slightly, then the fluid is called the ideal or perfect one, if strongly, then the fluid is called the viscous one.

So, the observation shows that solids possess also the property of viscosity. It is displayed in dependence of the arising during the body deformation internal forces not only on deformations (what is characteristic for solids), but also on the deformation velocities. The property of viscosity is displayed essentially only for isolated classes of materials, specifically for polymer materials.

Viscoelasticity, viscoplasticity

Let us use for explanation of properties of viscoelastic and viscoplastic deformations the theoretical scheme of description of elastic and plastic strains.

Note 2.1. The accurate description of strains and stresses will be presented later.

As it is adopted in mechanics, the notion of strains is supplemented by the notion of stresses. Stresses characterize the internal state of a body; physically they are linked with a field of acting inside the body forces and are some abstraction.

Mentioned above description concerns two phenomena, which are not peculiar to elastic strains and display presence in materials the property of viscoelasticity.

Definition 2.9. The first phenomenon, **the creep**, consists in that when a body is deformed with a constant rate up to certain values of stresses (generally speaking, arbitrary one), and this level is further conserved, then strains will increase.

Definition 2.10. The second phenomenon, **the stress relaxation**, consists in that if a body is deformed with a constant strain up to certain level of strains (generally speaking, arbitrary), and further these strains are conserved constant, then stresses will be decreased with time (relaxed).

In both cases the main property of elastic strains - their reversibility - is kept.

Definition 2.11. The property of viscoplasticity is displayed in materials in such a way that: the material possesses the creep property, the phenomenon of stress relaxation is absent, and the main property of plastic deformations, their irreversibility, is kept.

Viscoelasticity assumes that the material has simultaneously both the elasticity and the viscosity properties. The elastic materials are able to accumulate the energy without losses, that is, they are not able to dissipate energy. Whereas the viscous bodies (fluids) dissipate their energy and accumulate it only in the case of bulk compression. The property of viscoelasticity is such that the material possesses these two properties, to accumulate and to dissipate energy, simultaneously. The property of viscoplasticity can be commented in a similar way.

Diffusional elasticity

This property is displayed in a body, when the diffusion processes occur in a body.

Definition 2.12. The diffusion in physics is the movement of molecules due to the heat molecular motion.

That is, diffusion is one of mechanisms of mixing of two or more substances. For example, the diffusion of gold in solid lead is a topic studied very well.

Definition 2.13. It is said about the diffusional elasticity, when diffusion is a cause of body deformations and changes the stresses in the body, and, *vice versa*, a presence in the body of deformations and stresses cause the appearance in the body of diffusional fluxes.

This property is slightly similar to thermoelasticity property: the coupling of deformations with temperature is similar to the coupling of deformations with the substance concentration (basic physical relations have the same structure).

Electroelasticity

Properties of solids associated with the electromagnetic field effect on the deformation process and *vice versa* are to a certain extent differing from traditional mechanical properties: elasticity and plasticity.

This distinction consists in that elasticity and plasticity are in any event peculiar to all materials, whereas electroelasticity and magnetoelasticity are peculiar to certain classes of materials (to dielectrics, for example) and in several materials are not displayed in principle.

Definition 2.14. The effect of coupling of deformations and an electric field is called **the piezo-electric effect**. Respectively, the property of electroelasticity is displayed in such particular materials as **piezoelectrics**.

Magnetoelasticity

Coupling of the strain and magnetic fields is the essence of a property of magnetoelasticity.

Definition 2.15. This property reflects **the piezo-magnetic effect**, which consists in that the macroscopic magnetic moment arouses when a body is deformed.

Piezomagnetic effect was for the first time observed in antiferromagnetic, which was the compound of cobalt and iron. As the electroelasticity property, the property of magnetoelasticity is displayed in some narrow class of materials.

On next step, some basic facts from the thermodynamical theory of material continua should be presented.

Note 2.2. Two reasons are for this explanation – one is very practical and another is more abstract. First, the models of thermoelastic deformation and hence the features of propagation of waves in thermoelastic materials can be explained well within thermodynamical theory only. Second, the accurate constructing the classical theory of elasticity as well as the most complicate models will be better understood when the mentioned facts from thermodynamics will be known.

Some necessary facts from thermodynamics

So, in thermodynamics the material continua are studied. They are called thermodynamical systems. These systems are characterized by parameters of two kinds: intensive and extensive. The first kind doesn't depend on the mass (an amount of substance) of the system; the second kind is proportional to this mass.

Thermodynamical parameters are introduced as the collective characteristics of a system at large. They characterize the state of thermodynamical equilibrium of the system, that is, they are parameters of this state.

Definition 2.16. Physical state and number of state parameters are determined by the physical essence of the system. State parameters can have mechanical, electromagnetic, chemical and other nature.

The notion of the state of thermodynamical system is the fundamental one; the state is described in full by parameters of the state. Three of them, **absolute temperature T** , **entropy S** , and **internal energy U** , are given always.

Definition 2.17. It is said that a thermodynamical system is in **the equilibrium state**, if this state is not changed with time and actions on the system of external processes are absent.

Definition 2.18. If, in a system, some changes occur, then it is said that this system is in the state of **thermodynamical process**.

Equilibrium processes are marked out separately. These processes are peculiar by that the body goes slowly from one equilibrium state to other one. This gradual and slow transition permits to neglect the deviations from equilibrium, which are always presented in real processes.

Definition 2.19. Equilibrium thermodynamical processes have such a feature that a system can revert to the initial state, from which the process started. Such a process is called the **reversible** one. In all other cases, processes are called **irreversible processes**.

Destination MMU



Manchester
Metropolitan
University

MMU is proud to be one of the most popular universities in the UK. Some 34,000 students from all parts of the globe select from its curricula of over 1,000 courses and qualifications.

We are based in the dynamic yet conveniently compact city of Manchester, located at the heart of a sophisticated transport network including a major international airport on the outskirts. Parts of the campus are acclaimed for their architectural style and date back over 150 years, in direct contrast to our teaching style which is thoroughly modern, innovative and forward-thinking.

MMU offers undergraduate and postgraduate courses in the following subject areas:

- Art, Design & Performance
- Computing, Engineering & Technology
- Business & Management
- Science, Environmental Studies & Geography
- Law, Education & Psychology
- Food, Hospitality, Tourism & Leisure Studies
- Humanities & Social Science



For more details or an application form please contact MMU International.
email: international@mmu.ac.uk
telephone: +44 (0)161 247 1022
www.mmu.ac.uk/international

Please click the advert

The notion of state parameters is used in the study of reversible processes. For description of irreversible processes, the notion of a local equilibrium in each point of the system is usually introduced.

Let us consider three basic functions-state parameters.

Note 2.3. They are strong defining. For example, absolute temperature exists according to the law of heat equilibrium transitivity, and describes the heat equilibrium between being in heat contact bodies. Heat is transferred from a body with the greater temperature to a body with the lesser one.

The basic problem of thermodynamics is to study those processes, which are possible for this given system. Basic laws of thermodynamics, the energy law and the entropy law, form the base in this theory.

The first law of thermodynamics can be written as follows

$$dU = \delta Q + \delta A + \delta Z \quad (2.1)$$

The law (2.1) can be framed:

1. The internal energy of system U is the function of parameters of a system state, and it consists of a sum of the received by a system quantity of heat Q , of the done by a system work A , and of the energy Z , which is introduced into a system by the mass exchange.
2. The increment of internal energy is the total differential of parameters of a system state, and is a sum of increments of defined above number of heat, work, and energy.

Note 2.4. In the case of equilibrium processes these three increments can be represented as differential forms of state parameters, but they will not be total differentials.

Further, the differential forms $\delta Q, \delta A, \delta Z$ have to be represented in the explicit form through state parameters. Here, the second law of thermodynamics helps. It states for equilibrium processes:

the heat gotten by a thermodynamical process cannot be fully transformed into work.

In another definition, this law can be formulated in the form:

**for the equilibrium processes the entropy is some function of the state
and such a formula is valid**

$$\delta Q = TdS \quad (2.2)$$

Two laws (2.1) and (2.2) are often combined into the equation

$$dU = TdS + \delta A + \delta Z \quad (2.3)$$

The following problem consists in a certain particular representation of last two differential forms in (2.3), and also of internal energy by means of thermodynamical parameters. The choice of these parameters means the choice of particular model for a medium.

Mathematical models

It seems to be expedient to mention very shortly about the basic mathematical models taking into account the basic mechanical properties discussed at the beginning of the chapter-lecture. Each of these models will be considered more in depth in next chapters-lectures.

Of course, the most important is the property of elasticity. It is well-known that the classical theory of elastic deformation can be constructed without the thermodynamical notions. Chronologically (historically) it was done just in such a way. But as soon as we suppose that the cause of deformations can be temperature, electric or magnetic field, diffusion or something else, then the deformation process can be described only with the help of thermodynamics.

So, in order to construct the thermodynamically substantiated theories of deformation, there arises the necessity to formulate the axiomatically different models and to choose for each model its set of thermodynamical parameters.

Let us describe further this procedure for models of materials, which are based on above items of basic properties. It is logical to start with the classical model of elastic deformation caused by only forces of mechanical nature. The phenomenological procedure of constructing uses the balance equations for mass, pulse (momentum), momentum of a pulse (momentum of momentum), and energy.

Note 2.5. The complication of a deformation process and the necessary address to thermodynamics will effect writing the first and last balance equations, only.

The internal energy is namely that function, which needs the particular choice of thermo-dynamical parameters system. In the classical theory of elasticity is found to be sufficient the choice only one parameter – the strain tensor. It is the symmetric tensor of rank two, that is defined by six components, and internal energy depends actually on all six ones. This ascertaining is as now enough, since classical theory of elasticity will be commented later more precisely when studying the wave propagation processes. However, it is necessary to say here that the feature of processes of elastic classical wave propagation is in absence of any dissipation of wave energy, and this is laid in the model of this medium.

Note 2.6. The whole procedure of selecting for a material continuum and the necessary set of thermodynamical parameters is sometimes called the procedure of equipment of material continua.

Without a doubt, the accompanied by heating elastic deformation of materials is studied in the most detail from the point of view of thermodynamics. This model is based on the property of thermo-elasticity; the theory is called the theory of thermoelasticity. The thermodynamical parameters in the theory are **the absolute temperature and the strain tensor**.

It is expedient to focus on the phenomenon of **dissipation**, which is absent in classical elasticity and is the basic one in thermoelasticity. The axiom of dissipation states that there exists for each individual solid the limit value of a rate, with which heat can be transformed into energy without production of a mechanical work. This axiom is often written in the form of **Clausius inequality**

$$T\dot{S} \geq \dot{Q}, \quad (2.4)$$

If the notion of free energy F is introduced by the formula

$$F = U - TS, \quad (2.5)$$

then **the reduced Clausius inequality** for densities of functions F, A, T, S can be written

$$\dot{f} - \dot{a} + s\dot{\theta} \leq 0 \quad (2.6)$$

Usually, the notion of **internal dissipation** δ is also defined as

$$\delta = \theta\dot{s} - \dot{u} + \dot{a} \quad (2.7)$$

Then the statement that an internal dissipation can not be negative is called **the Planck inequality**

$$\delta \geq 0 \quad (2.8)$$

Please click the advert



Develop the tools we need for Life Science

Masters Degree in Bioinformatics

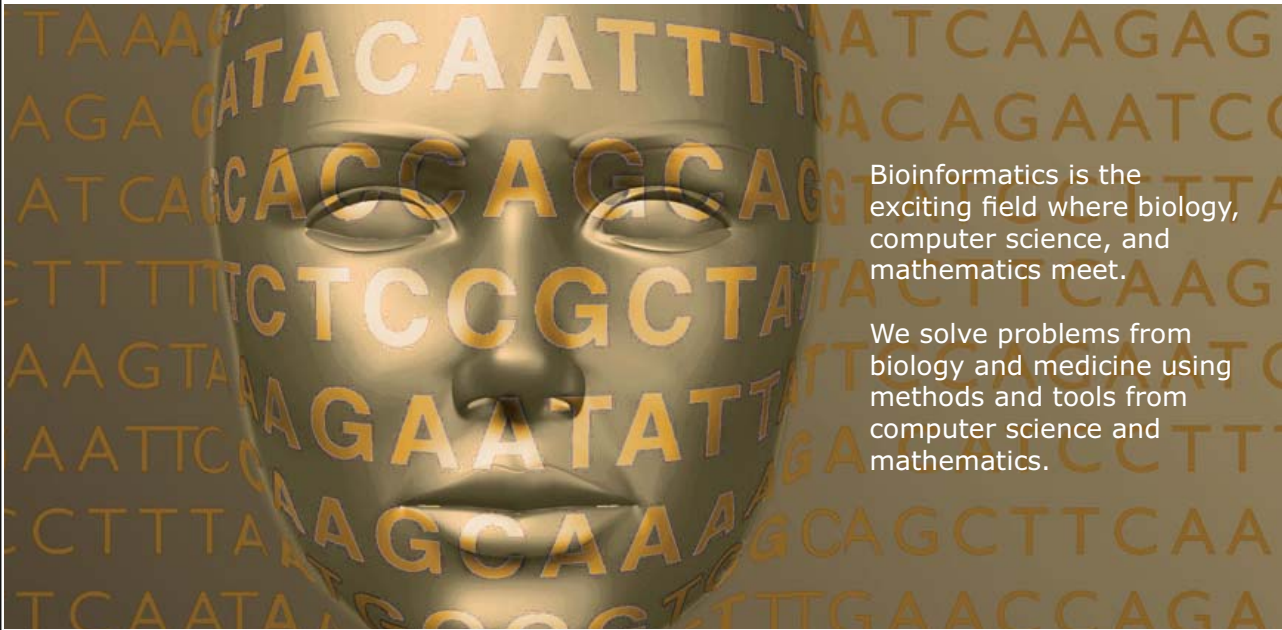

Bioinformatics is the exciting field where biology, computer science, and mathematics meet.

We solve problems from biology and medicine using methods and tools from computer science and mathematics.

Read more about this and our other international masters degree programmes at www.uu.se/master

Note 2.7. It has been proven that the internal dissipation is absent in the theory of thermoelasticity. But in all other theories of materials, which take into account not only the elasticity property, the dissipation is always present.

The next theories take into account the deformation field and some other thermodynamical parameters, and therefore they overstep the framework of classical thermoelasticity.

We can introduce the thermodynamical parameters in the theory of viscoelasticity, which studies the process of deformation with a memory of the history of deformation.

Definition 2.20. The model having memory of deformation is called the model of hereditary elasticity or, more generally, the model of elasticity with a long-range memory in contrast to the classical model elasticity with an infinitesimal memory.

We can assume that in this model the effect of temperature on strains is also taken into account. That is, let us consider the model of thermoelastic deformation with long-duration memory, the model of thermoviscoelasticity. The basic thermodynamical parameters in this model will be the same as in thermoelasticity. But the long-range memory will be displayed first of all in a presence of the internal dissipation, what fully agrees with a physical sense of the property of viscosity. One of the attributes of a viscous deformation is the mentioned above energy dissipation.

Note 2.8. It is quite obvious that the material does not store more energy only owing to its property to remember of deformation history. This knowledge of its history and the material displays not in increasing the energy, but in its separation, some part of energy will store in the form of internal dissipation.

The models of electroelasticity and magnetoelasticity are similar in choosing of thermodynamical parameters. These models use the classical thermodynamical parameter of mechanical nature – **the strain tensor** – and new parameter of electromagnetic nature – **the vector of electric intensity for an electro-elastic model and the vector of initial magnetic intensity for a magnetoelastic model**. One of the features of elastic and electromagnetic properties is that they don't permit the energy loss. Therefore models with a set of such properties are similar to the classical model of elastic deformation.

The model of diffusional elasticity is closely linked with thermodynamics. In some sense it is formed in the close interaction with thermodynamics. In fact, this model is the sole model of materials, which takes into account the mass exchange during a deformation process. The model therefore saves in writing of internal energy the classical thermodynamical parameter, strain tensor, but also needs the concretisation of the increment of energy of the mass exchange δZ .

It is known that in equilibrium processes the increment of energy of the mass exchange δZ is proportional to the increment of mass

$$\delta Z = \tilde{\mu} dM \tag{2.9}$$

Definition 2.21. The quantity $\tilde{\mu}$ is called **the chemical potential**.

When a system contains n distinguished particles the material point (representative volume) contains particles of all sorts, so that the representation (2.9) must be generalized

$$\delta Z = \sum_{k=1}^n \tilde{\mu}_k dM_k \quad (2.10)$$

When going on local quantities (densities) it becomes

$$\delta z = \sum_{k=1}^{n-1} \tilde{\mu}_k dc_k, \quad \sum_{k=1}^n c_k = 1 \quad (2.11)$$

Definition 2.22. The introduced quantities c_k are called **volume fractions** or **volume concentrations** or simply concentrations, they are those supplements to the strain tensor thermodynamical parameters, which permit to describe the model of diffusional elasticity. One essential point in this theory is that the concentrations are symmetric tensors of rank two.

Comments

The choice of thermodynamical state parameters is a difficult problem. The usual way in modern mechanics is called the phenomenological approach. According to the approach, parameters are strongly defined theoretically, further physical experiments for the determination of physical constants are described, and finally, the theory has to predict new phenomena.

For fundamental sciences, the necessity of attention to experiments and practice had been formulated as far back by Leibniz in his statement **theoria cum practica**. Today, it is understood as the necessity for any theory to amplify with experimentations. 200 years later, Boltzman, stated “**nothing is so practical as the theory**”. In 1926 in a talk between Werner von Heisenberg and Albert Einstein, Heisenberg stated that each theory, in its building, must correspond to only those observed by this time fact. Einstein answered, that it could be wrong to try to build the theory only on observed facts. Really, it happens the *vice versa*. **Theory determines, what we can observe.**

Further reading

1. Ashby, MF 2005, *Materials Selection in Mechanical Design*, 3rd edin. Elsevier, Amsterdam-Tokyo.
2. Atkin, RJ & Fox, N 1980, *An Introduction to the Theory of Elasticity*, Longman, London.
3. Dagdale, DS & Ruiz, C 1971, *Elasticity for Engineers*. McGraw Hill, London.
4. Eringen, AC 1967, *Mechanics of Continua*. John Wiley, New York.
5. Eschenauer, H & Schnell, W 1981, *Elasticitätstheorie I*, Bibl. Inst., Mannheim. (in German)
6. Fraeijs de Veubeke, BM 1979, *A Course of Elasticity*. Springer, New York.
7. Fu, YB 2001, *Nonlinear Elasticity: Theory and Applications*. London Mathematical Society Lecture Note Series, Cambridge University Press, Cambridge.
8. Fung, YC 1965, *Foundations of Solid Mechanics*. Prentice Hall, Englewood Cliffs.

9. Germain, P 1973, *Cours de mécanique des milieux continus*. Tome 1. Théorie générale Masson et Cie, Editeurs, Paris. (in French)
10. Gurtin, ME 1981, *An Introduction to Continuum Mechanics*. Academic Press, New York.
11. Hahn, HG 1985, *Elastizitätstheorie*. B.G.Teubner, Stuttgart. (in German)
12. Holzapfel, GA 2000, *Nonlinear Solid Mechanics: A Continuum Approach for Engineering*. Birkhauser, Zurich.
13. Iliushin, AA 1990, *Mechanics of Continuum*, Moscow University Publishing House, Moscow. (in Russian)
14. Johns, DJ 1965, *Thermal Stress Analysis*, Pergamon Press, Oxford.
15. Kobayashi, AS (ed) 1987, *Handbook on experimental mechanics*. Prentice-Hall, Englewood Cliffs, New Jersey.
16. Korotkina, MR 1988, *Elektromagnetoelasticity*, Moscow University Press, Moscow. (in Russian)
17. Love, AEH 1944, *The Mathematical Theory of Elasticity*. Dover Publications, New York.
18. Lurè, AI 1990, *Nonlinear Theory of Elasticity*. North-Holland Series in Applied Mathematics and Mechanics, North-Holland, Amsterdam.
19. Maugin, GA 1988, *Continuum Mechanics of Electromagnetic Solids*. North Holland, Amsterdam.
20. Müller, W 1959, *Theorie der elastischen Verformung*. Akademische Verlagsgesellschaft Geest & Portig K.-G., Leipzig. (in German)
21. Nowacki, W 1962, *Thermoelasticity*. Pergamon Press, Oxford.
22. Nowacki, W 1970, *Theory of Elasticity*. PWN, Warszawa. (in Polish, in Russian)
23. Podstrigach, JS & Povstenko, YZ 1985, *Introduction into mechanics of surface phenomena in solids*, Naukova Dumka, Kiev. (in Russian)
24. Prager, W 1961, *Introduction to Mechanics of Continua*. Ginn, Boston.
25. Ratner, LW 2003, *Non-Linear Theory of Elasticity and Optimal Design*. Elsevier, London.
26. Rushchitsky, JJ & Tsurpal, SI 1998, *Waves in Materials with the Microstructure*. S.P.Timoshenko Institute of Mechanics, Kiev. (in Ukrainian)
27. Savin, GN & Rushchitsky, JJ 1976, *Elements of Mechanics of Hereditary Media*. Vyscha Shkola, Kyiv. (in Ukrainian)
28. Sedov, LI 1970, *Mechanics of Continuum*, in 2 vols. Nauka, Moscow. (in Russian)
29. Slaughter, WS 2001, *Linearized Theory of Elasticity*. Birkhauser, Zurich.
30. Sneddon, IN & Berry, DS 1958, *The Classical Theory of Elasticity*, vol.VI, Flüggé Encyclopedia of Physics. Springer Verlag, Berlin.
31. Sokolnikoff, IS 1956, *Mathematical Theory of Elasticity*. McGraw Hill Book Co, New York.
32. Sommerfeld, A 1964, *Thermodynamics and Statistical Mechanics*. Academic Press, New York.
33. Spencer, AJM 1980, *Continuum Mechanics*. Longman, London.
34. Storakers, B & Larsson, P-L 1998, *Introduktion till finit elasticitetsteori*. Hallfasthetslára, KTH. (in Swedish)
35. Taber, LA 2004, *Nonlinear Theory of Elasticity: Applications in Biomechanics*. Birkhauser, Zurich.
36. Timoshenko, SP & Goodyear, JN 1970, *Theory of Elasticity*, 3rd edn. McGraw Hill, Tokyo.
37. Truesdell, C 1969, *Rational Thermodynamics*. McGraw-Hill Book Company, New York.
38. Truesdell, C 1972, *A First Course in Rational Continuum Mechanics*. The John Hopkins University, Baltimore.

Questions

- 2.1. Which more complicate combinations of mechanical properties of materials exist, occurring in the real practice and reflecting in the mechanical theories and do not mentioned in the lecture? Indicate the degree of development of such theories.
- 2.2. Is the property of viscoelasticity characteristic for materials only? By other words, it is possible to speak about the viscoelastic materials and the viscoelastic fluids?
- 2.3. Presence of which properties will need the attraction of thermodynamical considerations when the theoretical model being created?
- 2.4. Which property of a material causes the energy dissipation when the material being deformed?

Please click the advert

MÄLARDALEN UNIVERSITY
SWEDEN

WELCOME TO OUR WORLD OF TEACHING!
INNOVATION, FLAT HIERARCHIES AND OPEN-MINDED PROFESSORS

STUDY IN SWEDEN - HOME OF THE NOBEL PRIZE
CLOSE COLLABORATION WITH FUTURE EMPLOYERS SUCH AS ABB AND ERICSSON

TAKE THE FAST TRACK

GIVE YOUR CAREER A HEAD START AT MÄLARDALEN UNIVERSITY
www.mdh.se

SASHA SHAHBAZI
LEFT IRAN FOR A MASTERS IN PRODUCT AND PROCESS DEVELOPMENT AND LOTS OF INNEBANDY
HE'LL TELL YOU ALL ABOUT IT AND ANSWER YOUR QUESTIONS AT MDUSTUDENT.COM

Download free ebooks at bookboon.com

3 On waves. Basic wave phenomena

Wave equation. Sound waves. Kirchhoff, Poisson, D'Alembert formulas. Well-posedness by Hadamard. Helmholtz and Taylor instabilities. John statement. Basic characteristics of waves. Polarization of waves. Reflection and refraction of waves. Interference of waves. Diffraction of waves.

Let us start with the classical wave equation. It is a hyperbolic equation of the form

$$a^2 \left(\frac{\partial^2 u}{\partial x_1^2} + \frac{\partial^2 u}{\partial x_2^2} + \frac{\partial^2 u}{\partial x_3^2} \right) - \frac{\partial^2 u}{\partial t^2} \equiv a^2 \Delta u - \frac{\partial^2 u}{\partial t^2} = f(x_1, x_2, x_3, t). \quad (3.1)$$

Here the Cartesian coordinates $Ox_1x_2x_3$ are utilized, Δ is Laplace operator, $u(x_1, x_2, x_3, t)$ is an unknown function describing a wave motion in an isotropic medium, $f(x_1, x_2, x_3, t)$ is a known function.

Besides the isotropy property, a number of assumptions about the character of physical process are needed for the procedure of obtaining the wave equation (3.1).

It can be explained on **the simplest example of sound waves**.

In this case the function $u = p(x, y, z, t) - p_o$ describes deviation of the gas pressure from the static pressure p_o , a constant sound velocity in the given gas medium is $a = c = \text{const}$.

First, the assumption of this medium homogeneity is accepted. It is also assumed that the value of acoustic deviation (that is, the function u) is considerably less than the static pressure (this means not less than on two orders).

And one more assumption - an average free run of gas molecules must be considerably less than the characteristic linear scale of deviation.

Note 3.1. It is also presented in the theoretical description of a sound propagation process that infinitesimal changes of density are formed by the same displacements of gas molecules.

So, the sound wave is meant as the propagating in a space longitudinal oscillations of gas molecules. That is, they propagate in the direction, which is called the direction of wave propagation.

It should be noted that the frequency of oscillation of gas molecules defines the name of a wave.

Definition 3.1. If it is lower than 16Hz , then it is called the infrasound wave; in the frequency range $16\text{Hz} \div 20\text{KHz}$ the sound wave is propagated; in the frequency range $20\text{KHz} \div 1\text{GHz}$ the supersound (ultrasound) wave is propagated; if the frequency is more than 1GHz (up to 10^{13}Hz), then it is the hypersound wave.

Consider the Cauchy classical solution for equation (3.1). This problem consists in finding the solution of equation (3.1), when the boundary conditions

$$u(x, t = +0) = u_0(x); \quad \frac{\partial u}{\partial t}(x, t = +0) = u_1(x) \quad (3.2)$$

are given and $(x \equiv (x_1, x_2, x_3))$.

Definition 3.2. The classical solution of Cauchy problem (3.1),(3.2) is understood the function $u(x, t)$ from the given class of functions $u(x, t) \in \mathbb{C}^2(t > 0) \cap \mathbb{C}^1(t \geq 0)$ (twice continuously differentiable for all $t > 0$ and continuously differentiable for $t \geq 0$), which satisfies the equation (3.1) for $t > 0$ and satisfies initial conditions (4.2) for $t \rightarrow +0$, as well.

Also all right side terms of equations (3.1), (3.2) have to satisfy some conditions of space coordinates continuity.

Such a **theorem** is valid:

If the external action $f \in \mathbb{C}^2(t \geq 0)$, initial conditions $u_0 \in \mathbb{C}^3(\mathbb{R}^n)$, $u_1 \in \mathbb{C}^2(\mathbb{R}^n)$ in the case of a 3D-space ($x = \{x_1, x_2, x_3\}; n = 3$), 2D -space ($x = \{x_1, x_2\}; n = 2$) and 1D -motion ($x = \{x_1\}; n = 1$) the external action $f \in \mathbb{C}^1(t \geq 0)$ and initial conditions $u_0 \in \mathbb{C}^2(\mathbb{R}^1)$, $u_1 \in \mathbb{C}^1(\mathbb{R}^1)$ satisfy the written conditions, then the classical solution of Cauchy problem (3.1),(3.2) is unique and can be expressed by:

1. Kirchhoff formula for $n = 3$

$$u(x, t) = \frac{1}{4\pi a^3} \int_{U(x; at)} \frac{f\left(\xi, t - \left|\frac{x - \xi}{a}\right|\right)}{|x - \xi|} d\xi + \frac{1}{4\pi a^2 t} \int_{S(x; at)} u_1(\xi) dS + \frac{1}{4\pi a^3} \frac{\partial}{\partial t} \left\{ \frac{1}{t} \int_{S(x; at)} u_0(\xi) dS \right\}$$

2. Poisson formula for $n = 2$

$$u(x, t) = \frac{1}{2\pi a} \int_0^t \int_{U(x; a(t-\tau))} \frac{f(\xi, \tau) d\xi d\tau}{\sqrt{a^2(t-\tau)^2 - (x-\xi)^2}} +$$

$$+ \frac{1}{2\pi a} \int_{U(x; a(t-\tau))} \frac{u_1(\xi) d\xi}{\sqrt{a^2 t^2 - (x-\xi)^2}} + \frac{1}{2\pi a} \frac{\partial}{\partial t} \int_{U(x; a(t-\tau))} \frac{u_0(\xi) d\xi}{\sqrt{a^2 t^2 - (x-\xi)^2}}$$

3. D'Alembert formula for $n = 1$

$$u(x, t) = \frac{1}{2a} \int_0^t \int_{x-a(t-\tau)}^{x+a(t-\tau)} f(\xi, \tau) d\xi d\tau + \frac{1}{2a} \int_{x-at}^{x+at} u_1(\xi) d\xi + \frac{1}{2} [u_0(x+at) + u_0(x-at)].$$

Besides them, the solutions above depend continuously on the given in Cauchy problem functions $f(x, t)$, $u_0(x)$, $u_1(x)$ in the sense that if data of the problem are changed slightly

$$|f - \tilde{f}| \leq \varepsilon, |u_0 - \tilde{u}_0| \leq \varepsilon_0, |u_1 - \tilde{u}_1| \leq \varepsilon_1, (|\text{grad}(u_0 - \tilde{u}_0)| \leq \varepsilon'_0 \quad n = 2; 3),$$

then the corresponding to these data solutions $u(x, t)$ and $\tilde{u}(x, t)$ will satisfy over an arbitrary finite time interval $0 \leq t \leq T$ the following estimates

$$|u(x, t) - \tilde{u}(x, t)| \leq \frac{T^2}{2} \varepsilon + T \varepsilon_1 + \varepsilon_0 + aT \varepsilon'_0 \quad (n = 2; 3), \quad |u(x, t) - \tilde{u}(x, t)| \leq \frac{T^2}{2} \varepsilon + T \varepsilon_1 + \varepsilon_0 \quad (n = 1).$$

Note 3.2. So, the continuous dependence means, in fact, that the small change of problem data causes the small change of solution.

It seems to be appropriate to fix here the definition of well-posedness of a solution according to Hadamard.

Definition 3.3. If a solution of any problem of mathematical physics fulfills three conditions: 1. A solution exists in certain class of functions M. 2. A solution is unique in other class of functions M. 3. A solution depends continuously on the problem data, then the problem is called **the well-posed problem**, the solution is called **the well-posed according to Hadamard solution**, the set MM is called the class of **well-posedness**.

Please click the advert

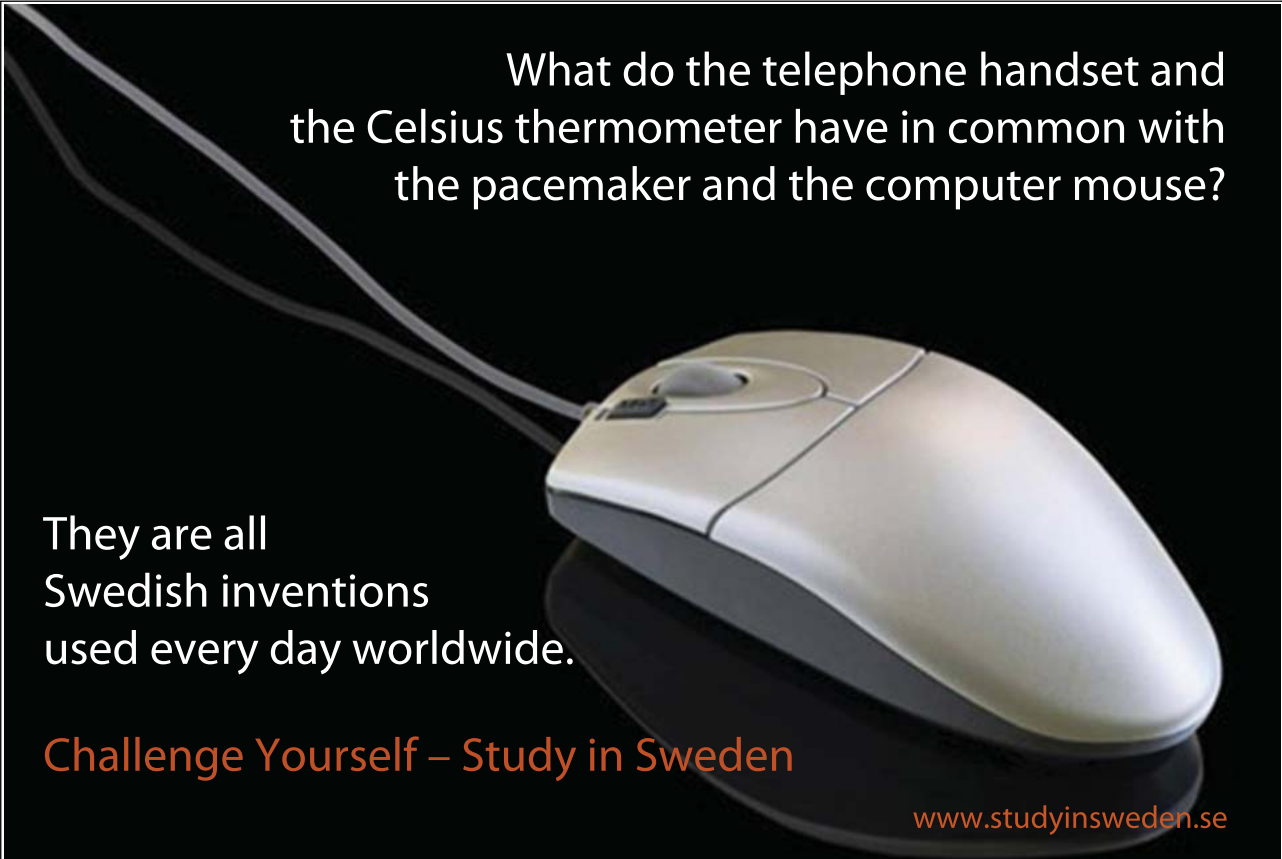

What do the telephone handset and
the Celsius thermometer have in common with
the pacemaker and the computer mouse?

They are all
Swedish inventions
used every day worldwide.

Challenge Yourself – Study in Sweden

www.studyinsweden.se

Requirements 1-3 look sufficiently natural, since they reflect the practical possibility of only approximate representation of all continuous depending parameters of the physical problem.

It is known as a rule in advance that the problem has a solution. In fact, well-posedness can be formulated with the aid of other words as the universality property of the method of solution finding, when this method saves its effectiveness even if by a small change of initially given parameters. Such a property may be also called the stability.

**Mathematical physics know a number of classical examples,
when well-posedness is braking (when the instability is displayed).**

Hadamard example

Let us consider Cauchy problem for Laplace equation

$$\Delta u \equiv \frac{\partial^2 u}{\partial x^2} + \frac{\partial^2 u}{\partial t^2} = 0 \quad (3.3)$$

$$u(x, 0) = 0, \quad u'(x, 0) = \frac{1}{k} \sin kx \quad (3.4)$$

The solution is as follows $u_k(x, t) = \frac{\sinh kt}{k^2} \sin kx$. The expression $\frac{1}{k} \sin kx$ in initial condition (3.4) tends to zero, when $k \rightarrow +\infty$ uniformly relative to x . But unfortunately in the case $x \neq m\pi$ ($m \in \mathbb{Z}$) the solution does not tend to zero

$$u_k(x, t) = \frac{\sinh kt}{k^2} \sin kx \not\rightarrow 0 \quad k \rightarrow +\infty$$

So, in the Cauchy problem (3.3),(3.4) a continuous dependence of the solution on initial conditions is not ensured. The problem, therefore, is not well-posed.

Helmholtz instability

The second classical example belongs to Helmholtz. It fixes a violation of the continuous dependence of a solution on problem data is the example about waves on the separation surface of gas and fluid.

The problem is considered as follows:

two semi-spaces are separated by a plane; in each of them the fluid (gas) flows uniformly; fluids (or gases, or gas and fluid) densities distinguish one from other; the flow in the neighbourhood of the separation surface is occurred with out the friction, that is, fluids or gases slide along the plane.

A number of assumptions on the character of a motion are accepted too (for example, absence of vortices).

As a result, the potential $\varphi^\alpha(x, y, z, t)$ of the motion velocity $\vec{v}^\alpha(x, y, z, t)$ fulfills the Laplace equation $\Delta\varphi^\alpha = 0$, where $\vec{v}^\alpha \equiv \{v_x^\alpha, v_y^\alpha, v_z^\alpha\}$; $\vec{v}^\alpha = \nabla\varphi^\alpha$; $\alpha = 1, 2$; superscripts 1 and 2 corresponds to upper and lower semi-space, respectively.

It is supposed also that mentioned slide plane is xOy plane, and three conditions have be fulfilled:

Condition 1. The velocity component $v_z^\alpha(x, y, z, t)$ is continuous by the transition through the slide plane, and further this plane is slightly disturbed and transformed into a surface (let us say, it becomes from plane to wavelike (sinusoidal) in the goffer form with a small amplitude); the component v_z^α has to be agreed with the normal component of the surface velocity $\partial z(x, y, t)/\partial t$.

Condition 2. Velocity of motion \vec{v}^α tends to $\left\{\pm\frac{1}{2}V, 0, 0\right\}$, when $x \rightarrow \pm\infty$ (V is the slide velocity).

Condition 3. Pressures p^α are continuous by transition through S and satisfy relations

$$p^\alpha - p_0 = -\rho^\alpha \left[\varphi_t^\alpha + \frac{1}{2}(\nabla\varphi^\alpha)^2 \right]$$

An analytical solution of the stated problem, which will describe negligible changes of flow near the disturbed (wavelike) slide surface, can be obtained. If the goffer length λ is given, and it is supposed the goffer amplitude is initially small and unknown function of time, then the solution permit to find this function. It depends exponentially on time and wave length λ in such a way that it increases infinitely when the length of goffer wave decreases. Such small λ can be found always for negligible small changed flow near S , for arbitrary given moment t_0 , and for arbitrary given number M , that the goffer amplitude at moment t_0 will increase in M times in comparison with an initial amplitude.

This increasing the amplitude of small disturbances of the separation surface is called **the Helmholtz instability**.

Note 3.3. In the real nature this instability is observed very often. **Just according to described mechanism the gentle breeze generates waves on the surface of initially calm reservoir.**

Taylor instability

The problem statement for this case is almost the same as in the prior case. The distinction will be in that the density of upper fluid have to be more than the one of lower fluid (that is, the upper is more heavy than the lower). It is also supposed that fluids do not move - they are in the calm. But in contrast to the Helmholtz statement, the gravity force is taken here into account. Just the gravity force and the distinction in densities form in this problem a new gravitational effect, which generates in its turn the solution similar to previous one. The increasing of the amplitude of small disturbances of the separation surface between fluids is observed anew.

This instability was called **the Taylor instability**.

Note 3.4. The Taylor instability is observed in the physical experiment, when in the upper part of vessel holds water, which is supported by a pressure of the air, which fills the lower part of vessel.

John statement

Let us pay attention to such a property of described instabilities: they are displayed in the appearance of waves.

In connection with them, one is possibly expediently to call to mind the seldom cited nontrivial

F. John sentence:

**the existence in the physical system of waves which propagate may be understood
as some form of instability of effects, which are more than their cause.**

Wave characteristics

Up to this point, all the wave analysis was based on using some wave characteristics, which were not accurately defined. Now the basic wave characteristics should be defined and discussed.

Let us remember that the wave is understood as the propagation in space of a disturbance of certain state of a physical or other system and consider now the attributes of the wave.



Please click the advert

Do you want your Dream Job?

More customers get their dream job by using RedStarResume than any other resume service.

RedStarResume can help you with your job application and CV.

Go to: Redstarresume.com
Use code "BOOKBOON" and save up to \$15

(enter the discount code in the "Discount Code Box")



So, the geometrical form (**the shape, the profile**) of disturbances can be diverse. Waves are distinguished by their form or, as it is said, by the kinematical attribute.

Note 3.5. This division highlights only the mostly used terms. However there are some waves out from this classification.

Besides **the form** or **the profile**, the wave is also characterized by **the velocity of propagation** and by **the phase**.

These notions are usually explained by means of the classical D'Alembert solution of wave equation (3.1). When some data are zero, then this solution may be found in the form

$$u(x,t) = f_1(ct - x) + f_2(ct + x). \quad (3.5)$$

Definition 3.4. Each of two summand in (3.5) is called **the running (travelling) wave**. The first one propagates in the positive direction, the second one in the opposite direction. Functions f_1 and f_2 give the form of a wave.

Definition 3.5. The quantity $\sigma = ct \pm x$ is usually called **the phase**, the quantity c is **the phase velocity** of a wave.

If running waves are periodical, then it is convenient to transform the solution (3.5) into the form

$$u(x,t) = f_1 \left[\frac{c}{\omega} (\omega t - kx) \right] + f_2 \left[\frac{c}{\omega} (\omega t + kx) \right]. \quad (3.6)$$

Here **the wave number** $k = (\omega/c) = (2\pi f/c) = (2\pi/\lambda)$ is introduced, **the wave length** λ and **the circular frequency** f are used.

Besides the solution in the form of running waves (3.6), the classical wave equation permits a solution in the form of **standing waves**. If the solution (3.6) is constructed by the variables separation method, then this solution will consist of sums of summands with the same structure

$$u_i(x,t) = X_i(x) \cdot T_i(t) = C_i \cos(k_i x + \varphi_x) \cos(\omega_i t + \varphi_t). \quad (3.7)$$

Quantities $C_i, \varphi_x, \varphi_t$ are constant, the first one is the amplitude, the second and the third ones are the phases.

Definition 3.6. Expression (3.7) describes an oscillation, which doesn't propagate, **it stands**. For this reason is called the standing wave.

From the existence theorem follows that there exists a correlation between the solutions of type (3.6) and (3.7). In fact, the standing wave may be obtained by the procedure of addition of two running waves, and the running wave may be obtained as the result of two standing waves beating. Therefore the solutions in the two forms - standing waves and running waves - are equivalent.

Let us discuss separately such characteristics of waves as **the wave polarization state**. For this purpose, the running harmonic waves are very available.

The harmonic wave is characterized by four attributes: 1. **The profile shape**, which it is always sinusoidal one. 2. **The amplitude**, which is constant and vector quantity. 3. **The wave vector**, which determines the direction of wave propagation. 4. **The frequency**.

Definition 3.7. The angle, which is formed by the amplitude vector and wave vector or, much more abstractly, the relationship between the amplitude and the phase characterize the state of wave polarization.

As an example, the plane displacement wave in a material can be considered. This wave will be discussed accurately in next lecture. Here the only one fact could be shown – in this case three independent directions of polarization are distinguished.

Definition 3.8. When oscillations of particles of a material, while the wave being propagated, occur along the wave propagation direction (that is, the mentioned above angle is equal to zero), then the wave is called **the longitudinally polarized one**.

Definition 3.9. When oscillations of particles of a material, while the wave being propagated, occur across the wave propagation direction (that is, the mentioned above angle is the right one), then the wave is called **the transversely polarized one**.

The vertically transversely polarized (corresponding to the vertical transverse oscillations of particles) and horizontally transversely polarized (corresponding to the horizontal transverse oscillations of particles) are distinguished.

Also, the electromagnetic plane wave has two independent directions of polarization and can be the transversely polarized. The polarization state influences essentially on interaction of waves (with other waves, with one-self, with other physical fields et cetera).

The polarization is observed not only for harmonic waves. This concerns to the waves with complicate profile, dispersive waves as well as non-periodic and solitary waves.

Four well-known wave phenomena accompanying in many cases the wave propagation.

The first one – **wave dispersion** – was already mentioned and will be discussed later too.

The second group of phenomena is named **the wave reflection and refraction**.

Physics accumulates a lot of observations of refraction, passing and reflection of the wave, when it meets on its propagation path some obstacle. In the case of materials, the easiest way to explain these phenomena on the simple problem on passing the plane wave through the boundary delimiting two different materials. In this problem the properties of both materials and the parameters of incident wave – amplitude, direction of propagation, polarization – are given. When the wave being met with the obstacle, the wave forms the reflected and refracted waves, to which all the energy of incident wave is transferred. The number of reflected and refracted waves depends on the wave parameters and the material properties.

Note 3.6. It can be always formulated the refraction law, according to which all the wave vectors are placed in the incident plane and the total sum of projections of all the wave vectors on the separation plane is equal zero.

Definition 3.10. The wave refraction means the passing the wave through the obstacle with changing the direction of incident wave.

Definition 3.11. The wave reflection means the change of wave propagation direction, but in this case the wave is propagated in the same material, from which it is arrived. For some conditions it is propagated in the opposite direction.

The phenomena of reflection and refraction have been studied in full for the sound waves.

Consider now the third wave phenomenon – **the wave interference**. It occurs in the case only, when two or more waves propagate in one and the same direction. Then they meet and mutually put together. Formed in this way superposition of waves can be constructive and destructive one. That is, the common wave motion in different points of a material can be intensified or relaxed.

Definition 3.12. For some points the arriving of wave crest is accompanied by the simultaneous arriving another wave crest. The set of such point forms the area of constructive interference or the area of interference maximum.

Definition 3.13. For other points the arriving of wave crest is accompanied by the simultaneous arriving another wave minimum. The set of such point forms the area of destructive interference or the area of interference minimum.

Please click the advert

Brain power

By 2020, wind could provide one-tenth of our planet's electricity needs. Already today, SKF's innovative know-how is crucial to running a large proportion of the world's wind turbines.

Up to 25 % of the generating costs relate to maintenance. These can be reduced dramatically thanks to our systems for on-line condition monitoring and automatic lubrication. We help make it more economical to create cleaner, cheaper energy out of thin air.

By sharing our experience, expertise, and creativity, industries can boost performance beyond expectations. Therefore we need the best employees who can meet this challenge!

The Power of Knowledge Engineering

Plug into The Power of Knowledge Engineering.
Visit us at www.skf.com/knowledge

SKF

Download free ebooks at bookboon.com

The cases, when the waves have identical frequencies and when these frequencies are distinguished, differ essentially. In the first case the difference between wave phases is constant and it is said then that waves are generated by **coherent sources**. The maximums and minimums are alternated and form so called **interference picture**. This picture is immovable despite of it is formed by the running waves. It seems to be unreasonable to describe the picture by words. Usually the picture is depicted in the form of photo or drawing.

Finally, the fourth phenomenon – **the wave diffraction** – should be discussed.

Definition 3.14. The diffraction of waves consists in that waves turn round the obstacles on the way of propagation.

The diffraction is characteristic for any wave process, when the obstacle size is not smaller than the wave length. This phenomenon is observed usually on single holes or openings as well as on systems of holes or openings.

Definition 3.15. If after passing the narrow opening the waves diverge, then it is said about the Fresnel diffraction.

Definition 3.16. If after passing the narrow opening the waves converge, then it is said about the Fraunhofer diffraction.

After passing the hole **the diffraction picture** is formed. In acoustics and optics, for example, the area after the obstacle is divided on three zones: 1. The shadow zone, where waves are absent. 2. The illumination zone, in which the incident wave propagate farther. 3. The intermediate between two first zones zone. These zones are observable very good.

Note 3.7. It is impossible owing to diffraction to form the bundle of plane waves with the given constant cross section. This cross section will increase with time.

Comments

Here is to the point to take notice of that existence of Kirchhoff, Poisson, D'Alembert formulas simplifies essentially the proof of a solution existence. Since presented by these formulas functions are solutions of the wave equation, what testifies by the substitution in (4.1), (4.2), then the solution exists. That is situation typical for physics, when existence of a solution is proven constructively - a solution is constructed and identified.

In the framework of pure mathematics, G. Cantor for the first time, then H. Poincare, and in the more distinct form D. Hilbert have been made more exact that the notion of existence is identical to a logical uncontradiction (**freedom of contradictions**). We see here two of principal distinct views on the notion of solution existence.

Next comment is associated with the polarization. Described in the lecture polarization, when the oscillations occur along the straight line, is classified as the linear polarization. In the case of circular polarization the transverse motion of particles (the motion in the plane perpendicular to the propagation direction is the circular one). If this motion occurs by the elliptic trajectories, then it is said about the elliptic polarization.

For creation the wave with given polarization, the different methods are utilized. The main physical device both the creation and the observation of polarized waves is the polaroid.

It seems to be interesting that some people are able to fix the polarization without the devices.

It should be noted that the interference phenomenon is the fundamental one in understanding the wave processes. It has been discovered in 1802 by T.Young. He has been used so called wave bath, which is utilized up this time for the demonstration of interference.

It is said about the near and far fields depending on the distance of the picture area from the sources generating the picture.

The incoherentness of sources complicates significantly the interference picture. First of all, the immovable for coherent sources interference bands becomes movable.

The last comment is associated with the diffraction picture. After passing the optic waves through the circular hole or turning round these waves the circular non-transparent screen, the so called diffraction rings in the form of dark and bright alternating rings are formed. Then the question arises: they are distinguished or not. The real distinction is absent.

But owing to historical causes the amplitude or intensity distribution for the finite number of coherent sources is named the interference picture. The same distribution of arranged continuously one after the other coherent sources is named the diffraction picture. It is said therefore about the interference picture for two narrow openings and the diffraction picture for one wide opening.

It should be noted also that the diffraction like many other wave phenomena has been studied for optic waves. A. Sommerfeld has been defined the diffraction as any deflection of light rays from the straight line, which can not be explained by reflection or refraction.

Because the theory of diffraction has for an object the determination of the perturbations in wave motion which propagate in the area beyond the obstacle, then the amplitudes, phases and polarizations of waves arising additionally in the wave picture should be determined. For this purpose different exact and approximate methods are used. Only three of them are exact ones. The first one is based on the Huygens-Fresnel principle and is named the sources method. The diffraction picture in the method is formed by superposition of secondary spherical waves which are radiate by each element. The second method is the traditional Fourier method. The third one uses the procedure of variable separation.

Further reading

1. Auld, BA 1973, *Acoustic Fields and Waves in Solids*, In 2 vol.. John Wiley, New York.
2. Birkhoff, G 1962, 'Helmholz and Taylor instability', *Proc. of Symposia in Appl. Math., Amer. Math. Soc.*, v.92, p.13.
3. Crawford, FS Jr 1968, *Waves*, Berkeley Physics Course, Vol.3. McGraw-Hill Book Company, New York.
4. Kobayashi, AS (ed) 1987, *Handbook on Experimental Mechanics*. Prentice-Hall, Englewood Cliffs, New Jersey.
5. Pohl, RW 1964, *Mechanik, Akustik und Wärmelehre*. Springer Verlag, Berlin. (In German)
6. Rose, JL 1999, *Ultrasonic Waves in Solid Media*, Cambridge University Press, Cambridge.

Questions

- 3.1. Can be defined analytically the wave without using the notion of wave phase?
- 3.2. Comment the standing wave from the point of view that the wave is one of kinds of motion.
- 3.3. Is the frequency the necessary element in theoretical description of waves?
- 3.4. Is the wave dispersion one of characteristics of a material or it is the convenient tool only in description of waves?
- 3.5. Get to know with the part of experimental mechanics of materials named “Photoelasticity” and show the link between this part and the phenomenon of wave interference.
- 3.6. The wave diffraction in materials is a quite studied part of mechanics of materials. Point out the types of waves most frequently discovered in this part of mechanics.

Trust and responsibility

NNE and Pharmaplan have joined forces to create NNE Pharmaplan, the world’s leading engineering and consultancy company focused entirely on the pharma and biotech industries.

Inés Aréizaga Esteva (Spain), 25 years old
Education: Chemical Engineer

– You have to be proactive and open-minded as a newcomer and make it clear to your colleagues what you are able to cope. The pharmaceutical field is new to me. But busy as they are, most of my colleagues find the time to teach me, and they also trust me. Even though it was a bit hard at first, I can feel over time that I am beginning to be taken seriously and that my contribution is appreciated.



NNE Pharmaplan is the world’s leading engineering and consultancy company focused entirely on the pharma and biotech industries. We employ more than 1500 people worldwide and offer global reach and local knowledge along with our all-encompassing list of services.

nnepharmaplan.com

nne pharmaplan®

Please click the advert

4 On waves. Harmonic waves

Basic characteristics of waves. Running waves. Harmonic waves. Wave dispersion. Phase and group wave velocities. Energy of waves. Wave energy velocity. Plane waves.

Let us dwell now on running harmonic waves, divided into **dispersive** and **nondispersive** ones. Usually for harmonic waves the dispersion relation $\omega = W(k)$ is given. In this case the phase velocity is defined as

$$v_{ph}(k) = W(k)/k \quad (4.1)$$

If the wave is formed by a few dispersive waves with closely spaced frequencies, then each of these waves will propagate with its own velocity. Such waves diverge in space (disperse), therefore the initial profile of the wave (composed of such waves) will change in time. The diffusion of an initially given profile of the wave packet is a characteristic attribute of the **dispersivity of waves**.

Let us focus on the basic properties of running waves. It is very convenient to study their basic characteristics on the one-dimensional harmonic waves. First of all, such a wave is represented mathematically with the simple formula

$$u(x, t) = A \cos \omega \left(t - \frac{x}{v_{ph}} \right). \quad (4.2)$$

The more habitual representation of the traveling harmonic wave has the form

$$u(x, t) = A \cos(\omega t - kx), \quad (4.3)$$

where $k = (\omega/v_{ph})$ is the **wave number**, which is linked with the **wave length** $\lambda = (2\pi/k)$. If the **period** $T = (1/f)$ and the **circular frequency** $f = (\omega/2\pi)$ are defined, then the **phase velocity** can be written as

$$v_{ph} = (\omega/k); \quad v_{ph} = \lambda f; \quad v_{ph} = (\lambda/T). \quad (4.4)$$

Note 4.1. The phase velocity defines the velocity of motion of the single crest, or the single valley, or the node on the wave profile.

Definition 4.1. Expression $\varphi(x, t) = \omega t - kx$ is called the **phase function** or the **phase**. It linearly depends on the independent variables x and t .

Note 4.2. When the phase value is fixed, then we focus at certain points on the wave profile. In fact, from the total differential for the fixed phase $d\varphi = \frac{\partial \varphi}{\partial t} dt + \frac{\partial \varphi}{\partial x} dx = \omega dt - k dx = 0$ follows that for the points of fixed phase $(dx/dt) = (\omega/k)$. These points move with the velocity v_{ph} , or, as it is often written, the observer, which moves with the velocity v_{ph} , sees all the time one and the same point of the wave profile. This explains why v_{ph} is called the phase velocity.

If to generalize slightly this approach and to suppose the wave to be quasi-harmonic, that is, to suppose its amplitude and phase be quietly change, then instead representation (4.3) the following one $u(x, t) = A(x, t)e^{i\varphi(x, t)}$ will be obtained. Instantaneous frequency and wave number are now defined by expressions

$$\omega(x, t) = \frac{\partial \varphi}{\partial t}; \quad k(x, t) = \frac{\partial \varphi}{\partial x}. \quad (4.5)$$

Obtained expressions can be expanded into Taylor series in the neighbourhood of certain point (x_0, t_0) , and by some conditions introduced instantaneous parameters will coincide with introduced above local parameters.

But by the same conditions, the medium is already dispersive for a wave and from the expression for the total differential (in supposing the equality $(\partial^2 \varphi / \partial x \partial t) = (\partial^2 \varphi / \partial t \partial x)$ is valid) the formula $\frac{\partial k}{\partial t} + \frac{\partial \omega}{\partial x} = 0$ or $\frac{\partial k}{\partial t} + \frac{\partial \omega}{\partial k} \frac{\partial k}{\partial x} = 0$ can be obtained. From the last formula follows that wave numbers are not changed by motion along the characteristics $(dx/dt) = \omega'(k)$.

Note 4.3. So, the observer who moves with the velocity $\omega'(k)$, will observe at any time a wave with the given wave number k .

Definition 4.2. The velocity $\omega'(k)$ is called the **group velocity**.

Besides traditional formula $v_g = \omega'(k)$, the Rayleigh formula $v_g = v_{ph} - \lambda v_{ph}'(\lambda)$ is often used.

Note 4.4. The name **group velocity** is explained by that this velocity arises, when the packet (group) waves in dispersive medium is considered. There, the group velocity is the velocity of this group of waves by the condition that the group preserves its form and dimensions.

One is need by outline that a group velocity can be treated as the velocity of disturbance of the wave number propagation, and it is constant for any given wave number. The definition and some formulas for a group velocity are complicated in the case of a wave motion in the anisotropic or nonone-dimensional medium. The notion of a group velocity for certain wave motions makes no sense, and is not used there. For example, for short pulses or pulses with the wide frequency spectrum.

One of the most important properties of waves consists in that they transport the energy and the pulse (motion capacity). For this reason, besides notions of the phase and group velocities the notion of velocity of energy propagation is sometimes utilized.

For understanding the problem, let us consider the classical wave equation in that form, which describes the longitudinal plane wave in an elastic body

$$\rho u_{tt}'' - (\lambda + 2\mu)u_{xx}'' = 0, \quad (4.6)$$

where u is the longitudinal displacement, ρ is the density, λ, μ are elastic constants.

Note 4.5. Wave equation (4.6) will be accurately introduced in next lectures when the elastic waves being explained.

With the initial conditions $u(x, 0) = f(x)$; $u'_t(x, 0) = 0$ the solution of equation (4.6) for waves in a positive direction is given by D'Alembert formula

$$u(x, t) = f(x - v_{ph}t), \quad (4.7)$$

where $x - v_{ph}t$ is the phase and the phase velocity $v_{ph} = \sqrt{((\lambda + 2\mu)/\rho)}$ is constant.

Definition 4.3. The total wave energy reached in the volume V is equal

$\mathcal{E} = \int_V EdV = \int_V (U + K)dV$, (kinetic and internal energies of the wave are given by formulas

$$K = \frac{1}{2}\rho(u'_t)^2, U = \frac{1}{2}(\lambda + 2\mu)(u'_x)^2).$$

Please click the advert

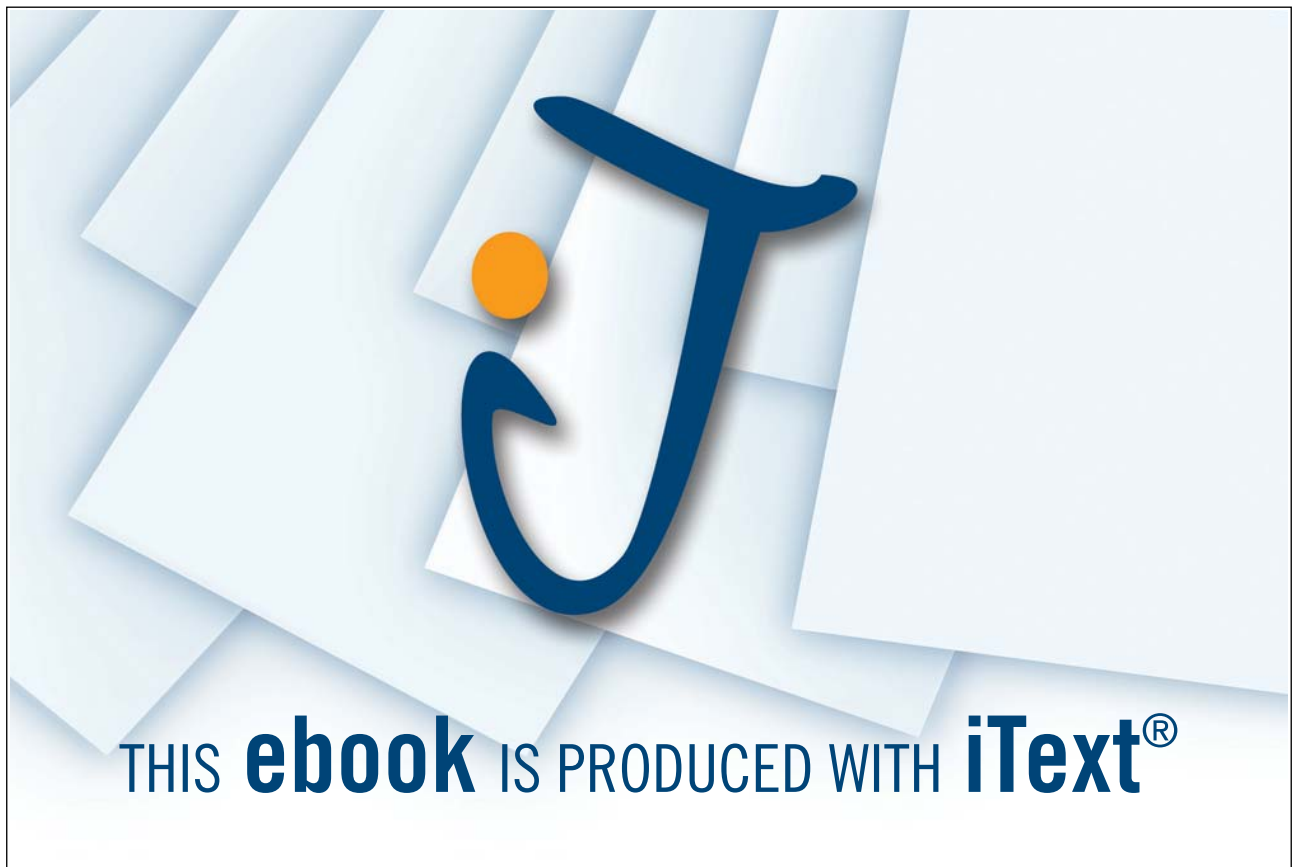

Let us calculate derivatives $\frac{\partial U}{\partial t} = (\lambda + 2\mu)u'_x u''_{xx}$, $\frac{\partial K}{\partial t} = \rho u'_t u''_{tt}$ and use Gauss-Ostrogradsky theorem $\int_V u'_x u''_{xx} dV = -\int_V u'_t u''_{xx} dV + \oint_S u'_t u'_x dS$. If now to take additionally into account the relations from Definition 4.3, then

$$\frac{d\tilde{E}}{dt} - \oint_S u'_t u'_x dS = 0. \quad (4.8)$$

Last equation is usually commented as follows:

**the change of the flux of a wave motion in the body V is equal
to the flux of energy through the surface S of the body.**

The integrand in (4.8) $P = u'_t u'_x$ defines the wave energy flux through the unit of a surface, and is the analog of Umov-Pointing vector, which is usually introduced for electromagnetic waves.

Definition 4.4. Velocity of the energy motion v_{en} is defined as a ratio of the flux energy density to the energy density $v_{en} = (P/E)$.

Since in this case

$$E = U + K = \frac{1}{2} [(\lambda + 2\mu) + \rho v_{ph}^2] (f')^2 = (\lambda + 2\mu) (f')^2, \quad P = (\lambda + 2\mu) v_{ph} (f')^2,$$

then

$$v_{en} = \frac{(\lambda + 2\mu) v_{ph} (f')^2}{(\lambda + 2\mu) (f')^2} = v_{ph}. \quad (4.9)$$

Note 4.5. Formula (4.9) expresses the classical result, according to which in the elastic medium, where waves propagate without the distortions, the phase velocity and velocity of the energy propagation are identical.

Somewhat other situation arises, when waves are propagated in the dispersive medium. First of all, the phase for dispersive harmonic waves has the form $\varphi = kx - \omega t$. Waves are periodical with the frequency ω and are described additionally by the wave number k . Also, quantities ω and k are coupled according to definition of dispersion by the condition $W'(k) \neq 0$. The phase velocity is not constant

$$v_{ph} = \frac{\omega}{k} = \frac{W(k)}{k} \neq const. \quad (4.10)$$

Representation (4.10) testifies the wave dispersion, which will be displayed in the distortion of an wave initial profile. Phase velocity loses its role of the basic characteristics of wave motion. The new characteristics appears – the group velocity of a wave $v_{gr}(k) = \frac{dW(k)}{dk}$.

The specificity of such wave energy propagation study is convenient to observe on the Klein-Gordon wave equation

$$\rho\varphi''_{tt} - \alpha^2\varphi''_{xx} \pm \beta^2\varphi = 0,$$

which is classical in the theory of dispersive waves. This equation has the solution in the form of harmonic waves

$$\varphi(x,t) = Ae^{i(kx-\omega t)}.$$

It is easy to see that the dispersion relationship has the form $\omega = \pm\sqrt{\alpha^2k^2 \pm \beta^2}$, and the phase and group velocities are expressed by formulas

$$v_{ph}(k) = \frac{\pm\sqrt{\alpha^2k^2 \pm \beta^2}}{k}; v_g(k) = \frac{\alpha^2k}{\pm\sqrt{\alpha^2k^2 \pm \beta^2}}.$$

Note 4.6. Let us fix that in the dispersive waves theory one useful relationship also exists. It couples the phase and group velocities, and for given equation it has the form

$$v_{ph}(k) \cdot v_g(k) = \alpha^2 = const.$$

Let us find internal and kinetic energies of the wave

$$U = \frac{1}{2}[\alpha^2(\varphi'_x)^2 \pm \beta^2\varphi^2], K = \frac{1}{2}\rho(\varphi'_t)^2,$$

calculate derivatives $\frac{\partial U}{\partial t}, \frac{\partial K}{\partial t}$, and construct the Umov-Pointing equation. Also, choose, as it is usually done, the monochromatic wave of the form $\varphi(x,t) = \varphi_0 \cos(kx - \omega t) \equiv \varphi_0 \cos z$ and evaluate the velocity of energy propagation of this wave. For one thing, it is need to find

$$P = -\alpha^2k\omega\varphi_0^2 \sin^2 z;$$

$$K = \frac{1}{2}[\rho\omega^2\varphi_0^2 \sin^2 z + \alpha^2k^2\varphi_0^2 \sin^2 z \pm \beta^2 \cos^2 z].$$

Now the expression for the velocity of wave energy propagation can be written according to Definition 4.4

$$v_{en} \neq v_{ph}, v_{en} \neq v_g. \quad (4.11)$$

Expressions (4.11) suit nobody, because all three basic velocities become not identical. Then there are said that we will not interest in details of oscillations of waves. And therefore, expressions for P and K can be averaged over the period of oscillations. Since averaged values of $\sin^2 z$ and $\cos^2 z$ are equal to $1/2$, then

$$v_{en} = \frac{P_{mean}}{E_{mean}} = \frac{\alpha^2}{v_{ph}} = v_g. \tag{4.12}$$

For averaged energy, the equality (4.12) - the equality of the group velocity and the velocity of energy propagation - has the general character.

The last part of this chapter-lecture is devoted to the plane waves. Two reasons are for this special attention. First, among all the wave types, the plane waves are the most studied. Second, all next chapters will include the discussion and considerations just plane waves as applied to different models of materials.

So, let us choose some direction defined by the unit vector \vec{n}^o and assume that the plane wave is defined as the D'Alembert wave propagating in the direction \vec{n}^o with constant phase velocity v_{ph} and amplitude \vec{u}^o

$$\vec{u}(x, t) = \vec{u}^o f \left[t - \left(\xi / v_{ph} \right) \right], \tag{4.13}$$

where denotations are adopted $\xi = \vec{n}^o \cdot \vec{r} = n_1^o x_1 + n_2^o x_2 + n_3^o x_3$, $\vec{n}^o = \{n_k^o \equiv \cos \alpha_k^o\}$, $\vec{r} = \{x_1, x_2, x_3\}$.

Please click the advert

The Milkround System
LAUNCHING GRADUATE CAREERS

MILKROUND SYSTEM
 Become a business star with internships, placements, graduate jobs & schemes from leading companies.
www.milkround.com

PLANET CAREER ADVICE
 Inhabited by insights into business careers and orbited by application advice.

FIRST CONTACT
 Get matched to top business employers via intelligent emails landing in your inbox.

Milkround.com: rated the #1 graduate recruitment website in the UK Graduate Careers Survey 2009 of 16,000 university finalists.

Milkround.com

At any time the function $\vec{u}(x, t)$ will be constant in the plane defined by the equation

$$\xi = \vec{n}^o \cdot \vec{r} = n_1^o x_1 + n_2^o x_2 + n_3^o x_3 = \text{const}.$$

Let the wave move during the time interval Δt , then the vector \vec{r} will change on the value $\Delta \vec{r}$.

If at that time the argument of function $\vec{u}(x, t)$ will be invariable, then the function will be also invariable. But this means that the direction \vec{k} is just the direction in which the wave is moving.

On the other hand, the relationship between quantities Δt and $\Delta \vec{r}$ is as follows

$$\vec{k} \vec{r} - \omega t = \vec{k} (\vec{r} + \Delta \vec{r}) - \omega (t + \Delta t) = \text{const} \text{ or } \vec{k} \Delta \vec{r} = \omega \Delta t.$$

The last formula can be considered as the equation of the above plane, but shifted congruently in space on the distance $|\Delta \vec{r}|$. That is, this plane moves in the direction of the wave vector \vec{k} .

In terms of wave analysis, the harmonic wave (4.13) has the front in the form of some plane and this front moves in direction \vec{k} .

This is why the wave is called the plane wave.

The phase velocity for plane waves is introduced standardly as $v_{ph} = (\omega/k)$. The group velocity is defined as the vector $\vec{v}_{gr} = (\partial \omega / \partial \vec{k})$ or $\vec{v}_{gr} = \{\partial \omega / \partial k_i\}$.

In isotropic materials the dispersion is identical in all the directions and then $\vec{v}_{gr} = \vec{k}^o (\partial \omega / \partial k)$. That is, the group of waves (signal) propagates in direction of the wave vector, which is identical for all the waves from the group.

In anisotropic materials, the wave vector is convenient to write in spherical coordinates (r, φ, ϑ) and then to write the expression for the group velocity

$$\vec{v}_{gr} = \frac{\partial \omega}{\partial \vec{k}} = \vec{k}_r \left(v_{ph} + k \frac{\partial v_{ph}}{\partial k} \right) + \vec{k}_\varphi \frac{\partial v_{ph}}{\partial \varphi} + \vec{k}_\vartheta \frac{1}{\sin \vartheta} \frac{\partial v_{ph}}{\partial \vartheta}.$$

Here the first coordinate reflects the effect of dispersion on the group velocity and two other reflects the effect of anisotropy.

Also from last formula the Rayleigh formula follows $\vec{k}_r \vec{v}_{gr} = v_{ph} - k \frac{\partial v_{ph}}{\partial k} = v_{ph} - \lambda v_{ph}'(\lambda)$.

It is convenient to stress finally that the plane wave is characterized by four parameters:

- 1) **The arbitrary form of the profile described by twice continuously differentiable function f .**
- 2) **The arbitrary amplitude \vec{u}^o .**
- 3) **The fixed polarization (direction of the vector \vec{u}^o) of this amplitude.**
- 4) **The fixed phase velocity v_{ph} .**

In order to find the unknown phase velocity and amplitude polarization, we must substitute (4.18) into the equation of motion for the concrete model of material.

Comments

Let us start with the fact that theory of waves is essentially better than it can be presented in the short lecture notes. The situation is like to the well-known sentence about the Wagner music:

it is essentially more better when is written comparing with when it is hearing.

The subject of next comment is the running wave. It should be noticed that running waves are some abstraction, since they are understood as waves propagating in the infinite space. Sometimes such a medium, which doesn't have a boundary, is called **the open medium**. The terms "running", "traveling" are often used, but it is also used the term "progressive", which is equivalent to the initially used in German classic physics term "die fortschreitende Welle".

The third comment is associated with that in the problem of energy propagation by means of waves, the history of physics was fixed some **primary special case**. In the Maxwell electromagnetic theory, the energy of medium has the volume density $\frac{1}{8\pi}(\epsilon E^2 + \mu H^2)$, depending, as it is seen from this representation, on squares of electric field intensity E and electrical field induction H . Waves transport energy, and, according to Maxwell, the falling on a surface electromagnetic wave causes the pressure on this surface, which is equal to volume density of the wave.

This statement contemporary to Maxwell physicists have been assumed to be wrong.

Afterwards, P.N. Lebedev has been conducted experiments on a light pressure, and has been proved that the Maxwell convictions were true. The first physicist consequently studying the energy transporting by waves was N.A. Umov (in that time associate professor at Odessa University), which has been submitted 1874 PhD thesis "Equations of the energy motion in bodies". Later 1885 J.H. Pointing was been published the next by significance work on energy of electromagnetic waves. Umov and Pointing are considered the founders of wave energy discovering. The basic notion in the energy transporting theory is the Umov-Pointing vector.

The fourth comment is related to dispersion. An introducing the dispersive waves becomes very fruitful, because **the first attribute** $W'(k) \neq 0$ does not restrict a basic equation (wave propagation equation) by only partial differential equations. But this dependence is restricted by **the second attribute** - the wave have to be necessary harmonic one. Therefore, **the third attribute**, according to which these waves are called, the possibility to description of physical phenomenon of wave dispersion, that is, the blur phenomenon of a wave profile for propagating waves is transformed into attribute (5.12) and is explained as follows:

particles in different points of a wave profile move with different velocities and therefore after some time this profile is deformed.

Such understanding the dispersion needs some next comments.

In reality, linear free harmonic wave with the given frequency is not deformed at all.

Consider the wave profile, which is formed from a few linear harmonic waves with closed frequencies. Just such a profile will be deformed owing to dispersivity of formed its waves of the harmonic form.

Please click the advert

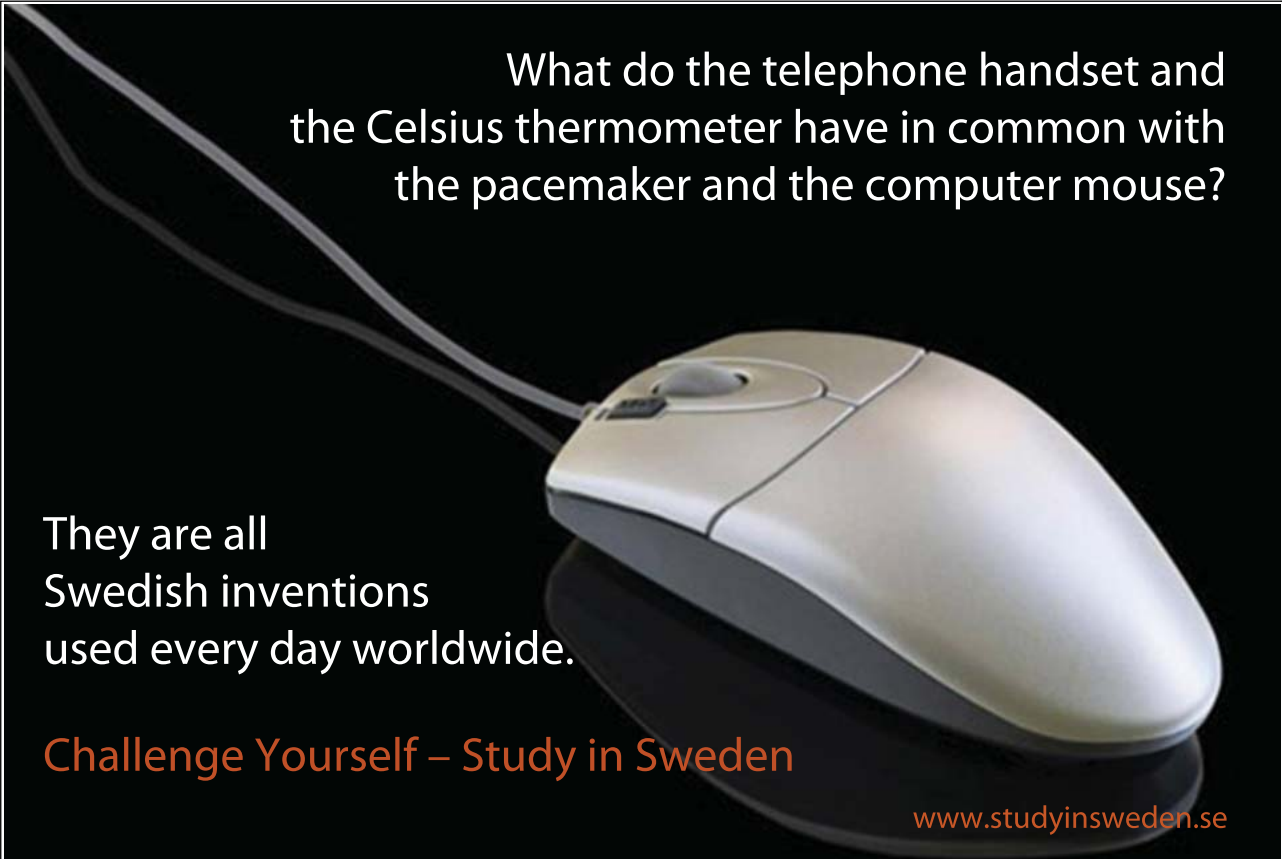

What do the telephone handset and the Celsius thermometer have in common with the pacemaker and the computer mouse?

They are all Swedish inventions used every day worldwide.

Challenge Yourself – Study in Sweden

www.studyinsweden.se

Download free ebooks at bookboon.com

Further reading

1. Achenbach, JD 1973, *Waves Propagation in Elastic Solids*. North-Holland, Amsterdam.
2. Brekhovskikh, LM & Goncharov, VV 1982, *Introduction to Mechanics of Continuum (In Application to Wave Theory)*, Nauka, Moscow. (In Russian)
3. Chen, PJ 1972, *Wave motion in solids*, Flugge's Handbuch der Physik, Band VIa / 3, Truesdell, C (ed), Springer Verlag, Berlin.
4. Dieulesaint, E & Royer, D 1974, *Ondes elastiques dans les solides. Application au traitement du signal*. Masson et C'ie, Paris. (In French)
5. Graff, KF 1975, *Wave Motion in Elastic Solids*. Ohio State University, Columbus.
6. Hudson, JA 1980, *The Excitation and Propagation of Elastic Waves*. Cambridge University Press, Cambridge.
7. Levine, AH 1978, *Unidirectional Wave Motions*. North-Holland, Amsterdam.
8. Rose, JL 1999, *Ultrasonic Waves in Solid Media*. Cambridge University Press, Cambridge.
9. Tolstoy, I 1973, *Wave Propagation*. McGraw Hill, New York.

Questions

- 4.1. Write the analytical attribute of harmonic wave dispersion. In which way the link (adequateness) of this attribute and the physical definition of dispersion can be established?
- 4.2. Dispersion is divided on geometrical, viscoelastic and structural ones. Which main distinctions between each two of three can be pointed?
- 4.3. Which physical types of harmonic waves can be pointed using the attribute of frequency range or the wave length?
- 4.4. In the chapter, the problem of energy propagation is considered for elastic materials only. Will be the energy of wave motion and the velocity of energy propagation respectively depend on other physical properties of the material, in which the waves propagate?
- 4.5. In which way the causes of distinction with each other of phase velocity, the group velocity and the velocity of energy propagation in materials displaying the wave dispersion can be commented?
- 4.6. Indicate the differing from the plane wave types of waves by the attribute of the wave front shape.
- 4.7. Is the distortion of wave profile the effect of dispersion or other causes of such a change can be pointed?

5 Elastic volume and shear waves

Basic linear elastic model. Kinematics and kinetics of motion. Displacement, strain, stress. Balance equations. Elastic wave equations. Volume and shear elastic waves.

In the chapter the basic statements of the theory of elasticity are explained. This theory is the part of continuum mechanics, where the real material (there are known on which, that it is deformed pure elastically and do not display other basic physical properties) is modeled by the elastic continuum.

It is assumed that the reader is familiar with the theory of elasticity, and the first part of the chapter is intended to refresh in memory the most important notions of the theory, which will be necessary to understand the regularities of wave propagation in elastic materials. The linear models will be considered only and the effect of nonlinearity on wave propagation will not be discussed.

So, the continuum while being applied to the materials, is equipped by two types of fields – kinematic and kinetic fields.

Definition 5.1. The field is understood here as some function, given at each point of the continuum, quite smooth usually and having certain physical sense.

The elastic continuum is equipped by two kinematic fields –

the vector field of displacements $\vec{u}(x_1, x_2, x_3) \equiv \{u_i(x_1, x_2, x_3)\}$ ($i = 1, 2, 3$)

the tensor field of strains $\varepsilon(x_1, x_2, x_3) \equiv \{\varepsilon_{ik}(x_1, x_2, x_3)\}$ ($i, k = 1, 2, 3$) –

and two kinetic fields –

the scalar field of mass density $\rho(x_1, x_2, x_3)$

the tensor field of stresses $\sigma(x_1, x_2, x_3) \equiv \{\sigma_{ik}(x_1, x_2, x_3)\}$ ($i, k = 1, 2, 3$).

When the continuum being moved (the material being deformed), then two states are distinguished: the initial (undeformed) state corresponding to the initial moment and the actual (deformed) state corresponding to the actual moment.

Note 5.1. In description of continuum kinematics the geometrical only notions are used and the knowledge of physical properties is not necessary. This means that the kinematic description of materials will not depend on the basic properties of materials and for all the models of materials this description will be identical.

Definition 5.2. The displacement in the point (particle) of continuum is defined as the distance in three-dimensional Euclidean space between the point (particle) in the initial state and the point in the actual state, to which is translated the particle after motion of continuum (after deformation of material). It is convenient to represent the displacement in the form of vector with three coordinates.

Definition 5.3. The linear strain tensor is defined basing on the displacement vector

$$\varepsilon_{ik} = \frac{1}{2} \left(\frac{\partial u_i}{\partial x_k} + \frac{\partial u_k}{\partial x_i} \right) = \frac{1}{2} (u_{i,k} + u_{k,i}). \quad (5.1)$$

Note 5.2. The mass as the physical notion is always positive and therefore as the mathematical notion can be assumed as the measure. It is usually supposed that the mass do not change when the continuum being moved from the initial state to the actual one.

The stress tensor is introduced in the essentially more complicate way. If to assume that the strain tensors highlight the geometric side of the deformation process, then the stress tensors represent other side of the process, which is linked with the primary in mechanics notions of **the force** and **the moment**.

The forces are parted on external and internal ones.

Please click the advert



Sharp Minds - Bright Ideas!

Employees at FOSS Analytical A/S are living proof of the company value - First - using new inventions to make dedicated solutions for our customers. With sharp minds and cross functional teamwork, we constantly strive to develop new unique products - Would you like to join our team?

FOSS works diligently with innovation and development as basis for its growth. It is reflected in the fact that more than 200 of the 1200 employees in FOSS work with Research & Development in Scandinavia and USA. Engineers at FOSS work in production, development and marketing, within a wide range of different fields, i.e. Chemistry, Electronics, Mechanics, Software, Optics, Microbiology, Chemometrics.

We offer
A challenging job in an international and innovative company that is leading in its field. You will get the opportunity to work with the most advanced technology together with highly skilled colleagues.

Read more about FOSS at www.foss.dk - or go directly to our student site www.foss.dk/sharpminds where you can learn more about your possibilities of working together with us on projects, your thesis etc.

Dedicated Analytical Solutions

FOSS
 Slangerupgade 69
 3400 Hillerød
 Tel. +45 70103370
www.foss.dk

The Family owned FOSS group is the world leader as supplier of dedicated, high-tech analytical solutions which measure and control the quality and production of agricultural, food, pharmaceutical and chemical products. Main activities are initiated from Denmark, Sweden and USA with headquarters domiciled in Hillerød, DK. The products are marketed globally by 23 sales companies and an extensive net of distributors. In line with the corevalue to be 'First', the company intends to expand its market position.



Download free ebooks at bookboon.com

The internal forces act within the body and are described by the internal stresses. Stresses (the word **internal** is as a rule omitted) are treated in mechanics as the primary notion. The stresses are an abstraction, too. They are a convenient tool, but not absolutely necessary.

Note 5.3. The waves of stresses are therefore in some sense the abstraction.

Considering such introductory words as very useful, we shall go on to the notion of the stress tensor.

There are many ways of an introducing of this tensor. Here one of them will be described consistently.

So, let us choose the arbitrary volume V and assume, that action of the rest of the body on the V can be substituted by the action of some vector field of forces, which is given on the external surface S of body V .

Note 5.4. This procedure constitutes an essence of the **Euler-Cauchy principle of cutting**.

Now, it is necessary to remember, that for the surface the infinitesimal element $dS(x)$ is one piece of the tangential plane to S at the point x . The vector of a force acting on the infinitesimal element of surface dS , is denoted by $d\vec{P}$ and assumed to be equal

$$d\vec{P}(x) = \vec{t}_N dS(x). \quad (5.2)$$

Here, \vec{t}_N is the stress vector, which is applied to the surface dS with the normal \vec{N} .

Note 5.5. It should be noted that vector \vec{t}_N will depend not only on the position x and possible on time, but on the orientation \vec{N} of the surface. Also, it should be drawn the attention that two hypotheses are in fact supposed:
1. Internal forces are forces of a local contact interaction. 2. The vector field is specified at each point of the surface and depends both on this point and on the normal to the surface at this point.

In such a way introduced notion of the stress vector is now at a distance of one step from the notion of the stress tensor.

It is considered usually that if the vector \vec{t}_N will decompose on components in three orthogonal directions linked with dS (i.e. on **tangente**, **normal**, and **binormal**), then this vector generates three stresses. The values of stresses can be considered as the values of obtained vectors, related to the surface element dS (divided on the area of surface element dS).

Note 5.6. Just therefore, the stresses can be briefly characterized as the force related to the area.

Further, the way of introducing the internal stress tensor is usually as follows. The infinitesimal coordinate tetrahedron is introduced and it is supposed to be in the balance by the action of forces (5.2) applied to the tetrahedron faces.

Here two possibilities exist and both are realized:

the elementary tetrahedron can be chosen in the undeformed state or the deformed state. In each case, tetrahedrons are curvilinear and they go from one to other.

Note 5.7. The simple formula can be written which links the element area of the tetrahedron face in undeformed state with the same element in a deformed state. The main conclusion from an analysis of the tetrahedron balance is apparently the conclusion that the quantities of nine stresses on the three coordinate faces form the tensor of the second rank. We shall remember that according to the definition such a tensor is transformed by some law when the coordinates being transformed affine. When the tetrahedron is fixed, the stress tensor is invariant to the choice of a reference system.

Definition 5.4. The nine quantities $t^{nm}(x_k, t)$, which are called the stresses, form the stress tensor.

It involves stresses at moment t on the surfaces of an elementary volume in the deformed state, which are measured on the unit area in the initial state (i.e., in the undeformed state).

Definition 5.5. This tensor is called the **Piola-Kirchhoff stress tensor**, it is asymmetric, and it does not immediately determine the stress state in a body.

The **Lagrange-Cauchy stress tensor** $\sigma^{ik}(X^\alpha, t)$ is introduced in much the same way. It involves the stresses, which are measured on the unit area in the actual configuration (i.e., in the deformed state). This tensor is symmetric.

The shown above tensors are most used. But also other stress tensors: **Piola tensor, Hamel tensor, the second Piola-Kirchhoff tensor, tensor of generalized stresses, tensor of true stresses** and others are used.

Next part of the chapter is devoted to the balance equations. The initial point of view is the well-known sentence that

the great laws of classic physics can be considered as one general law of conservation.

So, the general approach in the formulation of such laws exists and will be described further.

Consider some extensive tensor quantity $\mathbf{A}(x, t)$, which characterizes somehow the material continuum. This can be mass, temperature, pulse (momentum), moment of momentum, energy. Let us give in addition three quantities linked with \mathbf{A} :

1. $\mathcal{A}(x, t)$ - the volume density of quantity \mathbf{A}

$$\mathbf{A} = \int_{V(t)} \mathcal{A} dV \quad (V(t) \text{ is a closed connected domain}).$$

2. $A(x, t)$ - the increment of volume density $\mathcal{A}(x, t)$ induced by the influx from without, for example, owing to the sources placed inside the domain $V(t)$.
3. $\alpha(x, t, \vec{n})$ - the rate of flux density of quantity \mathbf{A} through the boundary of the domain $V(t)$; here, \vec{n} is the normal to the surface $S(t)$.

Note 5.8. All three introduced quantities can be arbitrary tensor fields. But $\mathbf{A}(x, t)$ and $A(x, t)$ are always the fields of the same dimension, whereas $\alpha(x, t, \vec{n})$ is the field with the dimension on the one more.

The conservation law expresses such a balance (equilibrium) - the change of the quantity \mathbf{A} over unit of time results:
1. presence of the flux of this quantity through the boundary surface; 2. work of sources (discharges) within the body.

By the formula, this law is expressed in such a way

$$\frac{d}{dt} \int_{V(t)} \mathbf{A} dV = \int_{V(t)} \mathbf{A} dV - \int_{S(t)} \alpha dS. \quad (5.3)$$

Note 5.9. In mechanics, two different operation of the differentiation of tensors are used. The first characterizes the rate of changing of the tensor field at the fixed geometrical point (place), for it the symbol $\partial/\partial t$ is used and it is called **the local derivative**. The second characterizes the same rate at the fixed material point (particle), for it the symbol d/dt is used and it is called **the material (substantial) derivative**.

Please click the advert

The Wake

the only emission we want to leave behind

Low-speed Engines Medium-speed Engines Turbochargers Propellers Propulsion Packages PrimeServ

The design of eco-friendly marine power and propulsion solutions is crucial for MAN Diesel & Turbo. Power competencies are offered with the world's largest engine programme – having outputs spanning from 450 to 87,220 kW per engine. Get up front! Find out more at www.mandieselturbo.com

Engineering the Future – since 1758.

MAN Diesel & Turbo



If \mathbf{A} is the vector quantity and quantities A , α are the smooth functions, then balance equations are written in the differential form

$$\frac{\partial}{\partial t} \wedge_k + (\wedge_k v_m + \alpha_{km})_{,m} = A_k,$$

where $\vec{v} \equiv \dot{\vec{u}} = \{v_m \equiv \dot{u}_m\}$ is the vector of particle velocity (velocity at the material point).

The conservation laws give the most of equations needed in the mechanics of materials. One of the first such equations is the equation for continuity, which follows from the law of mass balance.

So, let \mathbf{A} is the mass. Further, we shall use instead of $\mathbf{A}(x, t)$ the adopted in physics symbol for the volume density of mass $\rho(x, t)$. If to suppose that the interchange of material between parts of a body is absent, i.e., the sources and discharges of mass are absent in a body ($A(x, t) = 0$) and the flux of mass through the boundary surface is absent ($S(\alpha(x, t, \vec{n})) = 0$), then from equation (5.3) the classic equation of the mass balance follows

$$\frac{d}{dt} \int_V \rho(x, t) dV = 0 \quad \left(\frac{\partial \rho}{\partial t} + (\rho v_m)_{,m} = 0, \quad \frac{\partial \rho}{\partial t} + \text{div}(\rho v) = 0 \right).$$

When the condition of sufficient smoothness of the quantities: $\rho(x, t)$ - the density at the moment t , $\rho_o(x, t)$ - the density at the initial moment; $J(x, t)$ - the Jacobian of the transformation - are adopted, then $\rho_o = \rho J$.

The next important balance relation highlights the second Newton law. The balance of momentum is considered. Let us remember that the law assumed the knowledge of external forces. The quantity \mathbf{A} is as follows

$$\mathbf{A}(x, t) = \int_V \rho v(x, t) dV, \text{ and } \wedge(x, t) = \rho v_i(x, t).$$

Then two other quantities $A(x, t)$, $\alpha(x, t, \vec{n})$ will express accordingly the external forces and the stress tensor

$$A_i(x, t) = F_i(x, t), \quad \alpha_i(x, t, n_k) = -\sigma_{ik}(x, t) n_k.$$

The law of conservation of a moment can be now written in the following form

$$\frac{d}{dt} \int_V \rho(\xi) v_i(\xi, t) dV(\xi) - \int_S \sigma_{ik}(\xi, t) n_k dS(\xi) = \int_V F_i(\xi, t) dV(\xi).$$

As a rule, all integrands are supposed to be continuously differentiable, further the Gauss-Ostro-gradsky theorem is applied to the surface integral and the formula is written in the local (differential) form and with the Euler coordinates

$$\frac{\partial}{\partial t}(\rho v_i) + (\rho v_i v_k)_{,k} = \sigma_{ik,k} + F_i$$

or after some transformations by taking of the mass balance equation into account in the more usual form of three motion equations

$$\rho(dv_i/dt) = \sigma_{ik,k} + F_i. \quad (5.4)$$

The third balance equation is concerned with the moment of momentum and has the form

$$\frac{d}{dt} \int_V \rho(\xi) \epsilon_{ilm} \xi_l v_i(\xi, t) dV(\xi) - \int_S \sigma_{ik}(\xi, t) \epsilon_{ilm} n_k dS(\xi) = \int_V \epsilon_{ilm} \xi_l F_i(\xi, t) dV(\xi).$$

Here, external moments are supposed to be formed only by the action of external forces and by ϵ_{ilm} is denoted the Levi-Civita symbol.

Note 5.10. The usual corollary fact of basic equations (5.4) for assumed conditions is that **the stress tensor is symmetric.**

The fourth group of balance relations consists of equations of the energy balance.

Definition 5.6. The energy of body \mathcal{E} is defined as the sum of kinetic energy of body \mathcal{K} and of internal energy of body \mathcal{U} .

In the bottom, the balance equation of energy is the first principle of thermodynamics:

the full derivative of energy of body E at arbitrary moment is equal to the sum of the power P of external forces acting on a body and the heat quantity Q acquired of a body during unit time.

Therefore, a definition of the power is very important. It is assumed usually that the power of external forces (volume forces $\vec{F} = \{F_i\}$ and surface forces $\vec{S} = \{S_i\}$) is defined by the formula

$$\mathcal{P} = \int_V F_i(\xi, t) v_i(\xi, t) dV(\xi) + \int_{\Sigma} S_i(\xi, t) v_i(\xi, t) d\Sigma(\xi).$$

If to assume surface forces are absent (this assumption is adopted in the prior three groups of balance equations) and that the effect of heat is neglected (this assumption is adopted in the classic theory of elastic deformations), then the representation of the first principle of thermodynamics will be as follows

$$\begin{aligned} \frac{d}{dt} \mathcal{E} = \mathcal{P} \quad \text{or} \quad \frac{d}{dt} \int_V \rho(\xi, t) \left(\frac{1}{2} v_i(\xi, t) v_i(\xi, t) + e \right) dV(\xi) = \\ = \int_{\Sigma} \sigma_{ik}(\xi, t) n_k(\xi) v_i(\xi, t) d\Sigma(\xi) + \int_V F_i(\xi, t) v_i(\xi, t) dV(\xi). \end{aligned} \tag{5.5}$$

Here, the **specific internal energy** is denoted by e .

Equation (5.5) is the balance energy equation of elastic body and corresponds adequately to the general structure of balance equations, since

$$A = \rho(\xi, t) \left(\frac{1}{2} v_i(\xi, t) v_i(\xi, t) + e \right), \quad A = F_i(\xi, t) v_i(\xi, t), \quad \alpha = \sigma_{ik}(\xi, t) n_k(\xi) v_i(\xi, t).$$

Please click the advert

Technical training on *WHAT* you need, *WHEN* you need it

At IDC Technologies we can tailor our technical and engineering training workshops to suit your needs. We have extensive experience in training technical and engineering staff and have trained people in organisations such as General Motors, Shell, Siemens, BHP and Honeywell to name a few.

Our onsite training is cost effective, convenient and completely customisable to the technical and engineering areas you want covered. Our workshops are all comprehensive hands-on learning experiences with ample time given to practical sessions and demonstrations. We communicate well to ensure that workshop content and timing match the knowledge, skills, and abilities of the participants.

We run onsite training all year round and hold the workshops on your premises or a venue of your choice for your convenience.

For a no obligation proposal, contact us today at training@idc-online.com or visit our website for more information: www.idc-online.com/onsite/

Phone: **+61 8 9321 1702**
 Email: training@idc-online.com
 Website: www.idc-online.com



Further, the necessity arises to write more concrete the internal energy for an elastic body.

Note 5.11. Most often the continua are studied, for which the internal energy exists in the form of an **elastic potential** (or a **function of stored energy**). This is the kind of so called **hyperelastic bodies** or **hyperelastic materials**.

The **elastic potential** can be introduced both with the aim of the Green strain tensor $W(\varepsilon_{nm}, x^k)$, and with the aim of the gradient of displacements $W(u_{,j}^i, x^k)$. It can be proven that differential of the function W is the total one for the stationary and non-stationary processes. Then the stress tensors t^{nm} and σ^{ik} can be evaluated according to the procedure

$$t_{nm} = \frac{\partial W(u_{i,j}, x_k)}{\partial u_{m,n}}, \quad \sigma_{nm} = \frac{\partial W(\varepsilon_{ij}, x_k)}{\partial \varepsilon_{nm}}. \quad (5.6)$$

So, three equations (5.4) can be supplemented by six constitutive equations (5.6), which link the stress and strain tensor components. The standard form of linear constitutive equations is as follows

$$\sigma_{ik} = C_{iklm} \varepsilon_{lm}, \quad (5.7)$$

where the four rank tensor C_{iklm} represents the set of elastic constants for anisotropic materials.

Equations (5.4) and (5.7) together with linear formulas (5.1) give the basic system of equations for waves in the classical structural linear approach (that means, within the framework of linear theory of elasticity). It has the form of three coupled partial differential equations of the second order relative to three components of the displacement vector $u_k(x_1, x_2, x_3, t)$

$$C_{iklm} (\partial^2 u_m / \partial x_k \partial x_l) + X_i = \rho (\partial^2 u / \partial t^2). \quad (5.8)$$

This system corresponds to the general case of anisotropy of elastic materials. Classical analysis of volume and shear waves is conventionally carried out for the case of isotropic materials. Because in this case the tensor of elastic properties can be written as follows

$$C_{iklm} = \lambda \delta_{ik} \delta_{lm} + \mu (\delta_{il} \delta_{km} + \delta_{im} \delta_{kl}), \quad (5.9)$$

the initial system becomes simpler and takes the form of classical Lamé equations

$$(\lambda + \mu) \text{graddiv} \bar{u} + \mu \Delta \bar{u} = \rho (\partial^2 u / \partial t^2). \quad (5.10)$$

The way of splitting of motion equation (5.10) on two different wave equations is used in theory of elasticity. The basic step consists in that an arbitrary vector \bar{u} can be always represented as the sum of a potential and a solenoidal vector (Helmholtz theorem) $\bar{u} = \bar{v} + \bar{w}$ ($\text{rot} \bar{v} = 0, \text{div} \bar{w} = 0$).

Note 5.12. If vector \vec{u} represents the displacements (in elasticity), then vector \vec{v} characterizes only the deformations accompanying the volume change because of $\text{rot } \vec{v} = 0$, whereas vector \vec{w} characterises only the deformations, accompanying the form change because of $\text{div } \vec{u} = 0$.

Usually the first vector \vec{v} is written through **a scalar potential**, which is defined with exactness to an arbitrary function of time $\vec{v} = \text{grad } \varphi$. The second vector \vec{w} is written through **a vector potential**, which is defined with exactness to an arbitrary vector field $\vec{w} = \text{rot } \vec{\psi}$.

Therefore being applied to (5.10) the operator div gives the wave equation relative to \vec{v}

$$\left[\Delta - (\rho/(\lambda + 2\mu))(\partial^2/\partial t^2) \right] \vec{v} = 0,$$

as well as the application of operation rot gives the wave equation relative to \vec{w}

$$\left[\Delta - (\rho/\mu)(\partial^2/\partial t^2) \right] \vec{w} = 0.$$

Both last equations are the classical wave equations. The first one describes the volume waves of deformations with the constant phase velocity $v_{ph} = \sqrt{\rho/(\lambda + 2\mu)}$, whereas the second one describes the shear waves of deformation with the constant phase velocity $v_{ph} = \sqrt{\rho/\mu}$. The corresponding potentials $\varphi, \vec{\psi}$ fulfill also the same wave equations.

Comments

Let us start with the Bertrand Russell sentence that

the humanity is making mistakes every case when supposed the one parts of its is better than other parts.

The similar situation can be noted with separation of the theory of elasticity on theoretical and applied parts. Therefore despite of the modern practicalness, we recommend to draw your attention on the theoretical part of the theory of elasticity, too.

Next comment is associated with the classical definition of a force:

the quantity defining qualitatively the action of bodies one on other, which cause an acceleration, is called the force.

The first comment to stresses is that the notions of force and moment are some physical abstraction, which is intended for the description of action of the body on the body or particles of the body on the particles of the body.

The second comment to stresses that the intuitive knowledge exists about forces in mechanics:

any applied to the body force has the point of applying, the direction and the intensity.

It is convenient therefore to represent the external forces by the vector field and by the distribution of this field. If such a distribution is the mass distribution in a body, then forces are called the mass forces. If the measure of a distribution is the surface measure, then forces are called the surface forces. In the same way, the notions of the linear forces and the point forces are introduced.

It should be noted that the mentioned above volume and shear waves are the free waves, that is, the waves propagating in the infinite elastic space.

In practice, these waves are, for example, the waves propagating in the earth's crust for the cases of earthquake and are recorded by seismic stations. From comparison of phase velocities follows that the volume waves are arriving at the station before the shear ones.

Further reading

1. Atkin, RJ & Fox, N 1980, *An Introduction to the Theory of Elasticity*, Longman, London.
2. Dagdale, DS & Ruiz, C 1971, *Elasticity for Engineers*, McGraw Hill, London.
3. Graff, KF 1975, *Wave Motion in Elastic Solids*, Ohio State University, Columbus.
4. Germain, P 1973, *Cours de mécanique des milieux continus*. Tome 1. Théorie générale. Masson et Cie, Editeurs, Paris. (In French)
5. Gurtin, ME 1981, *An Introduction to Continuum Mechanics*, Academic Press, New York.
6. Hahn, HG 1985, *Elastizitätstheorie*, B.G.Teubner, Stuttgart. (in German)
7. Love, AEH 1944, *The Mathematical Theory of Elasticity*, Dover Publications, New York.
8. Lurè, AI 1990, *Theory of Elasticity*, North-Holland Series in Applied Mathematics and Mechanics, North-Holland, Amsterdam.
9. Miklowitz, J 1966, *Elastic Wave Propagation*, Applied Mechanics Reviews, Spartan Books.
10. Nowacki, W 1970, *Theory of Elasticity*, PWN, Warszawa. (In Polish)
11. Tolstoy, I 1973, *Wave Propagation*, McGraw Hill, New York.

Questions

- 5.1. The nonlinear theory of elasticity is discovering the finite deformations and distinguishes the initial and actual shape of the body, the linear theory of elasticity is discovering the infinitesimal deformations and do not distinguish the initial and actual shape of the body. Respectively, different strain tensors (Cauchy-Green, Almansi, logarithmic, Hencky-Green, Hencky-Almansi, Finger et cetera) are used in the nonlinear theory, whereas one only strain tensor is used in the linear theory. Will be the nonlinear tensors, while being transformed to the linear approach, come to one and the same representation?
- 5.2. The similar question relative to the used in the nonlinear theory stress tensors (Kirchhoff, Lagrange, Piola, true stresses, generalized stresses et cetera).
- 5.3. In which cases the mass balance equation is necessary to use? Are discovered the waves in media with the variable mass?
- 5.4. Which structural properties of the material define the level of its anisotropy?
- 5.5. It is observed the property of isotropic material to separate the wave motion on volume and shear waves, when the transition to less symmetric by the property structure materials is done (for example, to transversely isotropic materials)?

6 Elastic linear harmonic plane waves

Basic linear model. Plane linear harmonic elastic waves. Christoffel equations. Christoffel tensor. Types of plane waves and corresponding wave equations. Refraction and reflection of plane harmonic elastic waves. Five conditions of the contact

At the beginning, let us write anew the linear motion equations of the theory of elasticity (written for the arbitrary case of anisotropy of elastic properties and in terms of displacements)

$$C_{iklm} u_{m,ik} - \rho \ddot{u}_i = 0. \quad (6.1)$$

Then by substituting the representation of the plane wave from chapter-lecture 5

$$\vec{u}(x,t) = \vec{u}^o f \left[t - \left(\xi / v_{ph} \right) \right], \quad (6.2)$$

into (6.1) and introducing the Christoffel tensor $\Gamma_{ik} = C_{ijkl} k_j k_l$ we get the Christoffel equation for plane waves in linear elastic materials

$$\Gamma_{ik} u_k^o = \rho (v^{ph})^2 u_i^o. \quad (6.3)$$

Please click the advert

I joined MITAS because
I wanted **real responsibility**

The Graduate Programme
for Engineers and Geoscientists
[Maersk.com/Mitas](https://www.maersk.com/mitas)



Month 16
I was a construction
supervisor in
the North Sea
advising and
helping foremen
solve problems

Real work
International opportunities
Three work placements





Download free ebooks at bookboon.com

From three Christoffel equations (6.3) follows that the components of vector \vec{u}^o , which define the wave polarization, are the tensor Γ_{ik} eigenvectors and the corresponding eigenvalues are $\rho(v^{ph})^2$ and they define the phase velocity of polarized wave. Thus, the Christoffel procedure reduces the problem of determination of plane wave parameters to the mathematical eigenvalue problem for the tensor Γ_{ik} .

Because the tensor of elastic properties C_{ijkl} is symmetric, then also the Christoffel tensor Γ_{ik} is symmetric. Hence its eigenvalues are real quantities and eigenvectors are orthogonal. The density ρ is the positive quantity and the eigenvalues are always positive quantities. There follows that the phase velocities of plane waves are real quantities and the waves really propagate.

Let us comment more in detail three classical types of symmetry of materials – orthotropic, transversally isotropic, and isotropic – as applied to plane wave propagation.

Note 6.1. This classification is used most frequently when the engineering materials being studied. It is associated probably more with possibilities of that time theoretical analysis than with the real properties of materials. Just for these three types of property symmetry the methods of analysis in the theory of elasticity are developed.

The simplest case is the isotropic medium. It is defined as the medium in which the properties are invariant relative any orthogonal transforms.

The Christoffel tensor for an isotropic medium is as follows

$$\Gamma_{ik} = (\lambda + \mu)k_i^o k_k^o + \mu\delta_{ik} \quad (6.4)$$

and the Christoffel equation for an isotropic medium is written as

$$(\lambda + \mu)(\vec{k}^o \cdot \vec{u}^o)\vec{k}^o = (\rho v_{ph}^2 - \mu)\vec{u}^o. \quad (6.5)$$

Equation (6.5) admits two variants of polarization.

The first variant agrees with collinearity of wave and displacement vectors. This corresponds to the longitudinal wave with the constant phase velocity $v_{ph} = \sqrt{(\lambda + 2\mu)/\rho}$.

The second variant defines an infinite number of directions, what follows from orthogonality of wave and displacement vectors. This corresponds to the transverse wave with the constant phase velocity $v_{ph} = \sqrt{\mu/\rho}$. Thus the choice of certain direction of plane wave propagation doesn't have any influence on the wave characteristics: number of waves (two only), the phase velocity, and the mutual polarization.

Consider now the case of transversal isotropic properties of the propagation medium. Such a medium has one axis of symmetry (so called the main axis, later the applicate axis is chosen) and all the planes perpendicular to this axis are isotropic from the point of view of elastic properties (at any point of this plane the properties are identical).

$$\left\{ \begin{array}{cccccc} C_{1111} & C_{1122} & C_{1133} & 0 & 0 & 0 \\ & C_{1111} & C_{1133} & 0 & 0 & 0 \\ & & C_{3333} & 0 & 0 & 0 \\ & & & C_{4444} & 0 & 0 \\ & & & & C_{4444} & 0 \\ & & & & & \frac{1}{2}(C_{1111} - C_{1122}) \end{array} \right\}$$

The matrix of elastic constants C_{ijkl} includes five independent constants as it is shown in the matrix of elastic constants above.

Orthotropic materials are symmetric by elastic properties relative to three mutually orthogonal axes. The number of independent elastic constants is equal to nine. The matrix of elastic constants is shown right.

$$\left\{ \begin{array}{cccccc} C_{1111} & C_{1122} & C_{1133} & 0 & 0 & 0 \\ & C_{2222} & C_{1133} & 0 & 0 & 0 \\ & & C_{3333} & 0 & 0 & 0 \\ & & & C_{2323} & 0 & 0 \\ & & & & C_{3131} & 0 \\ & & & & & C_{1212} \end{array} \right\}$$

Let us return to the transversally isotropic materials.

When the waves propagate along the symmetry axis, then two variants of polarization and two variants of the wave types are possible respectively: **the longitudinal wave with the phase velocity $v_{ph} = \sqrt{(C_{3333}/\rho)}$ and the transverse wave in the plane of isotropy with polarization along the abscissa axis and the phase velocity $v_{ph} = \sqrt{(C_{1313}/\rho)}$.**

When the waves propagate perpendicular to the symmetry axis, then three types of polarization are possible: **the longitudinal wave with polarization in the direction of abscissa axis and with the phase velocity $v_{ph} = \sqrt{(C_{1111}/\rho)}$, the transverse wave with polarization in direction of the symmetry axis and the phase velocity $v_{ph} = \sqrt{(C_{4444}/\rho)}$; the transverse wave with polarization in the direction of ordinate axis and the phase velocity $v_{ph} = \sqrt{((1/2)(C_{1111} - C_{2211}))/\rho}$.**

In orthotropic materials, three polarized waves will propagate along each of three symmetry axes – longitudinal, transverse horizontally polarized and transverse vertically polarized ones. Some of them will have identical phase velocities like to the case of the transversally-isotropic materials.

The next usual step in studying the plane waves in isotropic materials is to assume that the direction of propagation coincides with the abscissa axis so that

$$\vec{u} = \{u_k(x_1, t)\}. \quad (6.6)$$

Substitution of representation (6.6) into basic system (6.1) gives three linear wave equations

$$\rho \ddot{u}_1 - (\lambda + 2\mu)u_{1,11} = 0, \quad \rho \ddot{u}_2 - \mu u_{2,11} = 0, \quad \rho \ddot{u}_3 - \mu u_{3,11} = 0. \quad (6.7)$$

Note 6.2. Equations (6.7) describe one longitudinal plane wave (P -wave) and two transverse plane waves - horizontal polarized wave (SH -wave) and vertical polarized wave (SV -wave), respectively.

The corresponding solutions in the form of harmonic waves are

$$u_1(x_1, t) = u_1^o e^{i(k_L x_1 - \omega t)}, \quad k_L = (\omega/v_L), \quad v_L = \sqrt{(\lambda + 2\mu)/\rho},$$

$$u_2(x_1, t) = u_2^o e^{i(k_T x_1 - \omega t)}, \quad u_3(x_1, t) = u_3^o e^{i(k_T x_1 - \omega t)}, \quad k_T = (\omega/v_T), \quad v_T = \sqrt{\mu/\rho}.$$

Please click the advert

The advertisement features a grid of four images. The top-left image shows a person in a white shirt working at a computer workstation with a green chair. The top-right image shows two women in professional attire, one in a pink shirt and one in a white turtleneck, engaged in a conversation. The bottom-left image shows a man in a dark suit holding a folder or document. The bottom-right image shows a modern, multi-story building with illuminated windows at night. A large, stylized blue wave graphic curves across the bottom of the collage.

www.job.oticon.dk

oticon
PEOPLE FIRST

Thus the harmonic plane waves propagate in the linearly elastic isotropic medium with constant velocity and are the simplest nondispersive waves.

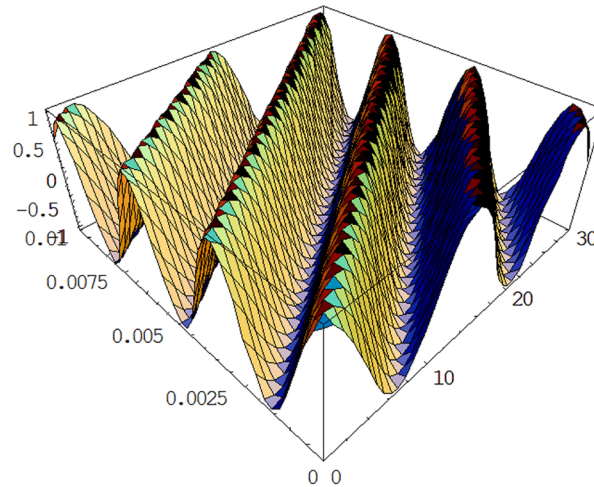

Fig. 6.1. Dependence of wave amplitude on space coordinate and time.

Let us show four standard pictures for elastic harmonic plane waves: three-dimensional wave picture “wave amplitude – space coordinate – time” (Fig.6.1) and three two-dimensional plots “amplitude – space coordinate” (with fixed time moment), “phase velocity – frequency” and “wave number –frequency” (last two are so called dispersion curves in the general case; in this simplest case they will be the straight lines).

All pictures are shown for the elastic longitudinal plane wave propagating with frequency $\omega = 100 \text{ kHz}$ in steel with properties $\rho = 7.8 \cdot 10^3 \text{ kg/m}^3$, $\lambda = 94 \text{ MPa}$, $\mu = 79 \text{ MPa}$. The phase velocity and wave number are Fig. 6.1. Dependence of wave amplitude on as follows $k_L = (\omega/v_L) = 17.6 \text{ m}$;

space coordinate and time. $v_L = \sqrt{(\lambda + 2\mu)/\rho} = 5.68 \text{ km/s}$,

Then the wave phase is $z = kx_1 - \omega t = 17.6x_1 - 100,000t$,

when the distance is measured in meters and time in seconds.

The Figs. 6.1 and 6.2 shows the wave picture according to the formula

$$u(x_1, t) = u^o \cos(17.6x_1 - 100,000t),$$

where the initial wave amplitude u^o is assumed to be small $u^o = 1 \cdot 10^{-4} \text{ m}$ and corresponds on the pictures to unit.

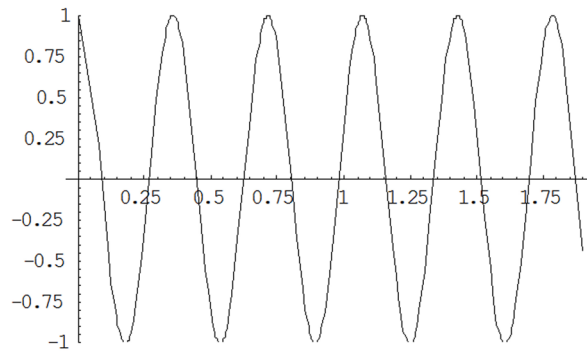

Fig.6.2. Dependence of wave amplitude on space coordinate

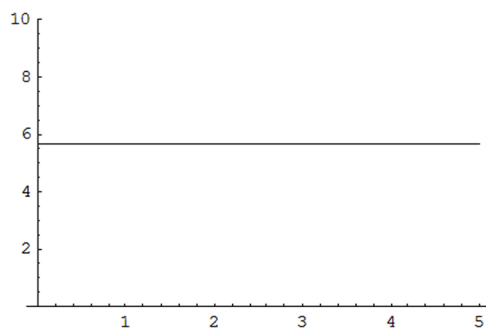

Fig.6.3. Dependence of phase velocity on frequency

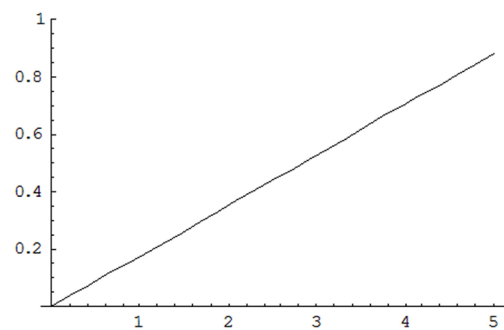

Fig.6.4. Dependence of wave number on frequency

The Fig. 6.3 and 6.4 correspond to arbitrary frequency and show two straight lines

$$v_{ph} = v_{ph}(\omega) = 5.68, \quad k = 0.176\omega.$$

Thus, the plane elastic harmonic waves display the simplest wave behaviour: **the sinusoidal profile is not distorted with propagation, the wave is nondispersive – the phase velocity is constant and do not depend on frequency, the wave number depends linearly on frequency.**

Consider now another way of introduction of the wave equation into mechanics of materials. The simplest mechanical object for studying the waves is **a rod**.

Definition 6.1. The rod is meant as the three-dimensional body, the length of which in one dimension is essentially more than in two other dimensions. The most often rods have the cylindrical form with the circular or rectangular cross sections. In this case the sizes of the rod cross-section must be smaller than the rod length and it is said therefore that the rod is thin one.

Assume the rod as having the constant circular cross-section and the rod lateral surface being free of stresses. **Consider now the elementary theory of waves in such a rod.**

Note 6.3. The simplest forms of loading the rods are five ones: tension, compression, torsion, pure bending, transverse bending.

It is assumed in this theory that each cross-section rests the plane one after deformation and the stresses in the cross-section are distributed uniformly. All the assumptions above restrict the analysis of waves in rods to the waves the wave length of which exceed significantly the rod diameter.

Let the rod axis is directed along the abscissa axis, the rod is compressed or tensed initially and then the rod is left by itself. Then the longitudinal oscillations along the axis will arise. The oscillations will displace the cross-sections.

Let x is abscissa of some cross-section at the initial moment. Denote by $u(x, t)$ the displacement of cross-section at moment t . Then the corresponding strain in the longitudinal direction at moment t will be $\frac{\partial u(x, t)}{\partial x}$. If denote the corresponding stress in longitudinal direction at moment t as $\sigma(x, t)$, then the Hooke law in this simplest one-dimensional state tension-compression is as follows $\sigma(x, t) = E \frac{\partial u(x, t)}{\partial x}$, where E is Young modulus of the rod.

Please click the advert

What do the telephone handset and
the Celsius thermometer have in common with
the pacemaker and the computer mouse?

They are all
Swedish inventions
used every day worldwide.

Challenge Yourself – Study in Sweden

www.studyinsweden.se

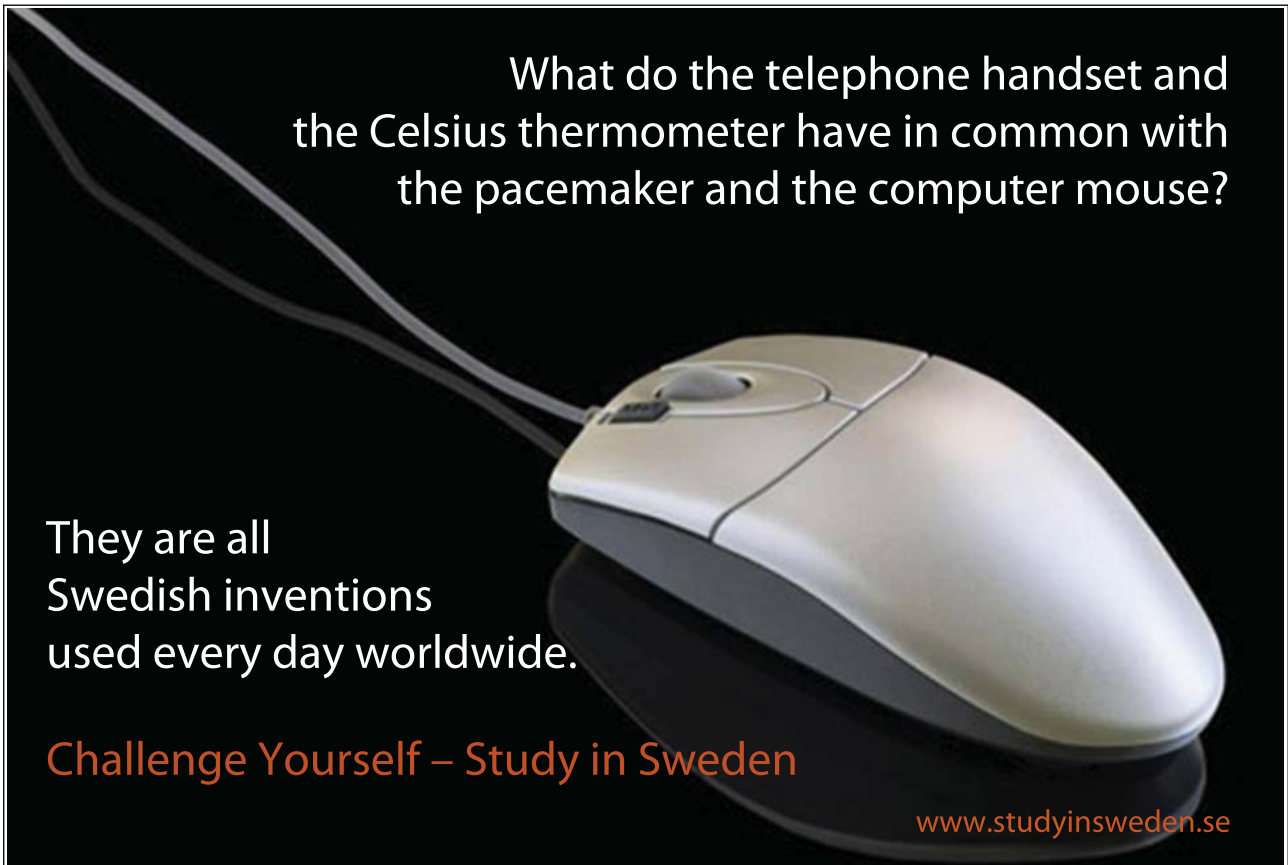

Now the impulse balance equation (or the Newton second law) can be used in the form

$$\rho \frac{\partial^2 u(x,t)}{\partial t^2} = \frac{\partial \sigma(x,t)}{\partial x} \rightarrow \rho \frac{\partial^2 u(x,t)}{\partial t^2} = E \frac{\partial^2 u(x,t)}{\partial x^2}, \text{ where } \rho \text{ is the rod density.}$$

Denote $a = \sqrt{E/\rho}$. Then the last equation can be written in the form of the classical wave equation

$$\frac{\partial^2 u(x,t)}{\partial t^2} - a^2 \frac{\partial^2 u(x,t)}{\partial x^2} = 0. \quad (6.8)$$

The equation (6.8) is called in the classical mathematical physics the equation of longitudinal waves (oscillations) in the homogeneous rod. In mechanics, this equation corresponds to the elementary theory of waves in rods.

Consider now the phenomena of refraction and reflection of plane harmonic waves. The proposed description will have the general character for materials and will not depend on properties contained in the model. But the explanation is restricted as a formality to the elastic model.

The linear model for elastic and homogeneous materials does not describe the interaction of waves. The volume (longitudinal) and shear (transverse) free waves propagate uncoupled.

But when in the medium the surface (boundary, interface) exists, which separates the medium on two parts with different properties, then the situation is changed significantly. Being arrived on the interface, the waves perform three actions: they reflect from the interface, pass through the interface, and generate new waves.

Let us consider these phenomena on simple examples.

The standard simple problem is the problem on interaction of plane waves on the plane boundary of two semi-spaces. Three components must be presented in this problem: the plane boundary, the elastic semi-spaces, the plane harmonic wave (the direction of propagation, polarization and amplitude).

In the general case, the wave arriving from the first medium to interface generates in threes waves from each side of interface. Three waves – one longitudinal and two transverse – reflect from the interface and propagate further in the first medium. In the second medium, three similar waves propagate.

Definition 6.2. These last waves are called the refracted waves.

Note 6.4. In anisotropic media the six waves mentioned above can be quasi-longitudinal and quasi-transverse ones. In the case of both isotropic media all the waves will be longitudinal and transverse; from each side two waves will propagate.

So, in the problem in hand three types of waves are figured:

1. **The incident on the interface waves** (will be denoted by index I). 2. **The reflected from the interface waves** (will be denoted by index R). 3. **The passing through the interface waves, which propagate-travel further** (will be denoted by index T).

Now the problem to write on the boundary one or another condition of mechanical contact arises.

Below five different sets of the most often used conditions are shown.

Conditions 1. The conditions of full mechanical contact of two elastic semi-spaces.

They mean the equilibrium on the interface (let it will be the plane $x_3 = 0$) of displacements and stresses

$$\vec{u}^{(1)}(x_1, x_2, 0, t) = \vec{u}^{(2)}(x_1, x_2, 0, t), \quad \sigma_{3i}^{(1)}(x_1, x_2, 0, t) = \sigma_{3i}^{(2)}(x_1, x_2, 0, t). \quad (6.9)$$

The conditions (6.9) are the universal ones for the theory of elastic continua. It seems to be more logical in the theory of elastic waves to write these conditions picking out the displacements and stresses, which are generated by the each wave separately. That is, the next conditions are preferable

$$\vec{u}^I + \sum_R \vec{u}^R = \sum_T \vec{u}^T, \quad \sigma_{3i}^I + \sum_R \sigma_{3i}^R = \sum_T \sigma_{3i}^T. \quad (6.10)$$

The harmonic waves are studied most frequently. It is expedient to write conditions (6.10) for this case. The first condition – the condition of displacement continuity on the interface – will be as follows

$$u_i^{oI} e^{i(\vec{k}^I \vec{r} - \omega^I t)} + \sum_R u_i^{oR} e^{i(\vec{k}^R \vec{r} - \omega^R t)} = \sum_T u_i^{oT} e^{i(\vec{k}^T \vec{r} - \omega^T t)}. \quad (6.11)$$

It follows from condition (6.11) that for the arbitrary moment the frequencies of all the waves, which are forming after arriving some wave on the interface, are identical with the frequency of arrived (incident) wave

$$\omega^R = \omega^T = \omega^I.$$

Thus the plane harmonic wave does not change its frequency when being refracted.

The second corollary from condition (6.11) is that one more condition fulfils on the interface $\vec{k}^R \vec{r} = \vec{k}^T \vec{r} = \vec{k}^I \vec{r}$. It is usually written in the form $(\vec{k}^R - \vec{k}^I) \vec{r} = 0$, $(\vec{k}^T - \vec{k}^I) \vec{r} = 0$.

Note 6.4. Because the vector \vec{r} is lying in the interface plane, then last formulas can be treated as the refraction law like to Snell law in optics: **projections of all the wave vectors on the interface are identical; all the wave vectors are lying in the incident plane, which is defined by the normal to the interface \vec{i}_3 and the wave vector of incident wave \vec{r} .**

The first part of the law can be written by the formula including the incident angle θ^I , the reflection angle θ^R , and the refraction angle θ^T

$$k^R \sin \theta^R = k^T \sin \theta^T = k^I \sin \theta^I.$$

Conditions 2. The conditions of mechanical contact, which permit two elastic semi-spaces “to slide” one relative to another over the interface.

According to these conditions the normal to the contact plane displacements and stresses are equalling at the contact plane

$$u_3^{(1)}(x_1, x_2, 0, t) = u_3^{(2)}(x_1, x_2, 0, t), \quad \sigma_{33}^{(1)}(x_1, x_2, 0, t) = \sigma_{33}^{(2)}(x_1, x_2, 0, t). \quad (6.12)$$

In terms of the wave theory conditions (6.12) can be written in the form

$$u_3^I + \sum_R u_3^R = \sum_T u_3^T, \quad \sigma_{33}^I + \sum_R \sigma_{33}^R = \sum_T \sigma_{33}^T.$$

Conditions 3. The conditions of full mechanical contact of an elastic semi-space with a rigid body.

Please click the advert

STUDY FOR YOUR MASTER'S DEGREE IN THE CRADLE OF SWEDISH ENGINEERING

Chalmers University of Technology conducts research and education in engineering and natural sciences, architecture, technology-related mathematical sciences and nautical sciences. Behind all that Chalmers accomplishes, the aim persists for contributing to a sustainable future – both nationally and globally.

Visit us on Chalmers.se or [Next Stop Chalmers](#) on facebook.



CHALMERS
UNIVERSITY OF TECHNOLOGY

Download free ebooks at bookboon.com

Because the local displacements and waves do not propagate in the rigid body, then the conditions are as follows

$$u_i^{(1)}(x_1, x_2, 0, t) = 0, \sigma_{3i}^{(1)}(x_1, x_2, 0, t) = 0 \text{ or } u_i^I + \sum_R u_i^R = 0, \sigma_{3i}^I + \sum_R \sigma_{3i}^R = 0 \quad (i=1,2). \quad (6.13)$$

The conditions (6.13) reflect the clear physical fact that waves are reflecting from the rigid wall and the refracted waves do not exist.

Conditions 4. The conditions of mechanical contact of an elastic semi-space with a rigid body, which permit the elastic semi-space “to slide” over the interface.

Like to prior conditions, these conditions include three independent conditions. But if the prior ones (over the rigid wall) demand to vanish of all the three components of the displacement vector, then in the case in hand the normal component of the displacement vector and two tangent stresses in the boundary plane should be zero

$$u_3^{(1)}(x_1, x_2, 0, t) = 0, \sigma_{3i}^{(1)}(x_1, x_2, 0, t) = 0 \text{ or } u_3^I + \sum_R u_3^R = 0, \sigma_{3i}^I + \sum_R \sigma_{3i}^R = 0 \quad (i=1,2). \quad (6.14)$$

Conditions 5. The conditions of free boundary, when one of two elastic semi-spaces is either the vacuum, or when the solid body borders upon the gas or air in conditions of a low pressure.

The stresses in vacuum are absent and they are absent therefore at the interface. Moreover in this case the refracted waves are absent and the reflected waves exist only. So, the boundary conditions at the interface have the form

$$\sigma_{3i}^{(1)}(x_1, x_2, 0, t) = 0 \text{ or } \sigma_{3i}^I + \sum_R \sigma_{3i}^R = 0. \quad (6.15)$$

These boundary conditions generate some special situations, which will be discussed in Comments.

Comments

The plane harmonic waves are the most characteristic in understanding the waves in whole. Therefore we recommend strongly to study these waves very thoroughly. This will be generously repaid afterwards. It can be meant as the main battle for waves.

It is to the point here to remember the sentence of Niccolo Machiavelli that

the main battle which you are won done away with all the mistakes you made.

The first comment to plane waves is that in an anisotropic medium for each direction corresponding to the eigenvector, three plane waves with orthogonal polarizations and different phase velocities exist.

In the general case, the displacement vector and the eigenvector are not like-directed.

Then the wave which is the most close to the eigenvector direction is called the quasi-longitudinal wave. Two other waves are called the quasi-transverse waves.

But when the material has certain attributes of property symmetry, then waves can be become the pure longitudinal and pure transverse waves.

The classical theory of elasticity has been concentrated basically on materials of three types – orthotropic, transversally isotropic, and isotropic. The crystallography only has been studied the symmetry of properties. But when the waves being explored more in depth, the necessity to unite both theories together arises.

Let us cite here the statement from (Dieulesaint, E & Royer, D 1974, p57):

The elastic waves can propagate in any material medium, but their amplitude decreases with propagation time, because of interaction among atoms is not pure elastic. The absorption of waves is the lesser, the most ordered is the medium. Thus the loss in a fluid is more than in the solid, and in the amorphous or polycrystalline substance is more than in the monocrystal.

On the other hand, these losses increase very rapidly with frequency. Therefore the fluids can not be used on frequencies more 50 MHz and on frequencies of the order GHz the monocrystals only are used. Owing to anisotropy of crystals, certain directions are more favorable for propagation of any kind of waves; for example, the wave vector and the vector of energy flux are collinear along the special directions only. Moreover for excitation of the elastic waves of high frequency the piezocrystals are needed. For understanding the phenomena of propagation and generation of elastic waves, the clear knowledge of the crystal properties and especially their symmetry is necessary.

The second comment is related to the incident wave. Because the initial assumption is that the incident plane coincides with the coordinate plane x_1Ox_3 , then three waves only can be the incident ones:

1. The transverse wave, in which the displacement is perpendicular to the incident plane and which is characterized by displacements $u_2 \neq 0, u_1 = u_3 = 0$.
2. The transverse wave, in which the displacement is lying in the incident plane and which is characterized by displacements $u_1 \neq 0, u_3 \neq 0, u_2 = 0$.
3. The longitudinal wave, in which the displacement is lying in the incident plane and which is characterized by displacements $u_1 \neq 0, u_3 \neq 0, u_2 = 0$.

The third comment is associated with Conditions 5, when the propagating in elastic body waves arrive to the plane demarcating the body and vacuum.

Two situations will be commented below.

Situation 1. The incident transverse wave is polarized parallel to the interface plane. Then it is reflected fully and does not generate reflected longitudinal wave. It could be shown that such a situation is impossible for the arbitrary transverse wave. That is in the arbitrary case, **the incident transverse wave generates necessary the reflected longitudinal wave.**

Situation 2. The body is isotropic and the incident wave is the longitudinal one. This wave generates two reflected waves – longitudinal and transverse. It is expedient to introduce two notions:

1. **The reflection factor** of the longitudinal wave as the ratio of the reflected longitudinal wave amplitude to the incident wave amplitude.
2. **The factor of transformation** in the transverse wave as the ratio of the reflected transverse wave amplitude to the incident wave amplitude.

Some algebraic formulas can be obtained for these factors. As follows from the formulas, two cases of incident angle exist, when the first coefficient is zero. Namely, cases $55^{\circ}41'$ and 60° .

That is, an opportunity exists that the incident longitudinal wave generates the reflected transverse wave only.

It should be mentioned that just this mechanism is used in practice for transforming the longitudinal wave into the transverse one.

Bibliography

1. Achenbach, JD 1973, *Waves Propagation in Elastic Solids*. North-Holland, Amsterdam.
2. Brekhovskikh, LM & Goncharov, VV 1982, *Introduction to Mechanics of Continuum (In Application to Wave Theory)*. Nauka, Moscow. (In Russian)
3. Chen, PJ 1972, *Wave motion in solids*, Flugge's Handbuch der Physik, Band VIa / 3, Truesdell, C (ed), Springer Verlag, Berlin.
4. Dieulesaint, E & Royer, D 1974, *Ondes elastiques dans les solides. Application au traitement du signal*, Masson et C^{ie}, Paris. (In French)
5. Fedorov, FI 1975, *Theory of Elastic Waves in Crystals*. Academic Press, New York.
6. Graff, KF 1975, *Wave Motion in Elastic Solids*. Ohio State University, Columbus.
7. Tolstoy, I 1973, *Wave Propagation*. McGraw Hill, New York.

Questions

- 6.1. Can be introduced the tensor like to the Christoffel tensor for waves with non-plane fronts (for example, with cylindrical, spherical et cetera) ?
- 6.2. Are known the wave equations for materials with intermediate forms of the symmetry (among isotropic, transversely isotropic and orthotropic materials) ?
- 6.3. Can be assumed that the incident plane is inclined regarding to the coordinate planes ?
- 6.4. In which way the distinction between the cemented half-spaces and half-spaces allowing the sliding (with “the lubricant”) ?
- 6.5. In which way the contact conditions on the plane boundary will be changed, when to assume that the boundary has the form of surface (for example, cylindrical or spherical) ?

Please click the advert





it's an **interesting** world

Get under the skin of it.

Graduate opportunities
Cheltenham | £24,945 + benefits

One of the UK's intelligence services, GCHQ's role is two-fold: to gather and analyse intelligence which helps shape Britain's response to global events, and, to provide technical advice for the protection of Government communication and information systems. In doing so, our specialists – in IT, internet, engineering, languages, information assurance, mathematics and intelligence – get well beneath the surface of global affairs. If you thought the world was an interesting place, you really ought to explore our world of work.

www.careersinbritishintelligence.co.uk

Applicants must be British citizens. GCHQ values diversity and welcomes applicants from all sections of the community. We want our workforce to reflect the diversity of our work.







7 Rayleigh, Love, Lamb elastic waves

Rayleigh waves in the elastic half-space. Love waves in the elastic system 'layer – half-space'. Lamb waves in the elastic layer.

7.1 Surface waves

The surface waves can be defined as the waves propagating along the surface, which separates the elastic material and vacuum and is therefore the free surface. The free surface can have different configurations.

The main feature of surface wave is that its amplitude is maximal at the interface and decreases very rapidly, when the wave being gone from the interface.

It is assumed therefore that the wave is noticeable only in the near-the-surface layer. It can be formulated that if the wave is not concentrated at the near-the-surface layer, then it is not the surface one.

7.2 Rayleigh elastic waves

The theoretical solution of the problem on the surface waves has been given in 1885 by Rayleigh and very often such surface waves are called the Rayleigh waves. It is very characteristic example of theoretical prediction of important physical phenomenon.

The next important feature of surface waves is that usually their great amplitude and energy is observing comparing with the spatial longitudinal and transverse waves.

From point of view of the wave theory, the surface wave demonstrates that the free surface couples the independent in the infinite continuum longitudinal and transverse waves.

This coupling is displayed in that the surface wave is not polarized linearly. The particles are oscillating in the plane of wave propagation and contains therefore both longitudinal and the transverse components.

So, let the surface is the plane $x_3 = 0$, the material is isotropic and the direction of wave propagation is the abscissa axis. The problem becomes the plane one and does not depend on the coordinate x_2 . The general equations of motion (Lame equations) become simpler and can be written as two wave equations relative to two scalar potentials $\varphi(x_1, x_3, t), \psi(x_1, x_3, t)$

$$u_1(x_1, x_3, t) = \frac{\partial \varphi}{\partial x_1} + \frac{\partial \psi}{\partial x_3}, \quad u_2(x_1, x_3, t) = \frac{\partial \varphi}{\partial x_3} - \frac{\partial \psi}{\partial x_1},$$

$$\left(\Delta - \frac{1}{(v_L)^2} \frac{\partial}{\partial t^2} \right) \varphi = 0, \quad \left(\Delta - \frac{1}{(v_T)^2} \frac{\partial}{\partial t^2} \right) \psi = 0. \quad (7.1)$$

The boundary conditions $\sigma_{33}(x_1, 0, t) = 0$, $\sigma_{31}(x_1, 0, t) = 0$ reflect the absence of stresses on the free plane. They can be rewritten through potentials

$$\left\{ (v_L)^2 \frac{\partial^2 \varphi}{\partial x_3^2} + [(v_L)^2 - 2(v_T)^2] \frac{\partial^2 \varphi}{\partial x_1^2} - 2(v_T)^2 \frac{\partial^2 \psi}{\partial x_1 \partial x_3} \right\}_{x_3=0} = 0, \quad \left(2 \frac{\partial^2 \varphi}{\partial x_1 \partial x_3} + \frac{\partial^2 \psi}{\partial x_3^2} - \frac{\partial^2 \psi}{\partial x_3^2} \right)_{x_3=0} = 0.$$

Now the problem on the surface waves can be mathematically formulated as follows:

find the solution of equations (7.1) in the upper semi-plane $x_3 > 0$, if at the boundary $x_3 = 0$ the stresses are absent and the solution has the form of harmonic wave propagating along the boundary and has the amplitude decreasing with increasing the coordinate x_3 .

So, the solution is looking for the form

$$\varphi(x_1, x_3, t) = A_\varphi(x_3) e^{i(kx_1 - \omega t)}, \quad \psi(x_1, x_3, t) = A_\psi(x_3) e^{i(kx_1 - \omega t)}. \quad (7.2)$$

Substituting representation (7.2) into wave equations (7.1) gives

$$A_\varphi(x_3) = A_\varphi^0 e^{-\sqrt{k^2 - k_L^2} x_3}, \quad A_\psi(x_3) = A_\psi^0 e^{-\sqrt{k^2 - k_T^2} x_3}, \quad k^2 - k_L^2 > 0, \quad k^2 - k_T^2 > 0,$$

$$\varphi(x_1, x_3, t) = A_\varphi^0 e^{i(kx_1 - \omega t) - \sqrt{k^2 - k_L^2} x_3}, \quad \psi(x_1, x_3, t) = A_\psi^0 e^{i(kx_1 - \omega t) - \sqrt{k^2 - k_T^2} x_3}. \quad (7.3)$$

Substituting solution (7.3) into boundary conditions gives the linear algebraic equations relative amplitudes, then determinant of the system is assumed to be zero and the equation for the wave number or the phase velocity of surface wave is obtained as follows

$$\left[2k^2 - \left(\frac{v_L}{v_T} \right)^2 k_T^2 \right] (2k^2 - k_T^2) - 4k^2 \sqrt{(k^2 - k_L^2)(k^2 - k_T^2)} = 0, \quad \text{or}$$

$$\theta \left\{ \theta^3 - 8(\theta - 1) \left[\theta - 2 \left(\frac{v_L}{v_T} \right)^2 \right] \right\} = 0, \quad \theta \equiv \left(\frac{v_R}{v_T} \right)^2. \quad (7.4)$$

Note 7.1. Coefficients of equation (7.4) do not depend on frequency. Therefore any root of equation will not depend on frequency. Thus, if the phase velocity of surface wave will be found, then it will not depend on frequency. This means that Rayleigh wave is nondispersive one as all the elastic waves studied up to this moment in the book.

During last 100 and more years many variants to find the proper root of equation (7.4) are proposed. All the variant gives the result that the surface wave exists, is harmonic and nondispersive. Among different formulas for the phase velocity v_R the next approximate Victorov's formula is often used in the practice

$$v_R \approx v_T \frac{0.718 - (v_T/v_L)^2}{0.75 - (v_T/v_L)^2}.$$

Note 7.2. It follows from representation of potentials (7.3) that the first potential decreases more quickly than the second one. This means that starting with some depth the Rayleigh wave becomes quite the shear wave.

The formulas for evaluation of displacements are as follows

$$u_1(x_1, x_3, t) = A_\psi^o \left[\frac{2k_R^2 \sqrt{k_R^2 - k_L^2}}{2k_R^2 - k_T^2} e^{-\sqrt{k_R^2 - k_L^2} x_3} - \sqrt{k_R^2 - k_T^2} e^{-\sqrt{k_R^2 - k_T^2} x_3} \right] e^{i(k_R x_1 - \omega t)}, \quad (7.5)$$

$$u_3(x_1, x_3, t) = iA_\psi^o \left[\frac{2k_R^2 \sqrt{k_R^2 - k_L^2}}{2k_R^2 - k_T^2} e^{-\sqrt{k_R^2 - k_L^2} x_3} - k_R e^{-\sqrt{k_R^2 - k_T^2} x_3} \right] e^{i(k_R x_1 - \omega t)}, \quad (7.6)$$

Note 7.3. Two moments in formulas (7.6) should be commented. The first one is associated with presence in the formula for u_3 the factor i . The real displacements are evaluated as the real part of expressions (7.6). The presence of imaginary unit means that the oscillations of particles in direction Ox_1 and the oscillations of particles in direction Ox_3 differ by the phase on $\pi/2$.

The second moment is related to distinction of displacements by the amplitude. This distinction means that the oscillation of separate particle occurs in the sagittal plane and the motion of each particle occurs by the elliptic trajectory. The form of the ellipse is changed with distance from the boundary.



HORIZONS UNIVERSITY

In Paris or Online

International programs taught by professors and professionals from all over the world

- BBA in Global Business
- MBA in International Management / International Marketing
- DBA in International Business / International Management
- MA in International Education
- MA in Cross-Cultural Communication
- MA in Foreign Languages

Innovative – Practical – Flexible – Affordable

Visit: www.HorizonsUniversity.org

Write: Admissions@horizonsuniversity.org

Call: 01.42.77.20.66

www.HorizonsUniversity.org

Please click the advert



7.3 Love elastic waves

The initial point is that the Rayleigh surface waves have the feature that they are polarized in the plane of wave propagation.

In the famous publication of 1911 Love has been shown, that the surface waves exist, which are differing from the Rayleigh waves. These waves have the transverse polarization and can arise in the elastic half-space, on the boundary plane of which the thin elastic layer with properties differing from the half-space properties is deposited.

Consider the problem in the statement similar to the Rayleigh problem. So, consider the upper half -space $Ox_1x_2x_3$, which is assumed to be isotropic with the constant basic Lamé constants λ_2, μ_2 and density ρ_2 . The half-space is in the ideal mechanical contact on the boundary $x_2 = 0$ with the elastic layer of the thickness h ($-h \leq x_2 \leq 0$) and with mechanical properties λ_1, μ_1, ρ_1 . It is assumed also that the boundary is free (the stresses are absent on the boundary plane $x_2 = -h$).

The basic assumption is as follows:

the displacements in both components (half-space and layer) $u_1^{(\alpha)}, u_2^{(\alpha)}$ are absent; in direction of the axis Ox_2 (along the plane of separation of half-space and layer) the transverse polarized wave is propagating

$$\vec{u}^{(\alpha)} = (0; 0; \tilde{u}_3^{(\alpha)}(x_1)) e^{i(kx_2 - \omega t)}. \quad (7.7)$$

Note 7.4. It follows from representation (7.7) that differing from zero stresses will be also not much in this problem: the shear stresses σ_{31}, σ_{32} only.

The motion in both components will be described by the basic Lamé equations with differing physical constants. Because the motion is quite simple (it consists of one component u_3 only), then two scalar wave equations only will describe the problem

$$\left[\mu_\alpha \left(\frac{\partial^2}{\partial x_1^2} + \frac{\partial^2}{\partial x_2^2} \right) - \rho_\alpha \frac{\partial^2}{\partial t^2} \right] u_3^{(\alpha)}(x_1, x_2, t) = 0. \quad (7.8)$$

Substituting representation (7.7) in equations (7.8) gives two ordinary differential equations

$$\left[\frac{\partial^2}{\partial x_1^2} - (-1)^\alpha (\beta^{(\alpha)} k_{Love})^2 \right] \tilde{u}_3^{(\alpha)}(x_1) = 0 \quad k_{Love} = \frac{\omega}{v_{Love}},$$

layer $\alpha = 1$: $x_1 \in [-h, 0]$, $\beta^{(1)} = \left(\frac{v_{Love}}{v_T^{(1)}} \right)^2$, $(v_T^{(1)})^2 = \frac{\mu_1}{\rho}$,

half-space $\alpha = 2$: $x_1 \geq 0$, $\beta^{(2)} = \left(\frac{v_{Love}}{v_T^{(2)}} \right)^2$, $(v_T^{(2)})^2 = \frac{\mu_2}{\rho}$.

The solution of the first equation is looking for the harmonic functions

$$\tilde{u}_3^{(1)}(x_1) = A^{(11)} \sin(k_{Love} \beta^{(1)} x_1) + A^{(12)} \cos(k_{Love} \beta^{(1)} x_1) \quad (7.9)$$

$$\text{with the condition } \left(\beta^{(1)}\right)^2 = \left(\frac{v_{Love}}{v_T^{(1)}}\right)^2 - 1. \quad (7.10)$$

Note 7.5. The condition (7.10) means that the Love wave phase velocity must be more than the phase velocity of the shear wave in the layer.

The solution of the second equation is chosen as exponentially decreasing one. Otherwise the Love wave will be not the surface wave because it will be not localized at the near-the-layer from the side of half-space. The solution is as follows

$$\tilde{u}_3^{(2)}(x_1) = A^{(22)} e^{-k_{Love} \beta^{(2)} x_1}. \quad (7.11)$$

$$\text{with the condition } \left(\beta^{(2)}\right)^2 = 1 - \left(\frac{v_{Love}}{v_T^{(2)}}\right)^2. \quad (7.12)$$

Note 7.6. The condition (7.12) means that the Love wave phase velocity must be less than the phase velocity of shear wave in the semi-space.

Note 7.7. The conditions (7.10) and (7.12) do not contradict with each other, when the wave phase velocity of transverse waves in semi-space exceeds the shear wave phase velocity in the layer.

Thus the condition of existence of Love waves can be written in the form

$$v_T^{(2)} > v_{Love} > v_T^{(1)}. \quad (7.13)$$

To determine the solution fully, it is necessary to consider the boundary conditions on planes $x_1 = -h$ and $x_1 = 0$.

On the plane $x_1 = -h$, the stresses are absent and the condition has the form $\left(\partial \tilde{u}_3^{(1)} / \partial x_1\right)_{x_1=-h} = 0$ or $A^{(11)} \cos(k_{Love} \beta^{(1)} h) + A^{(12)} \sin(k_{Love} \beta^{(1)} h) = 0$.

On the plane $x_1 = 0$ the conditions of full mechanical contact should be fulfilled

$$u_3^{(1)}(-0, x_2, t) = u_3^{(2)}(+0, x_2, t), \quad \mu_1 \left(\partial u_3^{(1)} / \partial x_1\right)_{x_1=0} = \mu_2 \left(\partial u_3^{(2)} / \partial x_1\right)_{x_1=+0},$$

$$\text{or } A^{(12)} = A^{(22)}, \quad \mu_1 \beta^{(1)} A^{(11)} = -\mu_2 \beta^{(2)} A^{(12)}.$$

Thus all the three constants are expressed through one constant.

The phase velocity of Love waves should be determined from the transcendent equation

$$\left[\mu_1 \sqrt{1 - \left(\frac{v_{Love}}{v_T^{(2)}}\right)^2} / \mu_2 \sqrt{\left(\frac{v_{Love}}{v_T^{(1)}}\right)^2 - 1} \right] = \tan \left[\frac{\omega h}{v_{Love}} \sqrt{\left(\frac{v_{Love}}{v_T^{(1)}}\right)^2 - 1} \right]. \quad (7.14)$$

The presence in equation (7.14) the frequency under tangent sign testifies that the phase velocity of Love waves will depend nonlinearly on frequency.

This is the direct attribute of dispersivity of the Love waves.

The equation (7.14) has the countable set of roots. On each interval of tangent one-valuedness, the tangent is continuous function and according to the classical Weierstraß theorem on the intermediate value has the unique solution.

**The Love wave has the countable set of modes
(the wave corresponding to one root is called the mode).**

7.4 Lamb elastic waves

Let the layer is given bounded by planes $x_3 = \pm h$. It can be meant as the infinite plate of the constant thickness. Let also the boundaries $x_3 = \pm h$ are free of stresses.

Definition 7.1. The waves propagating in the layer in direction along the boundaries are called the Lamb waves. Sometimes these waves are called the normal waves in the plate.

Note 7.8. Firstly such waves were studied by Rayleigh (1889) and Lamb (1916) within the framework of the plane problem of theory of elasticity, when parameters of the problem do not depend on coordinate x_2 .

Please click the advert

Nido

Luxurious accommodation

Central zone 1 & 2 locations

Meet hundreds of international students

BOOK NOW and get a £100 voucher from voucherexpress

Nido Student Living - London

Visit www.NidoStudentLiving.com/Bookboon for more info.

+44 (0)20 3102 1060

Download free ebooks at bookboon.com

Let us introduce the potentials (7.1) from the Rayleigh problem and find the solution in the form of harmonic waves

$$\varphi(x_1, x_3, t) = \left(\varphi^o \sinh k_{Lamb}^L x_3 + \varphi^{oo} \cosh k_{Lamb}^L x_3 \right) e^{i(k_{Lamb} x_1 - \omega t)},$$

$$\psi(x_1, x_3, t) = \left(\psi^o \sinh k_{Lamb}^T x_3 + \psi^{oo} \cosh k_{Lamb}^T x_3 \right) e^{i(k_{Lamb} x_1 - \omega t)}.$$

Here the unknown wave number of Lamb waves is denoted as $k_{Lamb} = (\omega/v_{Lamb})$, the notation $k_{Lamb}^L = \sqrt{k_{Lamb}^2 - k_L^2}$, $k_{Lamb}^T = \sqrt{k_{Lamb}^2 - k_T^2}$ is adopted and the unknown constants $\varphi^o, \varphi^{oo}, \psi^o, \psi^{oo}$ must be found from the boundary conditions.

The displacements are expressed through potentials by formulas

$$u_1(x_1, x_3, t) = \frac{\partial \varphi}{\partial x_1} + \frac{\partial \psi}{\partial x_3}, \quad u_3(x_1, x_3, t) = \frac{\partial \varphi}{\partial x_3} - \frac{\partial \psi}{\partial x_1}.$$

The boundary conditions are as follows

$$\sigma_{33}(x_1, \pm h, t) = 0, \quad \sigma_{31}(x_1, \pm h, t) = 0. \quad (7.15)$$

Substitution the sought solution into conditions (7.15) gives algebraic homogeneous system relative to four amplitude factors $\varphi^o, \varphi^{oo}, \psi^o, \psi^{oo}$. This system is split into two independent systems.

The first system is associated with two amplitudes φ^o, ψ^{oo}

$$\varphi^o \left[k_{Lamb}^2 + (k_{Lamb}^T)^2 \right] \cosh k_{Lamb}^L h + 2i\psi^{oo} k_{Lamb} k_{Lamb}^T \cosh k_{Lamb}^T h = 0,$$

$$2i\varphi^o k_{Lamb} k_{Lamb}^T \sinh k_{Lamb}^L h - \psi^{oo} \left[k_{Lamb}^2 + (k_{Lamb}^T)^2 \right] \sinh k_{Lamb}^T h = 0.$$

The second system is associated with two amplitudes φ^{oo}, ψ^o

$$\varphi^{oo} \left[k_{Lamb}^2 + (k_{Lamb}^T)^2 \right] \sinh k_{Lamb}^L h + 2i\psi^o k_{Lamb} k_{Lamb}^T \sinh k_{Lamb}^T h = 0,$$

$$2i\varphi^{oo} k_{Lamb} k_{Lamb}^T \cosh k_{Lamb}^L h - \psi^o \left[k_{Lamb}^2 + (k_{Lamb}^T)^2 \right] \cosh k_{Lamb}^T h = 0.$$

Equating the determinants of systems above to zero gives as usually the characteristic equations for wave numbers

$$\frac{\tanh k_{Lamb}^L h}{\tanh k_{Lamb}^T h} = \frac{\left[k_{Lamb}^2 + (k_{Lamb}^T)^2 \right]^2}{4k_{Lamb}^2 k_{Lamb}^L k_{Lamb}^T}, \quad \frac{\tanh k_{Lamb}^T h}{\tanh k_{Lamb}^L h} = \frac{\left[k_{Lamb}^2 + (k_{Lamb}^L)^2 \right]^2}{4k_{Lamb}^2 k_{Lamb}^L k_{Lamb}^T}. \quad (7.16)$$

The corresponding solutions are as follows

$$\varphi_{sym}(x_1, x_3, t) = \varphi^o \sinh k_{Lamb}^{Lsym} x_3 e^{i(k_{Lamb}^{sym} x_1 - \omega t)}, \quad \psi^{sym}(x_1, x_3, t) = \Psi^{sym} \varphi^o \sinh k_{Lamb}^{Lsym} x_3 e^{i(k_{Lamb}^{sym} x_1 - \omega t)}, \quad (7.17)$$

$$\Psi^{sym} = \frac{2ik_{Lamb}^{sym} k_{Lamb}^{Lsym} \sinh k_{Lamb}^{Lsym} h}{\left[(k_{Lamb}^{sym})^2 + (k_{Lamb}^{Tsym})^2 \right] \sinh k_{Lamb}^{Tsym} h}. \quad k_{Lamb}^{(L)sym} = \sqrt{(k_{Lamb}^{sym})^2 - k_L^2}, \quad k_{Lamb}^{(T)sym} = \sqrt{(k_{Lamb}^{sym})^2 - k_T^2},$$

$$\varphi_{ant}(x_1, x_3, t) = \varphi^{oo} \sinh k_{Lamb}^{Lant} x_3 e^{i(k_{Lamb}^{ant} x_1 - \omega t)}, \quad \psi^{ant}(x_1, x_3, t) = \Psi^{ant} \varphi^o \sinh k_{Lamb}^{Lant} x_3 e^{i(k_{Lamb}^{ant} x_1 - \omega t)}, \quad (7.18)$$

$$\Psi^{ant} = \frac{2ik_{Lamb}^{ant} k_{Lamb}^{Lant} \cosh k_{Lamb}^{Lant} h}{\left[(k_{Lamb}^{ant})^2 + (k_{Lamb}^{Tant})^2 \right] \cosh k_{Lamb}^{Tant} h}. \quad k_{Lamb}^{(L)ant} = \sqrt{(k_{Lamb}^{ant})^2 - k_L^2}, \quad k_{Lamb}^{(T)ant} = \sqrt{(k_{Lamb}^{ant})^2 - k_T^2}.$$

The solution (7.17) has the main peculiarity that it corresponds to waves, in which the longitudinal motion of particles occurs symmetrically and the transverse motion of particles occurs anti-symmetrically relative to the middle surface of the layer $x_3 = 0$. The next formulas for displacements reflect this fact

$$u_1^{sym}(x_1, x_3, t) = \tilde{u}_1^{sym} k_{Lamb}^{sym} \left[\frac{\cosh k_{Lamb}^{(L)sym} x_3}{\sinh k_{Lamb}^{(L)sym} h} - \frac{2k_{Lamb}^{sym} k_{Lamb}^{(L)sym}}{(k_{Lamb}^{sym})^2 + (k_{Lamb}^{(T)sym})^2} \frac{\cosh k_{Lamb}^{(T)sym} x_3}{\sinh k_{Lamb}^{(T)sym} h} \right] e^{i(k_{Lamb}^{sym} x_1 - \omega t - \frac{\pi}{2})}, \quad (7.19)$$

$$u_3^{sym}(x_1, x_3, t) = -\tilde{u}_1^{sym} k_{Lamb}^{(L)sym} \left[\frac{\sinh k_{Lamb}^{(L)sym} x_3}{\sinh k_{Lamb}^{(L)sym} h} - \frac{2(k_{Lamb}^{sym})^2}{(k_{Lamb}^{sym})^2 + (k_{Lamb}^{(T)sym})^2} \frac{\sinh k_{Lamb}^{(T)sym} x_3}{\sinh k_{Lamb}^{(T)sym} h} \right] e^{i(k_{Lamb}^{sym} x_1 - \omega t)}. \quad (7.20)$$

Definition 7.2. The waves (7.19),(7.20) are called **the symmetric Lamb waves**.

Analogously, solution (7.18) has the main peculiarity that it corresponds to waves, in which the longitudinal motion of particles occurs anti-symmetrically and the transverse motion of particles occurs symmetrically relative to the middle surface of the layer $x_3 = 0$. The next formulas for displacements reflect this fact

$$u_1^{ant}(x_1, x_3, t) = -\tilde{u}_1^{ant} k_{Lamb}^{(L)ant} \left[\frac{\sinh k_{Lamb}^{(L)ant} x_3}{\cosh k_{Lamb}^{(L)ant} h} - \frac{2k_{Lamb}^{(L)ant} k_{Lamb}^{(T)ant}}{(k_{Lamb}^{ant})^2 + (k_{Lamb}^{(T)ant})^2} \frac{\sinh k_{Lamb}^{(T)ant} x_3}{\cosh k_{Lamb}^{(T)ant} h} \right] e^{i(k_{Lamb}^{ant} x_1 - \omega t - \frac{\pi}{2})}, \quad (7.21)$$

$$u_3^{ant}(x_1, x_3, t) = -\tilde{u}_1^{ant} k_{Lamb}^{(L)ant} \left[\frac{\cosh k_{Lamb}^{(L)ant} x_3}{\cosh k_{Lamb}^{(L)ant} h} - \frac{2(k_{Lamb}^{sym})^2}{(k_{Lamb}^{sym})^2 + (k_{Lamb}^{(T)sym})^2} \frac{\cosh k_{Lamb}^{(T)sym} x_3}{\cosh k_{Lamb}^{(T)sym} h} \right] e^{i(k_{Lamb}^{sym} x_1 - \omega t)}. \quad (7.22)$$

Definition 7.3. The waves (7.21),(7.22) are called **the anti-symmetric Lamb waves**.

Next important peculiarity of the Lamb waves is that they are dispersive ones, because the characteristic equations give roots with the nonlinear dependence on frequency.

The third peculiarity consists in that for given frequency and layer thickness the finite number of symmetric and anti-symmetric Lamb waves exist. For evaluation of the number of Lamb waves with given frequency and layer thickness, the next formulas are used often

$$N_{sym} = 1 + \left[\frac{2h}{\lambda_T} \right] + \left[\frac{2h}{\lambda_L} + \frac{1}{2} \right], \quad N_{ant} = 1 + \left[\frac{2h}{\lambda_L} \right] + \left[\frac{2h}{\lambda_T} + \frac{1}{2} \right].$$

In these formulas, the bracket means the whole part of the number under bracket.

Please click the advert

UNIVERSITY OF COPENHAGEN



Copenhagen Master of Excellence

Copenhagen Master of Excellence are two-year master degrees taught in English at one of Europe's leading universities

Come to Copenhagen - *and aspire!*

Apply now at
www.come.ku.dk

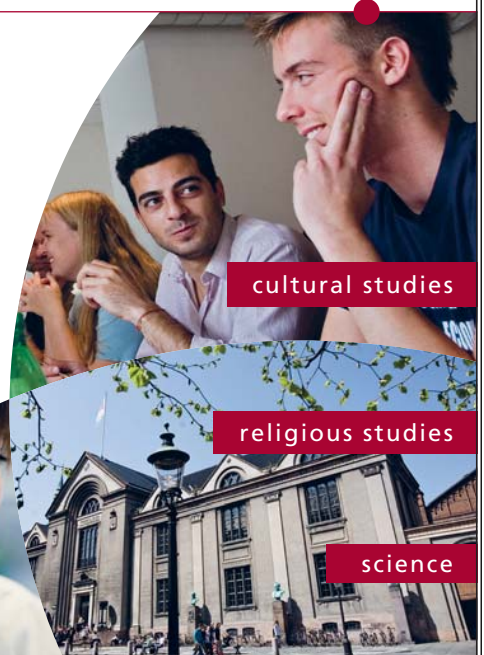

cultural studies

religious studies

science

Download free ebooks at bookboon.com

So, the chapter-lecture involves three basic messages:

1. **The Rayleigh wave is a classical example in the theory of elastic materials, that presence of the boundary in the mathematical model of material introduces additional complications in description of waves in the material. In particular, new type of waves – surface waves – can be generated.**
2. **The Lamb wave is a classical example in the theory of elastic materials that the bounded bodies (infinite layers) have the feature: waves in such media of propagation become dispersive owing to new mechanism, consisting of multiple reflections of propagated waves from the boundary and forming the averaged effect of geometrical dispersion.**
3. **The Love wave is a classical example in the theory of elastic materials that the infinite layers as covering the massive bodies have additional feature: energy of wave motion can transfer from the covering to the substrate; the frequency cut is absent et cetera.**

Comments

The full understanding the presented in this chapter three types of waves discovered by three prominent scholars needs (as many great results of great scholars) two great basis of the Roman:

the lucidity of mind and the sense of proportion -

and, of course, reading many excellent books.

The first comment to surface waves is that their propagation in an anisotropic material distinguishes well from the case of isotropic material. The book (Dieulesaint, E & Royer, D 1974) shows, for example, five essential distinctions.

The second comment is related to the surface waves damping. As a measure of amplitude decreasing the distance from the boundary, on which the amplitude decreases in $(1/e)$ times, can be chosen. Then for amplitudes $A_\varphi(x_3)$ (because of the

relationship $A_\psi = -\frac{2ik_R\sqrt{k_R^2 - k_L^2}}{2k_R^2 - k_T^2} A_\varphi$) such a distance is $d_\varphi = \frac{1}{\sqrt{k_R^2 - k_L^2}} = \frac{1}{k_L\sqrt{1 - (v_R/v_L)^2}} = \frac{\lambda_L}{2\pi\sqrt{1 - (v_R/v_L)^2}}$,

$$d_\psi = \frac{1}{\sqrt{k_R^2 - k_T^2}} = \frac{1}{k_T\sqrt{1 - (v_R/v_T)^2}} = \frac{\lambda_T}{2\pi\sqrt{1 - (v_R/v_T)^2}}.$$

These formulas show that distances d_φ, d_ψ are commensurable with the longitudinal and transverse wave lengths and hence are commensurable with the surface wave length also. So, the shorter are surface waves, the more they are localized near the surface and the narrower is the layer, in which they propagate.

But for all that the fact must be remembered that when the wave length becomes commensurable with the characteristic size of the internal structure of material, then the basic model of elastic body is already not true.

The third comment is associated with the dispersivity of the Love wave. This feature is associated with that the Love wave is already not the free wave. The free waves in elastic materials are always nondispersive ones. Just a presence in the layer two boundary planes causes the geometrical dispersion.

At this step the modes should be commented. They have a row of features. First of all, each mode has the feature that with increasing the frequency the part of energy transporting by the mode in layer increases. While being moved to the low frequencies, the layer stops with wave energy concentration. In this case, the quite full transport of energy can be reached into the wave propagating in the half-space.

Secondly, the wave in the half-space is damped less and less, when the mode number being increased. That is, the Love wave on the high modes penetrates more strongly from the layer into the half-space, on which the layer is lying.

Let us comment also **the modes of Lamb waves**.

The characteristic quantity for number of roots is the product of frequency on the layer half-thickness ωh . Waves are numerated and called the zero mode (zero form, zero wave), then the first mode, the second mode et cetera. For $\omega h \rightarrow 0$ both characteristic equations have one only root corresponding to the zero mode of symmetric and anti-symmetric waves.

It should be mentioned that the zero mode exists always for arbitrary frequencies and thicknesses. The phase velocities for all the modes are changing depending on the number of modes and are usually evaluated numerically.

Finally a few words about the limit cases of **the phase velocities of Lamb waves**. The parameter $k_2^{(T)}h$ is the convenient tool for this analysis. Then for zero modes, when the parameter $k_2^{(T)}h$ is changed from zero to infinity, the phase velocity is changed: for symmetric waves from $\frac{2v_2^T}{\sqrt{3}v_2^L} \sqrt{(v_2^L)^2 - (v_2^T)^2}$ to the phase velocity of Rayleigh waves; for anti-symmetric waves from $\frac{2v_2^T}{\sqrt{3}v_2^L} k_2^{(T)}h \sqrt{(v_2^L)^2 - (v_2^T)^2}$ to the phase velocity of Rayleigh waves.

In the case of thin plate (thin layer) the zero modes are practically the bending wave in thin plate for the anti-symmetric mode and the longitudinal wave in the thin plate for the symmetric mode.

For the non-zero modes, the phase velocities are changing from zero to the phase velocity of transverse waves and are strongly depending on frequency. That is the non-zero modes are the dispersive waves.

Further reading

1. Achenbach, JD 1973, *Wave Propagation in Elastic Solids*. North-Holland, Amsterdam.
2. Chen, PJ 1972, *Wave motion in solids*, Flügge's Handbuch der Physik, Band YIa / 3, Ed. C.Truesdell, Springer Verlag, Berlin.
3. Dieulesaint, E & Royer, D 1974, *Ondes elastiques dans les solides. Application au traitement du signal*, Masson et C'ie, Paris. (In French)
4. Farnell, GW 1972, *Elastic surface waves*. In: Physical Acoustics. Vol.6. Eds. Mason, WP & Thurston, RN, Academic Press, New York, 139-201.
5. Graff, KF 1975, *Wave Motion in Elastic Solids*. Ohio State University, Columbus.
6. Nowacki, W 1970, *Theory of Elasticity*. PWN, Warszawa. (In Polish)

7. Tolstoy, I 1973, *Wave Propagation*. McGraw Hill, New York.
8. Sedov, LI 1970, *Mechanics of Continuum*. In 2 volumes, vol.2, Nauka, Moscow. (In Russian)
9. Stoneley, R 1924, 'Elastic waves at the surface of separation of two solids', *Proc. Roy. Soc. London*. **A106** No.732 416-428.
10. Viktorov, IA 1967, *Rayleigh and Lamb waves*. Plenum Press, New York.

Questions

- 7.1. Whether depends the depth of penetration of the Rayleigh wave on the wave frequency?
- 7.2. Which new features arise, when the surface wave moves along the cylindrical or spherical surface?
- 7.3. Will change the characteristics of the cylindrical surface wave depending on that the body surface is concave or convex?
- 7.4. Which are conditions of existence of the surface Stoneley wave?
- 7.5. Which are conditions of existence of the surface Love wave?
- 7.6. On which parameters depends the phase velocity of Love wave? Comment the dependence on the layer thickness.
- 7.7. Which are conditions of existence of the surface Lamb wave?
- 7.8. Whether exist the limit values of the phase velocities of Lamb wave for non-zero modes?

Please click the advert

**THE BEST MASTER
IN THE NETHERLANDS**

Master of Science in Management

Kickstart your career. Start your MSc in Management in September, graduate within 16 months and join 15,000 alumni from more than 80 countries.

Are you ready to take the challenge? Register for our MSc in Management Challenge and compete to win 1 of 3 partial-tuition revolving scholarships worth €10,000!

www.nyenrode.nl/msc

NYENRODE
BUSINESS UNIVERSITEIT
A REWARD FOR LIFE

BEST MASTERS
KEUZEGIDS MASTERS 2012

*Keuzegids Higher Education Masters 2012, in the category of business administration

Download free ebooks at bookboon.com

8 Elastic waves. Structural linear models

Structural linear models. Short review of models. Structural model of mixtures of elastic materials. Shear and inertial mechanisms. Elastic constants

All structural theories exceeding the framework of macroscopic elastic constants theory, can be related to the materials structure of which is taken into account in their analysis. It should be noted that both the model of effective elastic constants and all the next models are based on knowledge of components properties and the internal structure as a whole.

Let us outline briefly the main structural models and corresponding theories.

Bolotin model of energy continualization

In Bolotin's studies, a variational approach was proposed for derivation of basic equations and boundary conditions, and conversion from microstructure to macrodescription was accomplished on the basis of the concept of simplifying the problem, which was reached by **spreading** - by change of a layered plate on one-layered anisotropic plate with characteristics of a stress-strain state, which continuously change with the thickness.

The author later defined more precisely the term **energy spreading** initially introduced, and this method is now called **the principle of energy continualization**.

The constructing of basic equations uses two assumptions:

A1. Arming elements are essentially more rigid than binding layers.

A2. The characteristic dimension of microstructure is small compared to characteristic dimensions of a body and to characteristic lengths of a change of functions describing a stress-strain state of arming elements.

As a result, the continuum equations of equilibrium for layered composite are obtaining

$$L_{\alpha k} u_k^* + X_\alpha^* = 0 \quad ; \quad L_{3k} u_k^* + h^2 M_{3k} u_k^* + X_3^* = 0 .$$

Here, $L_{\alpha k}, M_{3k}$ are linear differential operators of the second and fourth orders, respectively (the last introduce into the third equation the notion of effective stiffness); displacements u_k^* are chosen that in the middle plane of each layer they are equal approximately to displacements $u_k^{(m)}$ of this layer; potential energy of layered body is equal to potential energy of the equivalent quasihomogeneous body (the fictitious body); analogically, components of volume forces X_k are also *spread*; h is the characteristic thickness of reinforcing layers.

Note 8.1. Let us stop on the last characteristics h ; for a two-layered composite with alternating layers – soft and stiff – h corresponds to the stiff one thickness. Thus, the equations corresponding to the Bolotin model of effective stiffness include the dimensional quantity equal to the thickness of a stiff layer. In this way, the model becomes sensitive to transition, for example, from microlayers in 10 microns to nanolayers in 10 nanometers. It turned out afterward that other structural models possess this property too.

Note 8.2. Also, equations above have the peculiar characteristics for many of subsequent structural theories - they are analogous to equations of the moment theory of elasticity for anisotropic media. Besides them, the solutions will construct two parts: slowly varying inside of the layer, and quickly attenuated of the edge effect type.

The principle of energy continualization has been found to be fruitful, and has subsequently been used to formulate various continuum theories.

Achenbach-Hermann model of effective stiffness

This model is the most advanced model of the above-mentioned models. The modern description of this model is different from the first model proposed. The method of conversion from a discrete system of alternating layers or cells with an internal fiber to a continuum body is the principal method in the model, as in any structural model though. It includes several stages. The first stage consists in representation of displacements and describing the local effects excitations. In the case of fibrous composite of cellular checkerboard structure, the displacements for the cell (k, l) in the polar coordinate system with origin at the center of the fiber are represented in the form

$$u_i^{f(k,l)} = u_i^{(k,l)} + r \cos \Theta \psi_{2i}^{f(k,l)} + r \sin \Theta \psi_{3i}^{f(k,l)} \quad (r < a);$$

$$u_i^{m(k,l)} = u_i^{(k,l)} + a \cos \Theta \psi_{2i}^{m(k,l)} + a \sin \Theta \psi_{3i}^{m(k,l)} + (r - a) \cos \Theta \psi_{2i}^{m(k,l)} + (r - a) \sin \Theta \psi_{3i}^{m(k,l)} \quad (r > a).$$

The next step consists in the representation of internal and kinetic energies for cells as functions of displacements. The **spreading** operation is then carried out, and energy is determined at the fibre centre. Averaged global displacements are then equated to the displacements at the centre of fibre in the initial discrete cell system.

These averaged displacements define a new homogeneous continuum. The equality between energies in the discrete and spread cells complete the scheme of energy continualization. The density of strain energy in the new continuum depends on the effective moduli, but include additional constants depending on parameters of the microstructure and have sense of effective stiffness.

The model (theory) has been therefore named the model (theory) of effective stiffness.

At the final stage of the theory, the Hamilton principle construction is used. On the whole, continuum theories of different order were obtained as a function of the number of terms retained in the representations of the energy densities.

Models of effective stiffness of high orders

Drumheller and Bedford provide a bibliography on theories of effective stiffness of orders greater than the first one. They proposed a new approach, which makes it possible to construct a model of any order and can model stresses in layered composites.

The theory of effective stiffness permitted to investigate the problems of harmonic wave propagation in infinite layered and fibrous composites using the different variants of the model.

Like other approximate theories, the theory of effective stiffness poorly describes the properties of wave filtration by a layered medium during the propagation of waves normal to the layers. At the same time, the exact theory catches these characteristic features of waves well, and they are observed experimentally. A variant of the theory, which its authors call **the theory of equalized effective stiffness**, has been developed in order to improve description of the frequency spectrum to bring the latter as closely as possible to the exact description. This theory approximates well zones of wave cutting-off and transmission in layered media.

Note 8.3. Let us pay our attention to deficiency of the theory of effective stiffness, which are also characteristic of the theory of mixtures and other micro-structural theories. It is a question that such models describe only the first (lowest) modes. A series of experiments have confirmed for some time now, however, that the contribution of the first modes is dominant in the majority of cases. This is also required of approximate models.

Destination MMU



Manchester
Metropolitan
University

MMU is proud to be one of the most popular universities in the UK. Some 34,000 students from all parts of the globe select from its curricula of over 1,000 courses and qualifications.

We are based in the dynamic yet conveniently compact city of Manchester, located at the heart of a sophisticated transport network including a major international airport on the outskirts. Parts of the campus are acclaimed for their architectural style and date back over 150 years, in direct contrast to our teaching style which is thoroughly modern, innovative and forward-thinking.

MMU offers undergraduate and postgraduate courses in the following subject areas:

- Art, Design & Performance
- Computing, Engineering & Technology
- Business & Management
- Science, Environmental Studies & Geography
- Law, Education & Psychology
- Food, Hospitality, Tourism & Leisure Studies
- Humanities & Social Science



For more details or an application form please contact MMU International.
email: international@mmu.ac.uk
telephone: +44 (0)161 247 1022
www.mmu.ac.uk/international

Please click the advert

Asymptotic models of high orders

In the 1970's the theory of directionally reinforced (layered) composites has been proposed. It like the theory of effective stiffness, is based on the expansion of displacements. It is complementary supposed in this theory that the wave length is essentially larger than typical size of microstructure.

This assumption ensures the continualization.

Depending on the numbers of terms, which are retained in asymptotic expansions on small parameter obtained, the theories of various orders are built. The fact of asymptotic expansion is assumed here to be the main, and, in the connection of this, such a model is related to models, which are based on asymptotic expansions.

Note 8.4. This model differs essentially from the model of effective stiffness, since here the displacements contain the gradients of high orders and constitutive equations have the form of equations of materials of N th order.

Also the based on asymptotic expansions continuum approach to the layered continua was developed.

Within the framework of these models plane waves in layered composites were studied. On the whole, such continuum approaches give the better exactness in description of dispersion curves than many other theories.

Mindlin microstructural theory

This theory has a few features:

- A. **It is based on the notion of a vector-director.**
- B. **It has been one of the first structural theories.**
- C. **It was not further developed in theory and had not been used in practice.**

Mindlin was one of the first to construct the structural theory for materials with the repeated unit cell. Applicability to the determined cell structure constitutes an essence feature of this theory. The proposed by Mindlin microstructural theory is based on analysis of the cell as a linear variant of a deformable director.

Note 8.5. If the cell is considered as absolutely rigid during rotations, the microstructural model is reducing to the Cosserat model of moment continuum.

In the general case, the having its own microstructure cell is described on the microlevel by an elastic continuum, the linear deformation of which is characterized by three independent tensors:

T1. The tensor of macro strains $\varepsilon_{ij} = \frac{1}{2}(\partial_i u_j + \partial_j u_i)$. **T2. The tensor of relative strains** $\gamma_{ij} = \partial_i u_j - \psi_{ij}$. **T3. The tensor of micro strain gradient** $\kappa_{ijk} = \partial_i \psi_{jk}$.

Here, u_i are components of the macro displacements vector, and $\psi_{ij} = \partial_i' u_j'$ are the components of the tip of deformable director.

The continuum theory is constructed on the basis of formalism of the classical theory of elasticity using the assigned in the microstructural model kinematic parameters \mathcal{E}_{ij} , \mathcal{V}_{ij} , \mathcal{K}_{ijk} .

Note 8.6. Overwhelming difficulties arise in the determination of the physical constants of the theory. In fact, there are 903 constants in the general case, and 18 independent constants for the isotropic case (2 independent constants in the theory of elasticity, for example).

Eringen microstructural model. Eringen-Maugin model

Approximately at the same time with the above mentioned Mindlin microstructural model, Eringen and Suhubi proposed a model that they called **the micromorphic theory**. In this theory, the macrocontinuum is described by an elastic medium, each point x_k of which is additionally rigged with three deformable directors X_K (or one deformable vector-director \vec{X}). The micromorphic continuum is described by three kinematic tensors:

$$\text{The Green classical strain tensor } C_{KL} = x_{k,K} x_{k,L} .$$

$$\text{Two microstrain tensors } S_{KL} = x_{k,K} X_{k,L}, \Gamma_{KLM} = x_{k,K} X_{k,LM} .$$

Thereafter, the micromorphic model is constructed in the same way as the previous Mindlin model. In general, they are very similar.

Their fates have been completely different, however, even despite of their obvious abstractness.

The micromorphic theory has found unusual application in the theory of waves in piezoelectric materials - the so-called piezopowders with a small compacting become the granular composite materials.

Note 8.7. Where the subject of interest is wave propagation in granular powders such that the wave lengths are sufficiently close to the characteristic size of the internal structure (for example, the mayor diameter of the granule), a good approximation yields another structural model, the model of a mixture. This model gives a good approach for the linear and nonlinear wave investigation and will be discussed later.

Pobedrya microstructural theory

The classic micropolar approach arises, when the modern procedure of averaging is applied to the composite with the regularly repeated elementary cell. Such approach was proposed by Pobedrya. The written in displacements initial inhomogeneous problem of the linear theory of elasticity

$$\left[C_{ijkl}(x) u_{k,l} \right]_{,j} + X_i = \rho \frac{\partial^2 u_i}{\partial t^2}; \quad a_{ij}^\Sigma C_{jkl} u_{l,n} n_k + b_{ij}^\Sigma u_j = S_i^\Sigma;$$

$$u_i(x, 0) = U_i(x); \quad \frac{\partial u_i}{\partial t}(x, 0) = V_i(x)$$

is reduced to the recurrent sequence of written in displacements problems of the linear theory of elasticity for an anisotropic homogeneous medium with some effective elastic moduli

$$h_{ijmn} w_{m,nj}^{(k)} + X_i^{(k)} = \rho \frac{\partial^2 w_i^{(k)}}{\partial t^2}; \quad a_{ij}^{\Sigma} h_{jlmn} w_{m,n}^{(k)} n_i + b_{ij}^{\Sigma} w_j^{(k)} = S_i^{\Sigma(k)};$$

$$w_i^{(k)}(x, 0) = U_i^{(k)}(x); \quad \frac{\partial w_i^{(k)}}{\partial t}(x, 0) = V_i^{(k)}(x).$$

In addition, the solution $u_i(x, t)$ of initial problem is associated in sufficiently complicate form with the solution $w_i^{(k)}(x, t)$ of new problem

$$u_i(x, t) = \sum_{p+q=0}^{\infty} \alpha^{p+q} N_{ijk_1 \dots k_q}^{(p)}(\xi) \frac{\partial^p v_{j, k_1 \dots k_q}(x, t)}{\partial \tau^p}; \quad v_i = \sum_{\alpha=0}^{\infty} \alpha^k w_i^{(k)}.$$

Here, the small parameter α is equal to the ratio of the characteristic size of structure and the construction, and $\xi = x/\alpha$. The feature of the model is that in the null approximation the local displacement within the cell can be evaluated as $u_i = v_i + \alpha N_{ijk}(\xi) v_{j,k}(x)$.

Please click the advert



Develop the tools we need for Life Science

Masters Degree in Bioinformatics



Bioinformatics is the exciting field where biology, computer science, and mathematics meet.

We solve problems from biology and medicine using methods and tools from computer science and mathematics.

Read more about this and our other international masters degree programmes at www.uu.se/master

Download free ebooks at bookboon.com

In other notation, when the problem is written in stresses, this problem is reduced to the problem of moment homogeneous theory of elasticity. In one's turn, the moment problem is reduced to the recurrent sequence of problems of the theory of elasticity in stresses for anisotropic homogeneous medium with effective moduli of mechanical compliances. One considers that the procedure of evaluation of effective moduli of elasticity and compliance is well developed.

Note 8.8. Scheme of the structural theory permits, in theory's author opinion, to use successfully the modern numerical methods.

Structural model of elastic mixtures

This continuum structural model is marked out separately for that reason that, among all the structural models, it is the most developed. Its basic advantage consists in the fact that it can be constructed similar to the classical theory of elasticity, and in point of fact it can be meant as the direct generalization of the one-continuum model on the multi-continuum model with the same set of thermodynamical parameters.

First of all, it is necessary to note that multi-phase mixtures as an object of studies begun with the classical Fick (1855) and Stefan (1871) publications. **The concept of interpenetrating and interacting continua forms a theoretical basis.** In the consequence of that, all further development within the framework of such a concept theories are continuum ones.

The essence of the concept consists in that each geometrical point of a filled by the mixture domain (body) is simultaneously occupied by two (if a mixture is two-phase) or three (if a mixture is three-phase) particles (phases, components), between of which the relative motion occurs.

A construction of the adequate to composite materials mixture theory was begun by Lempriere, Bedford, Stern publications, in which the shear model of the force interaction between phases was proposed.

For layered composites an intuitive structural one-dimensional model was constructed, where it was observed that owing to the distinction of shear properties of layers, the macro interaction force arises between contacting layers, and it is directly proportional to difference of macrodisplacements in layers. In terms of the phenomenological mixture model, that means the force interaction between phases is directly proportional to the difference of phase displacements. This mechanism was called **the shear mechanism** by virtue of its physical nature.

Note 8.9. As it turned out, the shear mechanism introduces not dissipation into the mixture full energy and doesn't contradict the basic concept. It describes well the geometrical dispersion phenomenon, everywhere observed in wave processes in composite materials. The shear model demonstrates a high practicability of the mixture concept to composite materials and show the close interlink between the structural mixture theory and other various approaches in mechanics of composites.

A slightly more general concept of the linear model of elastic two-phase mixtures was proposed practically simultaneously in different works. First of all, it was shown that basic hypothesis of a linear elastic deformation admit only **two mechanisms of the force interaction - shear and inertial.**

The inertial interaction mechanism is caused by distinction in inertial properties of phases. It can be introduced formally by taking into account the phase cross-interaction in mixture kinetic energy as whole. This mechanism is essential in many type mixtures and was taken into account in many models.

Consider now the two-phase mixtures. Firstly, the basic hypothesis of any mixture theory should be adopted:

the microstructure of a two-phase composite can be described by two continua, the material particles of which are placed simultaneously at each geometric point of a domain and interact with each other.

Each continuum is characterized by its own set of field characteristics of **the partial density** $\rho_{\alpha\alpha}$, **the partial vector of displacements** $\vec{u}^{(\alpha)}$, and **the partial tensors of the stresses** $\sigma_{ik}^{(\alpha)}$, **strains** $\varepsilon_{ik}^{(\alpha)}$, and **rotations** $\omega_{ik}^{(\alpha)}$. Here and later, the Greek superscripts and Latin subscripts are equal to 1 and 2, and 1,2, and 3, respectively.

Definition 8.1. In accordance with traditions of mechanics of heterogeneous media, the parameter is named **partial** if it characterizes one phase only.

The basic equations of the theory of mixtures are deriving, assuming the laws of mass, momentum, angular momentum, and energy conservation are valid for the mixture.

It is necessary to note that:

1. The first three laws are always written for each component separately.
2. The theories of any mixtures are divided into two parts, depending on the law of energy conservation written either for each component separately or for a mixture as a whole. This division is essentially in view of its effects.

In the case “separately” the theory used the physical constants of each phase, whereas in the case “as a whole” the phase constants aren’t be used.

In the first variant, minus consists in that theoretical constants may differ very markedly from the real one, plus in return consists in that these constants were long ago written in handbooks.

In the second variant, minus consists in that the complete set of physical constants have to be determined from special experiments, and plus it consists in that the constants will more or less precisely correspond to the concrete structural material.

Writing the basic equations needs an introduction of some classical notions and symbols. Let the mixture fill the body with a volume V . The motion of each phase of the mixture is describing by the fixed orthogonal Cartesian coordinates.

Note 8.10. It should be noted that the equation of energy balance is a consequence of previous balance equations (mass, momentum, angular momentum), if the energy scattering isn’t taken into account in the mixture. Because it is usually assumed that the mixture is elastically deformed only, hence it is not taken into account.

The assumption about the elastic character of deformation leads to the theory of elastic mixtures. The assumption about linearity of deformation and all other processes simplifies the basic system of equations.

Consider somewhat more in detail the linear elastic model.

The mixture as a thermodynamical system is described by **three kinematical parameters: two partial strain tensors** $\varepsilon_{ik}^{(\alpha)}$ **and relative displacements vector** $(u_k^{(1)} - u_k^{(2)})$. Therefore, the internal energy of mixture as whole is represented as a function of these parameters

$$\mathcal{U} = \mathcal{U}(\varepsilon_{ik}^{(1)}, \varepsilon_{ik}^{(2)}, \omega_{ik}^{(1)}, \omega_{ik}^{(2)}, u_k^{(1)} - u_k^{(2)}).$$

After some classical simplifications and transformations of internal energy, the constitutive equations for a linear anisotropic mixture can be written as

$$\sigma_{ik}^{(\alpha)}(x, t) = c_{iklm}^{(\alpha)} \varepsilon_{lm}^{(\alpha)}(x, t) + c_{iklm}^{(3)} \varepsilon_{lm}^{(\delta)}(x, t) \quad (\alpha + \delta = 3).$$

At the beginning, to focus the attention on stresses and to remember that theoretically each phase of a mixture occupies simultaneously with other phases the elementary (unit) volume fully, whereas really all phases together occupy the same elementary volume and each phase occupies only its own part of the elementary volume. All partial quantities are therefore not quantities acting over a given phase. They are spread over all unit volume. For example, the partial stress tensor $\sigma_{ik}^{(\alpha)}$ should be considered as only the characteristic from a mixture model. To go to real stresses acting over the real phase, it is required to know the volume fraction of a given phase c_α . Then real stresses $\sigma_{ik}^{(\alpha)real}$ acting in a given phase of a mixture are equal to $\sigma_{ik}^{(\alpha)real} = \sigma_{ik}^{(\alpha)} / c_\alpha$.

In the linear theory, an interaction between mixture phases is described by **three mechanisms**. They are introducing into the linear theory by means of phenomenological considerations. The interaction force is represented as a sum of two forces, which characterize a change of kinetic and internal energies owing to the phase interaction, respectively. From the kinetic energy consideration follows that the phases interaction is displayed by the presence of a new additive term in the kinetic energy, which has the form of added mass energy. This mechanism is called **the inertial mechanism**.

The second mechanism consists in the cross influence of one phase strains on stresses of another phase. It is displayed in constitutive equations.

The third mechanism was initially offered for the one-dimensional model. Here, the interaction force is directly proportional to the relative displacement of phases at each point. This force in the layer composite, along layers of which the shear wave propagates, is the shear force over the boundary between layers. This mechanism is therefore called **the shear mechanism**. Owing to Bedford works the theory with such a type of interaction mechanism is called **the Bedford theory**. The basic system of equations of linear theory of elastic mixtures is constituted from the coupled system of six equations of the motion

$$\frac{\partial \sigma_{ik}^{(\alpha)}}{\partial x_i} + F_k^{(\alpha)} + (-1)^\alpha \left[\beta_k (u_k^{(1)} - u_k^{(2)}) - \rho_{12} \left(\frac{\partial^2 u_k^{(1)}}{\partial t^2} - \frac{\partial^2 u_k^{(2)}}{\partial t^2} \right) \right] = \rho_{\alpha\alpha} \frac{\partial^2 u_k^{(\alpha)}}{\partial t^2}.$$

and six linear constitutive equations, thus giving six coupled hyperbolic differential equations of the second order

$$c_{iklm}^{(\alpha)} \mathcal{E}_{lm,i}^{(\alpha)} + c_{iklm}^{(3)} \mathcal{E}_{lm,i}^{(\delta)} + F_k^{(\alpha)} + (-1)^\alpha \left[\beta_k (u_k^{(1)} - u_k^{(2)}) - \rho_{12} \left(\frac{\partial^2 u_k^{(1)}}{\partial t^2} - \frac{\partial^2 u_k^{(2)}}{\partial t^2} \right) \right] = \rho_{\alpha\alpha} \frac{\partial^2 u_k^{(\alpha)}}{\partial t^2}.$$

The next important fragment of the theory form the physical constants. There exist a few different approaches to the determination and clearing up of a physical sense of constants β_n , $c_{iklm}^{(\alpha)}$, ρ_{12} . There exist a common position on the method of determination of partial densities $\rho_{\alpha\alpha}$.

Definition 8.2. Each partial density $\rho_{\alpha\alpha}$ is not equal to the density of the separate phase ρ_α . It is the density of a separate phase spread over all unit volume. Therefore, the partial density is calculated by the formula $\rho_{\alpha\alpha} = \rho_\alpha c_\alpha$.

In some books from the list below, the simplest formulas for the evaluation of physical constants are shown, basing on the simplest considerations and deterministic concept. The approach, based on experiments, has no visible restrictions on a microstructure, but such experiments are very seldom used.

Consider now three classical cases of material symmetry and methods of evaluation of corresponding elastic constants based on plane wave propagation observation.

Isotropic mixture

It is necessary to determine 8 constants

$$a_1 = \lambda_1 + 2\mu_1; \mu_1; a_2 = \lambda_2 + 2\mu_2; \mu_2; a_3 = \lambda_3 + 2\mu_3; \mu_3; \rho_{12}, \beta$$

through two sets in fours of wave characteristics (one for the P-wave (longitudinal wave) and one for either the SH-wave (transverse horizontal wave) or the SV-wave (transverse vertical wave)).

Transversal-isotropic mixture

It is necessary to determine 18 constants

$$c_{11kk}^{(n)}, c_{3333}^{(n)}, c_{1313}^{(n)}, \beta_1 = \beta_2, \beta_3, \rho_{12}$$

through five sets in fours of the wave characteristics (in each set, one for a longitudinal wave (P-wave) and one for either a transverse horizontal wave (SH-wave) or a transverse vertical wave (SV-wave)).

Orthotropic mixture

It is necessary to determine 31 constants

$$c_{mkkk}^{(n)}, c_{1212}^{(n)}, c_{1313}^{(n)}, c_{2323}^{(n)}, \beta_n, \rho_{12}$$

through nine sets in fours of the wave characteristics (P-wave, SH-wave and SV-wave in three coordinate directions).

Comments

Diversity of structural models and their next development to applications testify the old Roman sentence

“multum, non multa” – “much in quantity, little in value”.

Let us start the comments with the Eringen-Maugin micromorphic model.

The three-stage evolution of piezomaterials can be distinguished at present. Piezoelectric phenomena were initially associated with crystals; because the structure of a single crystal satisfactorily characterized the material, however, a question of the material microstructure didn't arise here. It might seem, the discovery of piezoceramics and the study of waves in these materials could draw attention to the behavior of the components of the ceramics, *i.e.*, to their internal structure. But assumptions concerning the mechanical uniformity of a characteristic volume of ceramics and the domain structure of polarization were found, however, to be sufficient. Again, microstructure was found not to be necessary.

Only the study and use of the third generation of piezoelectric materials - the granulated piezoelectric powders - has finally forced to consider the microstructure of material in models of its piezoelectric behavior. This was done in the framework of the micromorphic theory, and later was continued for the mixture theory.

Please click the advert

MÄLARDALEN UNIVERSITY
SWEDEN

WELCOME TO OUR WORLD OF TEACHING!
INNOVATION, FLAT HIERARCHIES AND OPEN-MINDED PROFESSORS

STUDY IN SWEDEN - HOME OF THE NOBEL PRIZE
CLOSE COLLABORATION WITH FUTURE EMPLOYERS SUCH AS ABB AND ERICSSON

TAKE THE FAST TRACK

GIVE YOUR CAREER A HEAD START AT MÄLARDALEN UNIVERSITY
www.mdh.se

SASHA SHAHBAZI
LEFT IRAN FOR A MASTERS IN PRODUCT AND PROCESS DEVELOPMENT AND LOTS OF INNEBANDY
HE'LL TELL YOU ALL ABOUT IT AND ANSWER YOUR QUESTIONS AT MDUSTUDENT.COM

Download free ebooks at bookboon.com

It is rather natural to convert the theory of piezoelectricity to a micromorphic theory. With respect to piezoelectric powders consisting of a mixture of piezoceramic granules and usually granules of naphthalene or lead, it is expedient to use the microstructural model. In these powders, the electrical polarization, which is normally modeled by a vector field in physics, is the determining physical parameter. Moreover, it is easy to represent the domains in the form of such a microstructural characteristic as a granule. On the whole, the micromorphic theory elegantly explains a number of physical effects.

Let us remark that the studies of composite materials had one collateral consequence: they have been demonstrated as very expressive by the well-known physical principle: **the one and the same physical object can be investigated with the aim of different physical models depending on which phenomenon in the motion of this object is the main goal of study.**

As applied to composite materials, this principle was transformed in such a way: one and the same composite material can be described by a few tens of the various and, sometimes, very exotic models; all these models will be reasonable and expedient within the framework of some restrictions, which should be thoroughly fixed, and the procedure of such fixing is usually called **the fixing of the model practicability boundaries.**

It could be mentioned here the Helvetius sentence:

knowledge some of the principles fills a gap in our knowledge of some facts

One important consequence from observing plenty of models is worthy of a special attention: one and the same material in its description by different models will be described within the framework of each model by its own set of physical constants. Very often, sets for two distinct models have no coinciding constant. The determination of full sets of constants is the lamest point for structural theories. There exists the subconscious persuasion that material constants are **the thing in itself** and should not depend on choosing the model of this material. For example, the traditional understood density in a number of theories is changed on the set of densities.

**Therefore, the understanding of relativity of used for description
of materials set of physical constants must be considered the
one of unexpected value in structural mechanics of materials.**

Remember here the history of mixtures analysis. The most number of publications is observed in that part of mechanics of multi-phase mixtures, which studies the soils saturated by gas or fluid. Transnational gas and oil companies nourish interest of scientific community to such mixtures. The concept of mixtures was applied to composite materials already at that time, when for other types of mixtures, suspensions, emulsions and others, accumulated a lot of theoretical and experimental facts.

Therefore, the first variant of the mixture model of elastic materials proposed by Green and Steel had not even a proper matter of elastic deformation name **the diffusional model**. The point is that the hypothesis on diffusional character of the transmission of force pulse from one phase to other phase (so called the force interphase interaction) is natural for the fluid saturated porous materials and is adopted for solid mixtures from there.

Unfortunately, authors of the diffusional model have not paid attention on some contradiction between the hypothesis of diffusivity and more global hypothesis of elasticity for deformation of mixture. The elasticity can't have as a consequence the energy attenuation, whereas the diffusional force pulse is directly proportional to a relative velocity of phases and, therefore, it introduces into the full energy some term testifying the energy scattering in an elastic material. This circumstance was the implicit cause of inadequateness of proposed diffusional model with observed effects in conventional composite materials. The diffusional model has gone the full cycle of evolution, and at present time is remembered very seldom.

Further reading

1. Atkin, RJ & Crain, RE 1976, 'Continuum theory of mixtures: basic theory and historical developments', *Quart. J. Mech. and Appl. Math.*, vol. 29, no. 2, pp. 209-244.
2. Bedford, A, Drumheller, DS & Sutherland, HJ 1976, 'On modelling the dynamics of composite materials', In: Ne mat-Nasser, S (ed), *Mechanics Today*, vol.3, Pergamon Press, New York, pp. 1-54.
3. Bedford, A & Drumheller, DS 1983, 'Theories of immiscible and structured mixtures', *Int. J. Eng. Sci.*, vol. 21, no. 8, pp. 863-960.
4. Bowen, PM 1976, 'Mixtures and EM Field Theories', In: *Continuum Physics, Vol III*, Eringen, AC (ed), Academic Press, New York, pp. 1-127.
5. Broutman, LJ & Krock, RH (ed) 1974-1975, *Composite Materials*, in 8 vols. Academic Press, New York.
6. Cattani, C & Rushchitsky, JJ 2007, *Wavelet and wave analysis as applied to materials with micro or nanostructure*. World Scientific, Singapore-London.
7. Lempriere, B 1969, 'On practicability of analyzing waves in composites by the theory of mixtures', Lockheed Palo Alto Research Laboratory, Report No LMSC-6-78-69-21, pp. 76-90.
8. McNiven, HD & Mengi, Y 1979, 'A mathematical model for the linear dynamic behavior of two-phase periodic materials', *Int. J. Solids Struct.*, vol. 15, no. 1, pp. 271-280.
9. McNiven, HD & Mengi, Y 1979, 'A mixture theory for elastic laminated composites', *Int. J. Solids Struct.*, vol. 15, no. 1, 281-302.
10. McNiven, HD & Mengi, Y 1979, 'Propagation of transient waves in elastic laminated composites', *Int. J. Solids Struct.*, vol. 15, no. 1, pp. 303-318.
11. Rushchitsky, JJ 1991, *Elements of the theory of mixtures*. Naukova Dumka, Kyiv. (in Russian)
12. Rushchitsky, JJ & Tsurpal, SI 1998, *Waves in Materials with the Microstructure*, SP Timoshenko Institute of Mechanics, Kiev. (in Ukrainian)
13. Rushchitsky, JJ 1999, 'Interaction of waves in solid mixtures', *App. Mech. Rev.*, vol. 52, no. 2, pp. 35-74.
14. Tiersten, TR & Jahanmir, M 1977, 'A theory of composites modeled as interpenetrating solid continua', *Arch. Rat. Mech. Anal.*, vol. 54, no. 2, pp. 153-163.

Questions

- 8.1. Which way for transition of the principle of energy continualization from the layered materials to the fibrous ones can you propose?
- 8.2. Which new parameters are introducing into description of elastic deformation process by the approaches of effective stiffness?
- 8.3. Show the geometrical interpretation of the vector-director.
- 8.4. Sketch the geometrical picture of the layered material and comment the corresponding Bedford-Stern substantiation of the shear force interaction.
- 8.5. Try to render the transition from the internal energy of the two-phase mixture to corresponding linear constitutive equations.
- 8.6. How many parameters of coupling contains the basic system of the theory of two-phase mixtures?

9 Elastic harmonic plane waves in mixtures

Structural model of mixtures of elastic materials. Elastic wave equations. Plane linear elastic harmonic waves. Examples

Consider waves within the framework of the structural model of elastic mixtures. Let start with the volume and shear elastic waves in the isotropic mixture.

The basic equations can be obtained by simplifying the system of general anisotropy, namely the equations of motion and constitutive equations. A similar simplification in the classical theory of elasticity gives the Lamé equations. In the elastic mixture theory, the system is reduced to two coupled vector equations, which can be meant as some kind of generalization of the classical Lamé equations

$$\begin{aligned} & \mu_\alpha \Delta \vec{u}^{(\alpha)} + (\lambda_\alpha + \mu_\alpha) \text{grad div } \vec{u}^{(\alpha)} + \mu_\delta \Delta \vec{u}^{(\delta)} + (\lambda_\delta + \mu_\delta) \text{grad div } \vec{u}^{(\delta)} + \beta (\vec{u}^{(\delta)} - \vec{u}^{(\alpha)}) = \\ & = (\rho_{\alpha\alpha} - \rho_{12}) \ddot{\vec{u}}^{(\alpha)} + \rho_{12} \ddot{\vec{u}}^{(\delta)} \quad (\alpha, \delta = 1, 2; \alpha + \delta = 3). \end{aligned} \quad (9.1)$$

Please click the advert

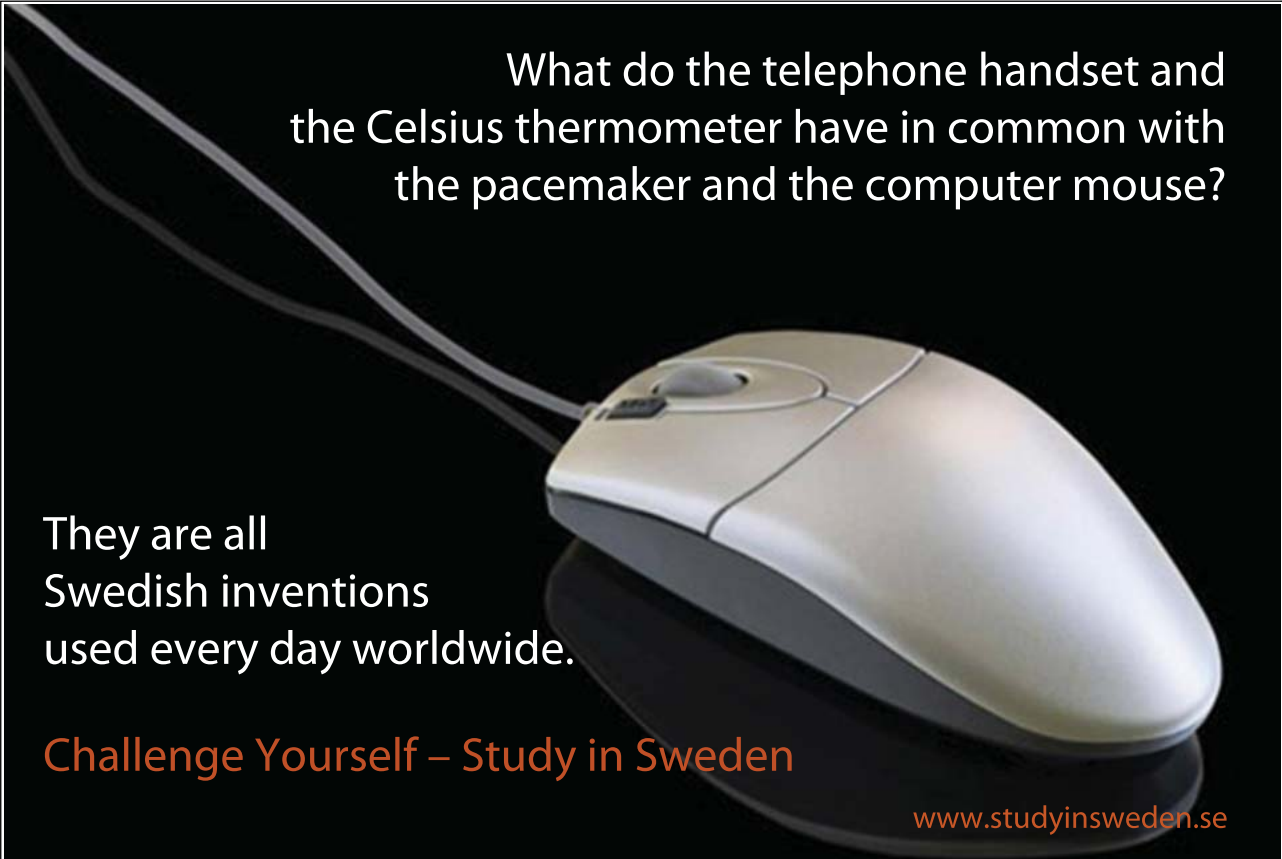

What do the telephone handset and the Celsius thermometer have in common with the pacemaker and the computer mouse?

They are all Swedish inventions used every day worldwide.

Challenge Yourself – Study in Sweden

www.studyinsweden.se

Download free ebooks at bookboon.com

The constitutive equations for isotropic elastic mixtures are as follows

$$\sigma_{ik}^{(\alpha)} = \lambda_{\alpha} \varepsilon_{mm}^{(\alpha)} \delta_{ik} + 2\mu_{\alpha} \varepsilon_{ik}^{(\alpha)} + \lambda_3 \varepsilon_{mm}^{(\delta)} \delta_{ik} + 2\mu_3 \varepsilon_{ik}^{(\delta)}. \quad (9.2)$$

The equations (9.2) contain six elastic constants λ_k, μ_k . Moreover, four mechanical constants are involved in equations (9.1): the densities $\rho_{11}, \rho_{22}, \rho_{12}$ and one constant β of interaction between phases of the mixture.

Thus, the isotropic mixture is characterized by ten constants altogether.

Let us apply to (9.1) the classical procedure of separation of the motion into two independent motions, one linked with the volume change, and other with the form change. For this purpose, represent vectors $\vec{u}^{(\alpha)}$ in the form

$$\vec{u}^{(\alpha)} = \vec{v}^{(\alpha)} + \vec{w}^{(\alpha)} \quad (\text{rot } \vec{v}^{(\alpha)} = 0, \text{div } \vec{w}^{(\alpha)} = 0).$$

As a result, two uncoupled systems of equations can be obtained

$$(\lambda_{\alpha} + 2\mu_{\alpha}) \Delta \vec{v}^{(\alpha)} + (\lambda_3 + 2\mu_3) \Delta \vec{v}^{(\delta)} + \beta (\vec{v}^{(\alpha)} - \vec{v}^{(\delta)}) = (\rho_{\alpha\alpha} - \rho_{12}) \frac{\partial^2 \vec{v}^{(\alpha)}}{\partial t^2} + \rho_{12} \frac{\partial^2 \vec{v}^{(\delta)}}{\partial t^2}, \quad (9.3)$$

$$\mu_{\alpha} \Delta \vec{w}^{(\alpha)} + \mu_3 \Delta \vec{w}^{(\delta)} + \beta (\vec{w}^{(\alpha)} - \vec{w}^{(\delta)}) = (\rho_{\alpha\alpha} - \rho_{12}) \frac{\partial^2 \vec{w}^{(\alpha)}}{\partial t^2} + \rho_{12} \frac{\partial^2 \vec{w}^{(\delta)}}{\partial t^2}. \quad (9.4)$$

Thus (9.1) is divided into two similar and simple uncoupled systems describing separately the propagation of volume waves and shear waves.

Consider the system

$$a_{\alpha} \Delta \vec{\varphi}^{(\alpha)} + a_3 \Delta \vec{\varphi}^{(\delta)} + \beta (\vec{\varphi}^{(\alpha)} - \vec{\varphi}^{(\delta)}) = (\rho_{\alpha\alpha} - \rho_{12}) \frac{\partial^2 \vec{\varphi}^{(\alpha)}}{\partial t^2} + \rho_{12} \frac{\partial^2 \vec{\varphi}^{(\delta)}}{\partial t^2}, \quad (9.5)$$

which can take the form of system (9.3) or system (9.4) depending on the coefficients a_k .

Assume the processes change harmonically with time $\vec{\varphi}^{(\alpha)}(x, t) = \vec{\varphi}^{(\alpha)}(x) e^{i\omega t}$, ($x \equiv (x_1, x_2, x_3)$) so that system (9.5) becomes

$$\left[a_{\alpha} \Delta - (\rho_{\alpha\alpha} - \rho_{12}) \omega^2 - \beta \right] \vec{\varphi}^{(\alpha)} + \left[a_3 \Delta - \rho_{12} \omega^2 + \beta \right] \vec{\varphi}^{(\delta)} = 0.$$

The solution of this homogeneous system of algebraic equations can be obtained as a sum of two functions, each of which describes a separate wave motion. That is, the motion is a superposition of two waves. There will be two volume waves for system (9.3) and two shear waves for (9.4).

To prove this separation, transform (9.5) into

$$\Delta \vec{\varphi}^{(1)} = \tilde{n}_{11} \vec{\varphi}^{(1)} + \tilde{n}_{12} \vec{\varphi}^{(2)}, \quad \Delta \vec{\varphi}^{(2)} = \tilde{n}_{21} \vec{\varphi}^{(1)} + \tilde{n}_{22} \vec{\varphi}^{(2)},$$

$$\tilde{n}_{\alpha\alpha} = m_\alpha \tilde{a}_\delta - m_3 \tilde{a}_3, \quad n_{\alpha\delta} = m_3 \tilde{a}_\delta - m_\alpha \tilde{a}_3, \quad \tilde{a}_k = \frac{a_k}{a_1 a_2 - a_3^2}, \quad a_1 a_2 - a_3^2 \neq 0,$$

$$m_\alpha = (\rho_{\alpha\alpha} - \rho_{12}) \omega^2 + \beta, \quad m_3 = \rho_{12} \omega^2 - \beta.$$

The solution of last system can be written as

$$\vec{\varphi}^{(\alpha)} = \vec{\psi}^{(\alpha)} + r_\delta(\omega) \vec{\psi}^{(\delta)}, \quad (9.6)$$

where $\vec{\psi}^{(\alpha)}$ is the solution of Helmholtz equation

$$\Delta \vec{\psi}^{(\alpha)} + l_\alpha^2 \vec{\psi}^{(\alpha)} = 0, \quad (9.7)$$

and l_α are the roots of the biquadratic equation

$$\begin{aligned} & (a_1 a_2 - a_3^2) l^4 - \left[(a_1 \rho_{22} + a_2 \rho_{11}) \omega^2 - (a_1 + a_2 + 2a_3) (\rho_{12} \omega^2 + \beta) \right] l^2 + \\ & + \left[\rho_{11} \rho_{22} \omega^2 - (\rho_{11} + \rho_{22}) (\rho_{12} \omega^2 + \beta) \right] \omega^2 = 0, \\ & r_\alpha = - \left(\frac{a_3 l_\alpha^2 - \beta - \rho_{12} \omega^2}{a_1 l_\alpha^2 + \beta - (\rho_{\alpha\alpha} - \rho_{12}) \omega^2} \right)^{(-1)\alpha}. \end{aligned}$$

Because basic system (9.5) describes all the waves in linearly elastic two-phase mixtures, then one can expect that the number of any type waves in the mixtures will double in comparison with a classical elastic medium.

The most essential feature of representation (9.6) isn't concerned with the number of waves, but with new wave properties.

**These waves will always be dispersive, because the coefficients
in Helmholtz equation (9.7) depend essentially on frequency.**

Let us check the ability of the model on the plane elastic harmonic waves.

The definition of plane waves in the structural approach is similar to the classical one. But in the mixture, the motion is already described by two displacement vectors, each phase of mixture has its own vector. In the plane wave, these vectors are not necessary collinear. However, the plane front of wave should be the same for both vectors. The representation of the plane wave is therefore as follows

$$\vec{u}^{(\alpha)}(x, t) = \vec{u}^{o(\alpha)} e^{i(\xi - \omega t)}. \quad (9.8)$$

Here $\vec{u}^{o(\alpha)}$ are arbitrary constant vectors; $\xi = \vec{k} \cdot \vec{r}$; \vec{r} is the radius-vector of the point $x \equiv (x_1, x_2, x_3)$

By using the general definition of plane motion in the basic motion equations of anisotropic mixture discussed in prior chapter the equations can be obtained

$$k^2 \left(c_{iklm}^{(\alpha)} \frac{\partial^2 u_m^{(\alpha)}}{\partial \xi^2} + c_{iklm}^{(3)} \frac{\partial^2 u_m^{(\delta)}}{\partial \xi^2} \right) n_k n_l + \beta_i (u_i^{(\alpha)} - u_i^{(\delta)}) = (\rho_{\alpha\alpha} - \rho_{12}) \frac{\partial^2 u_i^{(\alpha)}}{\partial t^2} + \rho_{12} \frac{\partial^2 u_i^{(\delta)}}{\partial t^2}. \quad (9.9)$$

They describe the plane motion, including the propagation of plane waves.

From (9.9) by substituting (9.8) the system of equations for phase velocities follows

$$\left\{ c_{iklm}^{(\alpha)} n_k n_l \frac{k^2}{\omega^2} - \left[(\rho_{\alpha\alpha} - \rho_{12}) + \frac{\beta_i}{\omega^2} \right] \delta_{im} \right\} u_m^{o(\alpha)} + \left\{ c_{iklm}^{(3)} n_k n_l \frac{k^2}{\omega^2} + \left(\frac{\beta_i}{\omega^2} - \rho_{12} \right) \delta_{im} \right\} u_m^{o(\delta)} = 0, \quad (9.10)$$

which can be meant as the direct generalization of classical Christoffel equation to the case of two-phase mixtures.

To analyze system (9.10), first some special important cases of symmetry in mixtures should be now outlined.

Definition 9.1. Define the isotropic, transversal-isotropic, and orthotropic mixtures as such media, for which three matrixes of elastic properties $c_{iklm}^{(n)}$ have the same necessary orders of symmetry (isotropic, transversal-isotropic, and orthotropic). Then from the particular representation of system (9.10) one can draw for each type of symmetry the corresponding types and numbers of waves.

In the isotropic mixture, there exist two modes of longitudinal waves (P -waves), horizontally polarized transverse waves (SH -waves), and vertically polarized transverse waves (SV -waves).

In the transversal-isotropic mixture, each wave have also two modes: three waves in the direction of symmetry axis, the longitudinal wave and two differently polarized and identical by velocities transverse waves, and three waves in the symmetry plane, P -wave, SH -wave, and SV -wave.

In the orthotropic mixture, two modes of nine wave types occur: threes waves (P, SH, SV) in the direction of each of the three axes of symmetry.

Focus now on **the characteristic example of the plane waves in isotropic mixture**.

Let us assume that the wave propagates in the direction of coordinate axis Ox_1 . In this case, the partial displacement vectors $\vec{u}^{(\alpha)}$ depend only on two variables

$$\vec{u}^{(\alpha)} \equiv \{ u_k^{(\alpha)}(x_1, t) \}. \quad (9.11)$$

By the substitution of (9.11) into (9.1) we get three uncoupled systems

$$(\rho_{\alpha\alpha} - \rho_{12}) \frac{\partial^2 u_1^{(\alpha)}}{\partial t^2} + \rho_{12} \frac{\partial^2 u_1^{(\delta)}}{\partial t^2} - (\lambda_\alpha + 2\mu_\alpha) \frac{\partial^2 u_1^{(\alpha)}}{\partial x_1^2} - (\lambda_3 + 2\mu_3) \frac{\partial^2 u_1^{(\delta)}}{\partial x_1^2} - \beta (u_1^{(\alpha)} - u_1^{(\delta)}) = 0, \quad (9.12)$$

$$(\rho_{\alpha\alpha} - \rho_{12}) \frac{\partial^2 u_m^{(\alpha)}}{\partial t^2} + \rho_{12} \frac{\partial^2 u_m^{(\delta)}}{\partial t^2} - \mu_\alpha \frac{\partial^2 u_m^{(\alpha)}}{\partial x_1^2} - \mu_\delta \frac{\partial^2 u_m^{(\delta)}}{\partial x_1^2} - \beta(u_m^{(\alpha)} - u_m^{(\delta)}) = 0 \quad (m = 2, 3). \quad (9.13)$$

Each of systems (9.12), (9.13) is coupled separately and, as expected, each of them describes the independent propagation of three types of waves – longitudinal, transverse horizontal, and transverse vertical ones.

The systems (9.12), (9.13) can be written in a form which is invariant with respect to the wave type

$$(\rho_{\alpha\alpha} - \rho_{12}) \frac{\partial^2 u_m^{(\alpha)}}{\partial t^2} + \rho_{12} \frac{\partial^2 u_m^{(\delta)}}{\partial t^2} - a_\alpha^{(k)} \frac{\partial^2 u_k^{(\alpha)}}{\partial x_1^2} - a_\delta^{(k)} \frac{\partial^2 u_k^{(\delta)}}{\partial x_1^2} - \beta(u_k^{(\alpha)} - u_k^{(\delta)}) = 0,$$

$$(a_m^{(1)} = \lambda_m + 2\mu_m, \quad a_m^{(2)} = a_m^{(3)} = \mu_m).$$

The last system has a solution in the form of harmonic waves

$$u_m^{(\alpha)}(x_1, t) = A_{om}^{(\alpha)} e^{-i(k_\alpha^{(m)} x - \omega t)} + l(k_\delta^{(m)}) A_{om}^{(\delta)} e^{-i(k_\delta^{(m)} x - \omega t)}. \quad (9.14)$$

Please click the advert

RedStarResume.

Do you want your Dream Job?

More customers get their dream job by using RedStarResume than any other resume service.

RedStarResume can help you with your job application and CV.

Go to: Redstarresume.com

Use code “BOOKBOON” and save up to \$15

(enter the discount code in the “Discount Code Box”)



The wave numbers $k_\alpha^{(m)}$ are determining from the dispersion equation

$$M_1^{(m)}k^4 - 2M_2^{(m)}k^2\omega^2 + M_3^{(m)}\omega^4 = 0,$$

$$M_1^{(m)} = a_1^{(m)}a_2^{(m)} - (a_3^{(m)})^2; \quad 2M_2^{(m)} = a_1^{(m)}\rho_{11} + a_2^{(m)}\rho_{22} - (a_1^{(m)} + a_2^{(m)} + 2a_3^{(m)})\left(\frac{\beta}{\omega^2} + \rho_{12}\right),$$

$$M_3^{(m)} = \rho_{11}\rho_{22} - (\rho_{11} + \rho_{22})\left(\frac{\beta}{\omega^2} + \rho_{12}\right),$$

and the coefficients $l(k_\alpha^{(m)})$ are determining by a simple algebraic formula

$$l(k_\alpha^{(m)}) = \left[\frac{a_\alpha^{(m)}(k_\alpha^{(m)})^2 + \beta - \rho_{\alpha\alpha}\omega^2}{a_3^{(m)}(k_\alpha^{(m)})^2 - \beta} \right]^{(-1)^\alpha}. \quad (9.15)$$

The main features of waves (9.14) are as follows:

- F1. There exist two simultaneous modes distinguishing by the wave numbers $k_\alpha^{(m)}$ (α fixes the number of a mode, while m characterizes the wave type).
- F2. Both modes are essentially dispersive waves.
- F3. Mixture filters one of the modes, it is cut off for low frequencies, leading off the frequency $\omega_{cut}^* = \sqrt{\beta(\rho_{11} + \rho_{22}) / \rho_{11}\rho_{22}}$, which is called **the cut off frequency**.
- F4. Two modes propagate in each phase and with their amplitudes; the amplitudes depend essentially nonlinearly on frequency; as a consequence the energy of modes is pumped from a mode to a mode with changing of frequency.

Note 9.1. All the above described effects (especially, the wave dispersion effect) have a structural character and the waves are linear. If to assume the dispersion in materials can be constructional, geometrical and viscoelastic, then one observed in mixtures is geometrical one.

Note that if the first longitudinal or transverse mode is chosen, it propagates in both phases of the mixture. Let us show it on the longitudinal wave.

In the first phase of a mixture **the first mode** propagates with arbitrary amplitude (according to definition of the running wave)

$$u_1^{(1)}(x_1, t) = A_{o1}^{(1)} e^{-i(k_1^{(1)}x - \omega t)}, \quad (9.16)$$

and in the second phase of a mixture **the same mode** propagates, but with amplitude correction by a special amplitude coefficient (9.15)

$$u_1^{(2)}(x_1, t) = l(k_1^{(2)})u_1^{(1)}(x_1, t). \quad (9.17)$$

If, instead, **the second mode** is chosen, it propagates in the first phase of a mixture as

$$u_2^{(1)}(x_1, t) = l(k_1^{(1)})u_2^{(2)}(x_1, t), \quad (9.18)$$

while in the second phase of a mixture, the mode will propagate

$$u_2^{(2)}(x_1, t) = A_{o1}^{(2)} e^{-i(k_1^{(2)}x_1 - \omega t)}, \quad (9.19)$$

amplitude of which is the second independent arbitrary amplitude. Thus, four waves in the mixtures are characterized by two independent amplitudes.

Fig.9.1 and Fig.9.2 show the typical dispersion curves for the first and second modes of transverse plane harmonic wave evaluated for the fibrous composites of internal structure of microlevel (matrix - epoxide rosin EPON -828 and fillers - microwhiskers) for two variants of volume fraction of fillers 0.1 and 0.2. The unit on the abscissa axis corresponds to the frequency in 10 MHz and on the ordinate axis corresponds to the phase velocity in 1 km/s .

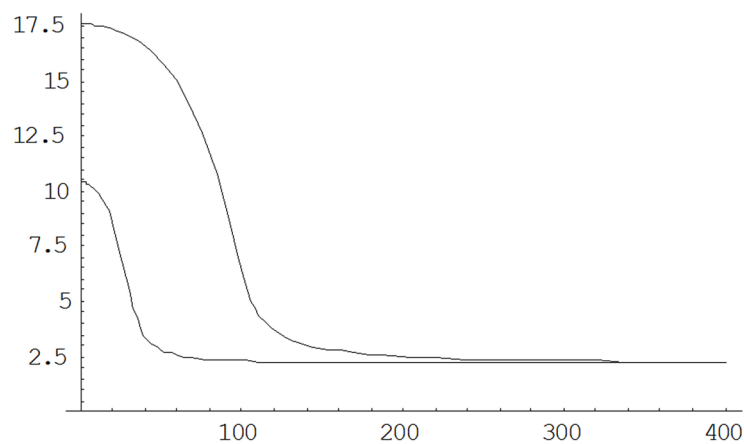

Fig.9.1. Dispersion curves "phase velocity via frequency" for the first mode

The horizontal asymptotes on both figures correspond to limit values of the phase velocity for high frequencies.

It can be seen from Fig.9.1 and Fig. 9.2 that the first mode is essentially slower than the second mode, which can be named as the fast mode. Two imaginary vertical asymptotes for the left side of lines on Fig.9.2 correspond to values of cut-off frequencies.

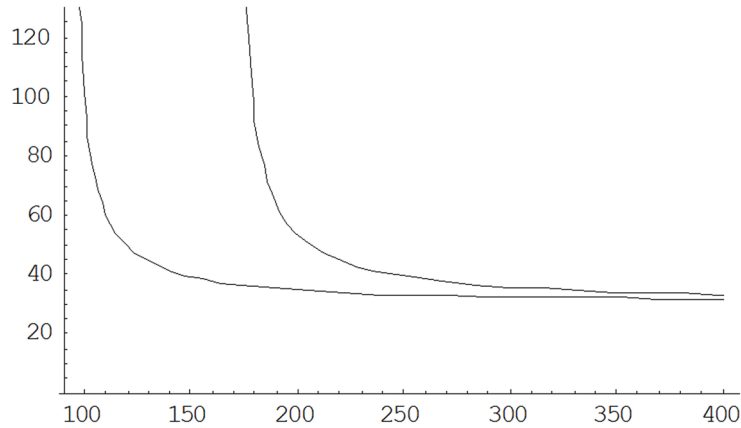

Fig.9.2. Dispersion curves “phase velocity via frequency” for the second mode

Fig.9.3 shows the typical spatial picture “amplitude-time-spatial coordinate” for the fibrous material (matrix from the epoxide rosin and fillers from microfibers Thornel-300 with volume fraction 0.2). The unit on abscissa, ordinate and applicative axes corresponds to the unit amplitude, the time in μS , the spatial coordinate in microns, respectively.

Please click the advert

Brain power



By 2020, wind could provide one-tenth of our planet's electricity needs. Already today, SKF's innovative know-how is crucial to running a large proportion of the world's wind turbines.

Up to 25 % of the generating costs relate to maintenance. These can be reduced dramatically thanks to our systems for on-line condition monitoring and automatic lubrication. We help make it more economical to create cleaner, cheaper energy out of thin air.

By sharing our experience, expertise, and creativity, industries can boost performance beyond expectations. Therefore we need the best employees who can meet this challenge!

The Power of Knowledge Engineering

Plug into The Power of Knowledge Engineering.
Visit us at www.skf.com/knowledge



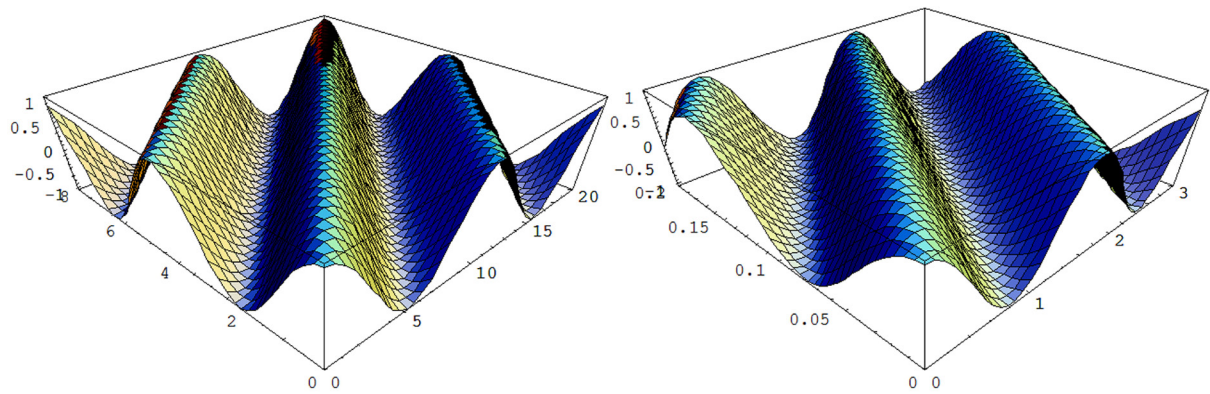

Fig.9.3. The wave picture in coordinates "amplitude-time-spatial coordinate"

The first picture corresponds to the first (slow) mode and the second one corresponds to the second (fast) mode. The different slopes of the wave picture to the time axis reflects the different phase velocities of the 1st and 2nd modes. The unit of spatial coordinate is 1 micron in both pictures, the unit of time is 1 microsecond and 0.1 microsecond for the 1st and 2nd modes, respectively.

The characteristic view of coefficients $l(k_1^{(1)}, \omega)$ and $l(k_1^{(2)}, \omega)$ depending on frequency can be seen in Fig.9.4 and Fig.9.5 for fibrous materials (the composite with volume fraction 0.2 of microfibers Thornel-300 and nanofibers in the form of zigzag nanotubes, respectively).

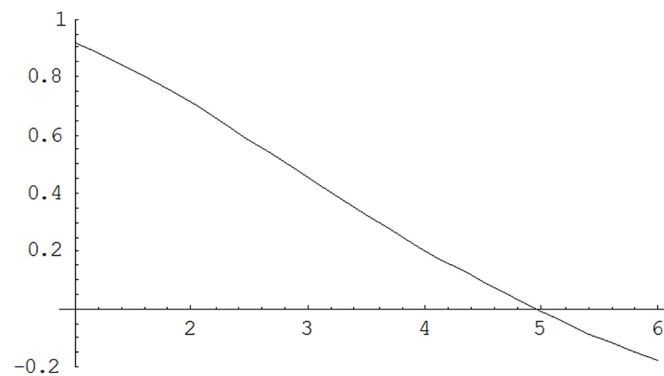

Fig.9.4. Plots of coefficients $l(k_1^{(1)}, \omega)$ and $l(k_1^{(2)}, \omega)$ for the microcomposite

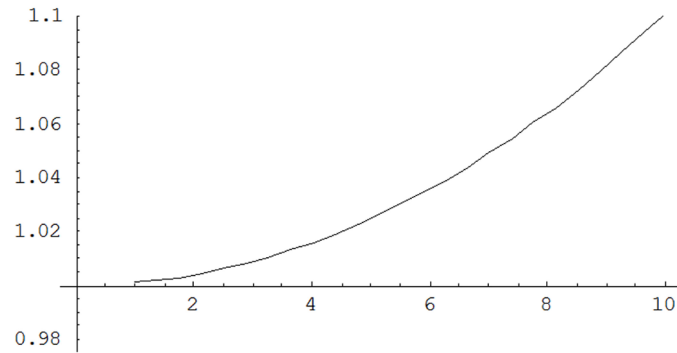

Fig.9.5. Plots of coefficients $l(k_1^{(1)}, \omega)$ and $l(k_1^{(2)}, \omega)$ for the nanocomposite

The unit on abscissa axis on Fig.9.4 and Fig.9.5 corresponds to different values of frequency, namely 100 MHz and 100 GHz, respectively.

The last question to be discussed in the chapter-lecture is associated with experiments with plane waves in mixtures. The only materials, experiments with which were thorough and extensive are the composite ones. Therefore the wave dispersion as one of the most studied wave phenomena was studied well.

Note 9.2. The prevailing point of view consists in that any observation of wave phenomena in tests with real materials should be concentrated on some chosen phenomena and the description or the setting of this observation is based on some theoretical scheme. The theory defines what should be observed.

Note 9.3. When being wished to observe certain wave phenomenon, it turned out to find (very difficult and very often) the real material in which this phenomenon will be shown isolated. The real wave picture is always more complicated as it is described in the theoretical scheme. This becomes apparent when we study the wave dispersion in composite materials. In experiments with plane and volume waves, the dispersion of different nature – geometrical, viscoelastic, and constructional – seems to much difficult for separation.

Definition 9.2. The geometrical dispersion in materials is called the dispersion which arises owing to presence in materials both of the internal structure and interaction of waves with elements of the structure.

Definition 9.3. The viscoelastic dispersion in composite materials is usually the effect of the viscoelastic properties of the matrix of composites.

The geometrical dispersion decreases always the phase velocity for increasing frequency, whereas the viscoelastic dispersion, vice versa, increases the phase velocity.

Definition 9.4. The constructional dispersion arises when waves interact with the boundary surfaces of constructions.

Note 9.4. The wave length as a parameter, which determines the bounds of applicability of all theoretical schemes of wave propagation, plays the special role. As a consequence, the wave length range (the frequency range), with which the experiments were realized, is very essential in experiments.

Comments

It is necessary to pay attention to two features of plane wave phase velocities in the mixtures.

The first consists in that the phase velocities of both modes tend for high frequencies to some finite values.

The second testifies a link of the mixture theory as the structural theory of the second order with the effective moduli theory as the structural theory of the first order. The question is that at the small frequencies (consequently, at the large wave lengths) the phase velocity of the first mode tends to be the value of the phase velocity given by formulas of the effective moduli theory.

The next comment is associated with Fig.9.4 and Fig.9.5. The common for all four waves feature of behaviour consists in that the first (slow – with the usual for materials phase velocity) propagates in both components independently with amplitudes $u_1^{(1)o}$ (in the first component – fiber) and $l(k_1^{(1)}, \omega)u_1^{(1)o}$ (in the second component – matrix) and the second mode (fast – with significantly more phase velocity) propagates simultaneously with the first mode in both components with amplitudes $l(k_1^{(1)}, \omega)u_1^{(2)o}$ (in the first component – fiber) and $u_1^{(2)o}$ (in the second component – matrix).

As it follows from plots, the quantity $l(k_1^{(1)}, \omega)$ is always positive one. Hence, the oscillations of particles of fibers and matrix are always in-phase when the first mode being propagated.

The quantity $l(k_1^{(2)}, \omega)$ is first positive (starting with the cut-off frequency equal to $\omega_{cut} = 354 \text{ MHz}$ for the micromaterial and $\omega_{cut} = 290,3 \text{ GHz}$ for the nanomaterial. Further it changes the sign and becomes negative ($\omega_{crit} = 500 \text{ MHz}$ for the micro material and $\omega_{crit} = 750 \text{ GHz}$ for the nanomaterial). Therefore, for all the frequencies more than ω_{crit} , the oscillations of particles of fibers and matrix occur anti-phase.

This fact can be meant as one of mechanisms of debonding of composite materials.

Finally it is worthy to note that the homogenization of internal structure of composite materials, which is realized in the mixture models, reduces to that the very complicate picture of wave propagation accompanying by wave reflections, refractions, diffractions et cetera, is averaged and “in herba latet” displaying the averaged property of the wave motion as geometrical dispersion.

Further reading

1. Bedford, A & Sutherland, HJ 1973, 'A lattice model for stress wave propagation in composite materials,' *Trans. ASME. J. Appl. Mech.*, vol. 40, no. 1, pp. 157-164.
2. Bedford, A, Drumheller, DS & Sutherland, HJ 1976, 'On modelling the dynamics of composite materials,' In: Nemat-Nasser, S (ed), *Mechanics Today.*, vol.3, Pergamon Press, New York, pp. 1-54.
3. Bedford, A & Drumheller, DS 1983, 'Theories of immiscible and structured mixtures,' *Int. J. Eng. Sci.*, vol. 21, no. 8, pp. 863-960.
4. Ben-Amoz, M 1975, 'On wave propagation in laminated composites. - I. Propagation parallel to the laminates,' *Int. J. Engng. Sci.*, vol. 14, no. 1, pp. 43-56.
5. Ben-Amoz, M 1975, 'On wave propagation in laminated composites. - II. Propagation normal to the laminates,' *Int. J. Engng. Sci.*, vol. 14, no. 1, pp. 57-67.
6. Bowen, PM 1976, 'Mixtures and EM Field Theories,' In: *Continuum Physics, Vol III*, Eringen, AC (ed), Academic Press, New York, , pp. 1-127.
7. Cattani, C & Rushchitsky, JJ 2007, *Wavelet and wave analysis as applied to materials with micro or nanostructure*. World Scientific, Singapore-London.
8. Drumheller, DS & Bedford, A 1974, 'Wave propagation in elastic laminates using a second order microstructure theory,' *Int. J. Solids Struct.*, Vol. 10, no. 10, pp. 61-76.
9. Hegemier, GA & Nayfeh, AN 1973, 'A continuum theory for wave propagation in composites.- Case 1: propagation normal to the laminate,' *Trans. ASME. J. of Appl. Mech.*, vol. 40, no. 2, pp. 503-510.
10. Hegemier, GA & Bache, TC 1973, 'A continuum theory for wave propagation in composites.- Case 2: propagation parallel the laminates,' *J. of Elasticity*, vol. 3, no. 2, pp. 125-140.

Trust and responsibility

NNE and Pharmaplan have joined forces to create NNE Pharmaplan, the world's leading engineering and consultancy company focused entirely on the pharma and biotech industries.

Inés Aréizaga Esteva (Spain), 25 years old
Education: Chemical Engineer

– You have to be proactive and open-minded as a newcomer and make it clear to your colleagues what you are able to cope. The pharmaceutical field is new to me. But busy as they are, most of my colleagues find the time to teach me, and they also trust me. Even though it was a bit hard at first, I can feel over time that I am beginning to be taken seriously and that my contribution is appreciated.

Please click the advert



NNE Pharmaplan is the world's leading engineering and consultancy company focused entirely on the pharma and biotech industries. We employ more than 1500 people worldwide and offer global reach and local knowledge along with our all-encompassing list of services.

nnepharmaplan.com

nne pharmaplan®

11. Hegemier, GA & Bache, TC 1974, 'A general continuum theory with the microstructure for the wave propagation in elastic laminated composites', *Trans. ASME. J. of Appl. Mech.*, vol. 41, no. 1, pp. 101-105.
12. Herrmann, G, Kaul, RK & Delph, TG 1978, 'On continuum modelling of the dynamic behaviour of layered composites', *Archives of Mechanics*, vol. 28, no. 3, pp. 405-421.
13. McNiven, HD & Mengi, Y 1979, 'A mathematical model for the linear dynamic behavior of two-phase periodic materials', *Int. J. Solids Struct.*, vol. 15, no. 1, pp. 271-280.
14. McNiven, HD & Mengi, Y. 1979, 'A mixture theory for elastic laminated composites', *Int. J. Solids Struct.*, vol. 15, no. 1, 281-302.
15. McNiven, HD & Mengi, Y 1979, 'Propagation of transient waves in elastic laminated composites', *Int. J. Solids Struct.*, vol. 15, no. 1, pp. 303-318.
16. Rushchitsky, JJ 1974, 'To the plane problem of theory of mixture of two solids', *Soviet Appl. Mech.*, vol. 10, no. 2, pp.52-61.
17. Rushchitsky, JJ 1978, 'On certain case of wave propagation in the mixture of elastic materials', *Soviet Appl. Mech.*, vol. 14, no. 1, pp.25-33.
18. Rushchitsky, JJ 1979, 'Determination of physical constants of the theory of mixture of elastic materials using the experimentally obtained dispersion curves', *Int. Appl. Mech.*, vol. 15, no. 6, pp. 26-32.
19. Rushchitsky, JJ 1991, *Elements of the theory of mixtures*. Naukova Dumka, Kyiv. (in Russian)
20. Rushchitsky, JJ & Tsurpal, SI 1998, *Waves in Materials with the Microstructure*. SP Timoshenko Institute of Mechanics, Kiev. (in Ukrainian)
21. Rushchitsky, JJ 1999, 'Interaction of waves in solid mixtures', *Appl. Mech. Rev.*, vol. 52, no. 2, pp. 35-74.
22. Sutherland, HJ 1979, 'Dispersion of acoustic waves by an alumina-epoxy mixture', *J. Compos. Mater.*, vol. 13, no. 1, pp. 35-47.

Questions

- 9.1. Show that the number of modes in the multi-component mixture is defined by the number of components. List the shear waves in the separately taken component of three-component mixture (three-component composite material) and indicate the total number of shear waves in the material.
- 9.2. How many independent amplitudes will be in the representation of plane longitudinal (transverse) wave propagating in the three-component mixture (three-component composite material)?
- 9.3. Can be predicted the situation when the second (fast) mode will be absent for the frequencies exceeding the cut-off frequency?
- 9.4. Explain the physical mechanism of wave dispersion in the elastic mixtures (elastic composite materials) and link with the term "geometrical dispersion".

10 Viscoelastic waves. Basic models

Basic models. Boltzmann principle. The simplest rheological models: Maxwell model, Voigt model, Poynting-Thomson and Kelvin models. Relaxation time and retardation time.

It seems to be relevant to study the models of materials manifesting simultaneously the properties of elasticity and viscosity as well as the waves in such materials immediately after the models of elastic deformation and analysis of elastic waves.

If to assume that all the totality of elastic models forms a basis of the theory of elasticity, then the theory of viscoelasticity is correspondingly the most close to the theory of elasticity among other theories, such as the thermoelasticity, piezoelectricity et cetera.

The mentioned propinquity consists in that constructing the theory of viscoelasticity does not need of introducing some new physical field (for example, in the theory of thermoelasticity the temperature field must be introduced, in the theory of piezoelectricity – electromagnetic fields et cetera).

It can be considered that the main concept of the theory of viscoelasticity is based on the Boltzmann heredity principle and the mathematical apparatus developed about one hundred years ago by Volterra.

The feature of the Boltzmann principle is that the principle is applying to some group of the basic equations of the theory of elasticity only and is transforming in the end all the system into the basic equations of the theory of viscoelasticity. This group of equations is called the constitutive equations (or better to say the Hooke law or its generalizations).

Traditionally the constitutive equations in the theory of viscoelasticity are called the rheological equations.

So, the Boltzmann heredity principle is applied to create from the elastic Hooke law the new rheological equations. In the most general form, the Hooke law gives some nonlinear dependence between components of stress and strain tensors

$$\sigma_{ik} = f_{ik}(\varepsilon_{11}, \dots, \varepsilon_{31}), \quad \varepsilon_{ik} = f_{ik}(\sigma_{11}, \dots, \sigma_{31})$$

$$\text{or } \sigma(x, t) = f(\varepsilon(x, t)), \quad \varepsilon(x, t) = g(\sigma(x, t)).$$

Thus, this law links stresses at the given point and the given moment with strains at the same point and the same moment.

The Boltzmann heredity principle affirms that stresses at the given point and the given moment depend on all the history of changing the strains on interval $[0; t]$. It is said therefore that the materials has the memory and the stresses are a functional of strains. This dependence is denoted as follows

$$\sigma(x, t) = \overset{\tau=t}{\underset{\tau=0}{F}}(\varepsilon(x, \tau)), \quad \varepsilon(x, t) = \overset{\tau=t}{\underset{\tau=0}{G}}(\sigma(x, \tau))$$

Note 10.1. The term ‘hereditary’ can be understood as the fact that values of stresses at the given point and the given moment depend not only of values of strains at the given point and the given moment, but it is getting in the inheritance all the values of strains at the given point of the deformation process and it is forced to depend of them.

The second important component of the Boltzmann heredity principle is that the memory of values of strains at the prior moments is such that an influence of recent moments is more than an influence of the old ones and analytically this influence is described by the decreasing function.

This moment of the theory will be discussed more in detail, when the rheological equations in the form of Volterra integral equations will be studied.

Note 10.2. The most part of results in the theory of viscoelasticity is obtained for the linear functionals and hence for the linear theory.

The term ‘viscoelasticity’ can be explained by that the theory describes the phenomena of strain creep and stress relaxation as the manifestation of presence in the material of properties of elasticity and viscosity. This can be seen clearly from analysis of the simplest rheological models, which were historically the first ones and features of which had been influenced also on the theory name.

Consider briefly three most used among the simple models rheological models: the two-element Maxwell and Voigt models, the three-element Poynting-Thompson and Kelvin model.

Please click the advert

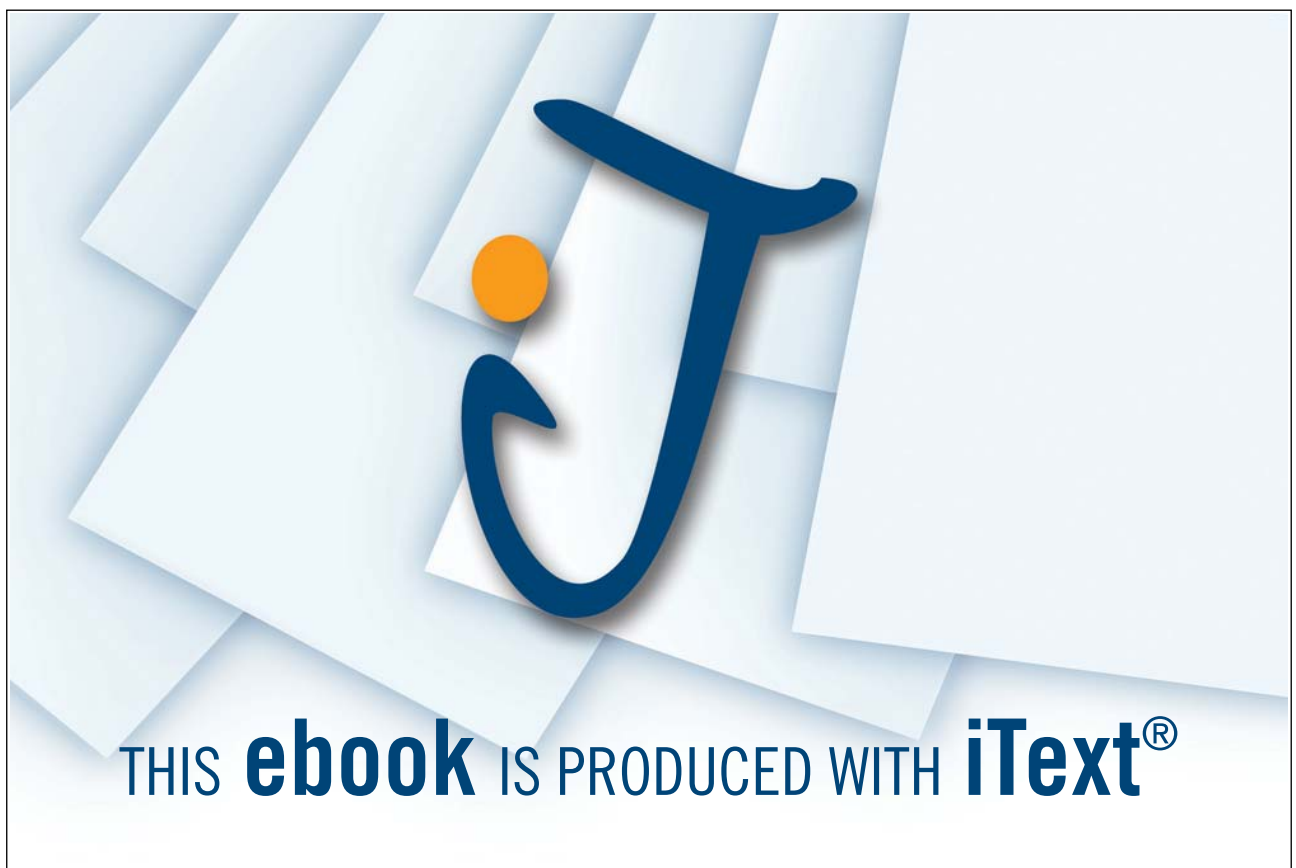

Download free ebooks at bookboon.com

Two elements are utilized in these models: the spring, which is deforming elastically and is denoted by H (from Hooke), and the piston, which is deformed viscously and is denoted by N (from Newton). The elements are arranged by a successive or parallel linking into the geometrical schemes, deformation of which is studied by the special approach developed long ago in rheology.

Being loaded (stretched) the elements are deformed and can be characterized by the stress and the strain - two basic mechanical characteristics. Both elements are deformed according to linear one-dimensional models: elastic body and viscous fluid, respectively. Each model has the classical description (see comment at the end of lecture).

Maxwell model

The rheological formula for two-element Maxwell model has the form $M = H-N$. The rheological scheme is shown on Fig.10.1.

Maxwell has been considered this model for exploring the nature of gases viscosity. The scheme is commented as follows: owing to the succession of linking the elements, the stress in elements will be identical

$$\sigma_H = \sigma_N = \sigma, \quad \sigma_H = 2\mu\epsilon_H, \quad \sigma_N = 2\eta\dot{\epsilon}_N.$$

The strain velocity at the point A , to which the tension force is applied, is equal to the sum of velocities in elements

$$\dot{\epsilon}_H = \frac{\dot{\sigma}_H}{2\mu}, \quad \dot{\epsilon}_N = \frac{\sigma_N}{2\eta}. \text{ Then } \dot{\epsilon}(t) = \dot{\epsilon}^{(A)} = \frac{\dot{\sigma}(t)}{2\mu} + \frac{\sigma(t)}{2\eta}. \quad (10.1)$$

This is the rheological equation for the Maxwell model.

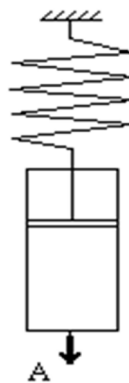

Fig.10.1. Maxwell model

It is the ordinary differential equation of the first order with constant coefficients relative to both functions $\sigma(t), \epsilon(t)$. Usually equation (10.1) is integrated with the condition of absence of stress and strain at the initial moment $\sigma(0) = 0, \epsilon(0) = 0$.

As a result, the representation for the stress and strain is obtained

$$\varepsilon(t) = \frac{1}{2\mu} \sigma(t) + \frac{\eta}{\mu} \int_0^t \sigma(\tau) d\tau$$

If to assume $\sigma(0) = \sigma_o$, $\varepsilon(0) = \varepsilon_o$, then $\sigma(t) = e^{-\frac{\mu}{\eta}t} \left[\sigma_o + 2\mu \int_0^t \dot{\varepsilon}(\tau) e^{\frac{\mu}{\eta}\tau} d\tau \right]$ or

$$\sigma(t) - \sigma_o = 2\mu \left[\varepsilon(t) - \varepsilon_o - \frac{\mu}{\eta} \int_0^t \varepsilon(\tau) e^{-\frac{\mu}{\eta}(t-\tau)} d\tau \right]. \quad (10.2)$$

As a rule, three particular cases are interesting because of possibility to characterize quite fully the ability of the model to describe the phenomena of stress relaxation and strain creep:

Case 1. $\varepsilon = const$. **Case 2.** $\sigma = const$. **Case 3.** $\sigma(t) = \sigma_o \sin \omega t$ or $\varepsilon(t) = \varepsilon_o \sin \omega t$.

Case 1. The equation (10.2) simplifies to $\sigma(t) = \sigma_o e^{-\frac{\mu}{\eta}t}$. Thus, the stress decreases by the exponential law from σ_o to zero, what corresponds to the classical definition of stress relaxation.

Definition 10.1. The time during of which the stress decreases e times, is called **the relaxation time**. In the Maxwell model, it has the form $\tau_{rel} = (\eta/\mu)$ and has the dimension of time ($[\mu] = Pa$), ($[\eta] = Pa \cdot s$)

Case 2. It is sufficient to consider equation (10.1), from which follows $\frac{\sigma}{2\eta} = \dot{\varepsilon} = const$. That is, in this case the material is flowing with the constant velocity like the Newton fluid.

Note 10.3. Thus the Maxwell model does not describe **the strain creep** and is in this sense the degenerated model.

Case 3. Consider equation (10.1) with taking into account that $\sigma(t) = \sigma_o \sin \omega t$. It will transform to the form $\dot{\varepsilon}(t) = \frac{1}{2\eta} \sigma_o \sin \omega t + \frac{\omega}{2\mu} \sigma_o \cos \omega t$. Let us solve this equation relative to $\varepsilon(t)$

$$\varepsilon(t) = -\frac{1}{2\eta\omega} \sigma_o \cos \omega t + \frac{1}{2\mu} \sigma_o \sin \omega t.$$

Denote $-\frac{\sigma_o}{2\eta\omega} = \varepsilon_o \cos \varphi$, $\frac{\sigma_o}{2\mu} = \varepsilon_o \sin \varphi$. Then the last equation will transform into

$$\varepsilon(t) = \varepsilon_o \sin(\omega t + \varphi).$$

Definition 10.2. It is said usually that ε_o is the amplitude of strain oscillations and φ is the angle of phase shift for strain oscillations relative to the stress oscillations. They are determined by the formulas

$$\varepsilon_o = \sqrt{\left(\frac{\sigma_o}{2\eta\omega}\right)^2 + \left(\frac{\sigma_o}{2\mu}\right)^2} = \frac{\sigma_o}{2\mu\eta\omega} \sqrt{\mu^2 + \eta^2\omega^2} = \frac{\sigma_o}{2\mu\omega\tau_{rel}} \sqrt{1 + (\tau_{rel})^2\omega^2}, \quad \tan\varphi = -\frac{\mu}{\eta\omega} = -\frac{1}{\omega\tau_{rel}}.$$

Note 10.4. When the frequency (or the relaxation time) being changed from zero to infinity, then the amplitude is changed from infinity to $\sigma_o/2\mu$ and the angle of phase shift is changed from $-\pi/2$ to zero. The angle of phase shift is always negative, what means that the stress change leaves behind the strain change always.

Finally, it is necessary to note that despite of the Maxwell model belongs to the simplest rheological models and has the methodological character, it qualitatively rightly reflects the most essential features of deformation of polymers when they being passed from the high-elasticity state to the viscous-flow state.

Voigt model

The rheological formula for two-element Voigt model has the form $F = H | N$. The rheological scheme is shown on Fig.10.2. For the first time this model was proposed as early as 1875 by Kelvin for explanation of attenuation phenomenon during gels oscillations.

Later in 1890-1892 Voigt has been described by the model a behaviour of one-phase media, which have been deformed as the solid.

As it follows from Fig. 10.2, the common force consists of the sum of forces in elastic and viscous elements.

Please click the advert

THE MILKWAY
LAUNCHING GRADUATE CAREERS

FIRST CONTACT
Get matched to top business employers via intelligent emails landing in your inbox.

MILKROUND SYSTEM
Become a business star with internships, placements, graduate jobs & schemes from leading companies.
www.milkround.com

PLANET CAREER ADVICE
Inhabited by insights into business careers and orbited by application advice.

Milkround.com: rated the #1 graduate recruitment website in the UK Graduate Careers Survey 2009 of 16,000 university finalists.

Milkround.com

Basing on this fact, the rheological equation is obtaining

$$\sigma(t) = 2\mu\varepsilon(t) + 2\eta\dot{\varepsilon}(t). \tag{10.3}$$

Relative to the function $\varepsilon(t)$, it is an ordinary differential equation of the first order with constant coefficients.

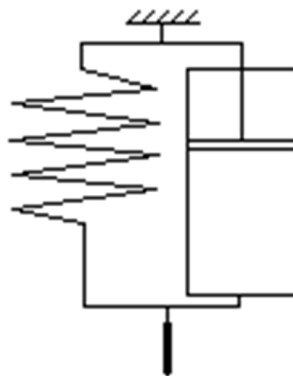

Fig.10.2. Voigt model

The solution of (10.3) for arbitrary function $\sigma(t)$ and with condition $\varepsilon(0) = \varepsilon_0$ is as follows

$$\varepsilon(t) = \left[\varepsilon_0 e^{-\frac{\mu}{\eta}t} + \frac{1}{2\eta} \int_0^t \sigma(\tau) e^{-\frac{\mu}{\eta}(t-\tau)} d\tau \right]. \tag{10.4}$$

Consider the same three cases as before for the Maxwell model.

Case 1. $\varepsilon = const$. It follows from equation (10.3) that $\sigma = 2\mu\varepsilon$. So, in this case the material manifests the elastic property only and the Voigt model doesn't describe the expected phenomenon of stress relaxation. The model is in this sense the degenerated model.

Case 2. $\sigma = const$. Let us integrate rheological equation (10.4) for the given condition $\sigma(t) = \sigma_0 = const$ and obtain

$$\varepsilon(t) = \frac{\sigma_0}{2\mu} \left[1 - e^{-\frac{\mu}{\eta}t} \right] = \frac{\sigma_0}{2\mu} \left[1 - e^{-\frac{t}{\tau_{rel}}} \right]. \tag{10.5}$$

The formula (10.5) shows that for $t \rightarrow \infty$ $e^{-\frac{t}{\tau_{rel}}} \rightarrow 0$ and the strain tends to its equilibrium state. Thus, the Voigt model foresees that for the long-time tests the material manifests the pure elastic behaviour.

Let us find the value of strain rate **for the constant loading**. For this purpose, the equation (10.5) should be differentiated

$$\dot{\varepsilon}(t) = (\sigma_o/2\eta) e^{-\frac{t}{\tau_{rel}}}. \quad (10.6)$$

If to assume the test duration to be small, then $e^{-\frac{t}{\tau_{rel}}} \approx 1$ and equation (10.6) becomes $\dot{\varepsilon}(t) = \frac{\sigma_o}{2\eta}$, from which follows that the Voigt model foresees for the short-time tests a behaviour of the material as the usual Newton fluid.

Note 10.5. Both last observations agree with the general principle of rheology that the behaviour of materials depends essentially on the test conditions.

Consider **the case, when loading is stopped at moment** $t = t_1$. During the time $t - t_1$ the strain will run to the value

$$\varepsilon(t_1) = \varepsilon_1 = \frac{\sigma_o}{2\mu} \left(1 - e^{-\frac{\mu}{\eta} t_1} \right). \quad (10.7)$$

This state is the initial one for next deformation without loading. The general solution of rheological equation (10.3) for $\sigma = 0$ with taking into account (10.7) is as follows

$$\varepsilon(t) = \varepsilon_1 e^{-\frac{\mu}{\eta}(t-t_1)} = \frac{\sigma_o}{2\mu} \left(1 - e^{-\frac{\mu}{\eta} t_1} \right) e^{-\frac{\mu}{\eta}(t-t_1)}.$$

Definition 10.3. The obtained formula shows that the strain after removal of the load will decrease depending on the quantity $\tau_{ret} = (\eta/\mu)$, which is called **the retardation time**.

The relaxation time and retardation time coincide for the Voigt model $\tau_{rel} = \tau_{ret}$, but in the general case they are not identical.

Case 3. $\sigma(t) = \sigma_o \sin \omega t$. The rheological equation (10.3) will have the form

$$\dot{\varepsilon}(t) + \frac{\mu}{\eta} \varepsilon(t) = \frac{\sigma_o}{2\eta} \sin \omega t.$$

Its solution is as follows

$$\varepsilon(t) = \frac{\sigma_o \mu}{2(\mu^2 + \eta^2 \omega^2)} \sin \omega t - \frac{\sigma_o \eta \omega}{2(\mu^2 + \eta^2 \omega^2)} \cos \omega t \quad \text{or} \quad \varepsilon(t) = \varepsilon_o \sin(\omega t + \varphi),$$

$$\text{where } \varepsilon_o = \frac{\sigma_o}{2(\mu^2 + \eta^2 \omega^2)}, \quad \tan \varphi = -\frac{\eta \omega}{\mu}.$$

Thus, while the frequency (the relaxation time) being changed from zero to infinity, the strain oscillations decay (the amplitude is changed from ε_0 to zero) and the angle of phase shift is changed from zero to $(-\pi/2)$. So, here like the Maxwell model the strain change retards from the stress change.

Poynting-Thomson and Kelvin models

These two models are mechanically equivalent and are distinguished by the rheological schemes and some notations. The Fig. 10.3 corresponds to the Poynting-Thomson model and Fig. 10.4 corresponds to the Kelvin model.

So, the Poynting-Thomson scheme consists of two parallel linked components: elastic element and Maxwell scheme $PhT = H \parallel M$.

The Kelvin scheme consists of the successively linked Voigt scheme and elastic element $K = V-H$.

Let us start with the **Poynting-Thomson model**. The initial relationships here are the next ones

$$\varepsilon = \varepsilon_H = \varepsilon_M, \quad \sigma = \sigma_H + \sigma_M,$$

$$\sigma_H = 2\mu_H \varepsilon, \quad \sigma_M(t) = e^{-\frac{\mu_M t}{\eta}} \left[\sigma_{oM} + 2\mu_M \int_0^t \dot{\varepsilon}(\tau) e^{\frac{\mu_M \tau}{\eta}} d\tau \right].$$

Please click the advert

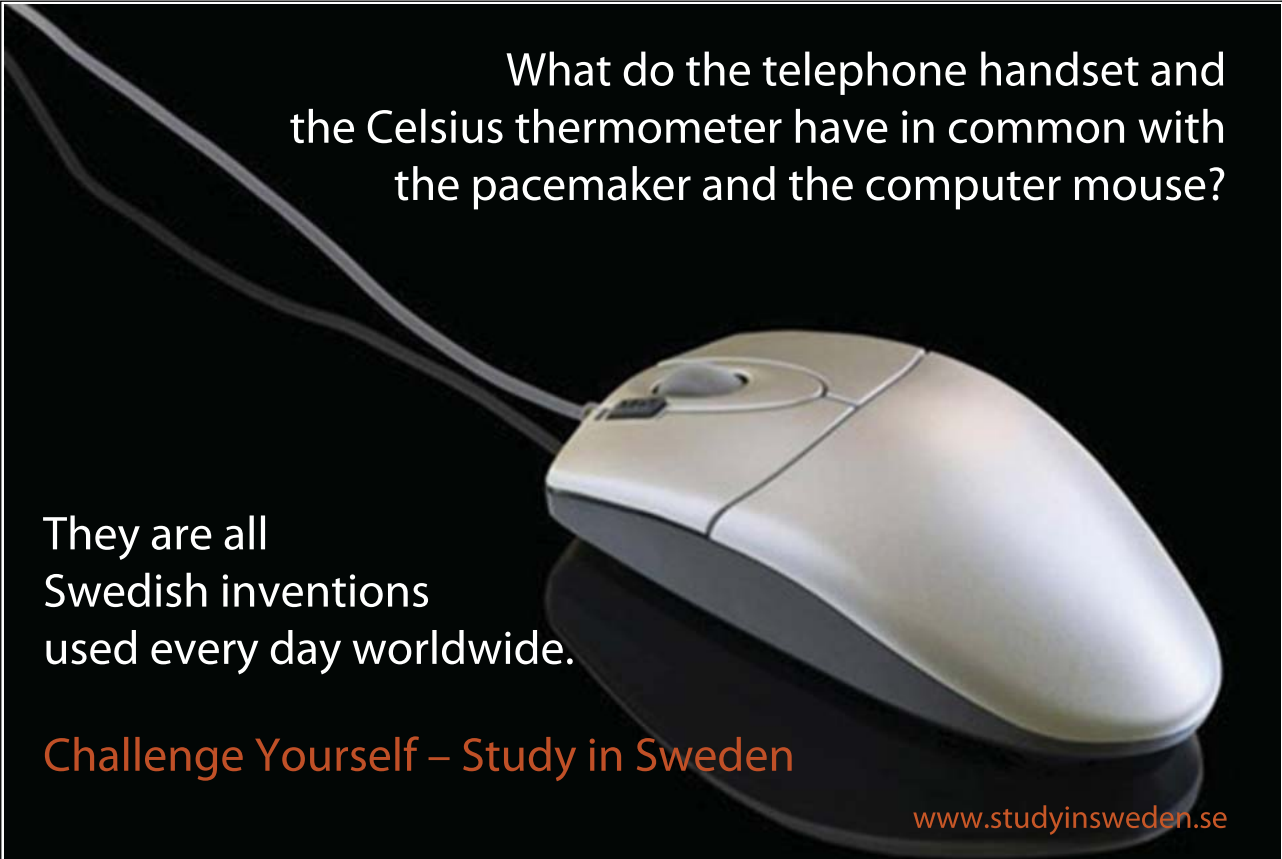

What do the telephone handset and
the Celsius thermometer have in common with
the pacemaker and the computer mouse?

They are all
Swedish inventions
used every day worldwide.

Challenge Yourself – Study in Sweden

www.studyinsweden.se

The rheological equation is as follows

$$\sigma + \frac{\eta}{\mu_M} \dot{\sigma} = 2\mu_H \varepsilon + 2 \frac{\mu_H + \mu_M}{\mu_M} \eta \dot{\varepsilon}. \tag{10.8}$$

The relaxation time τ_{rel} and retardation time τ_{ret} are obtaining from equation (10.8).

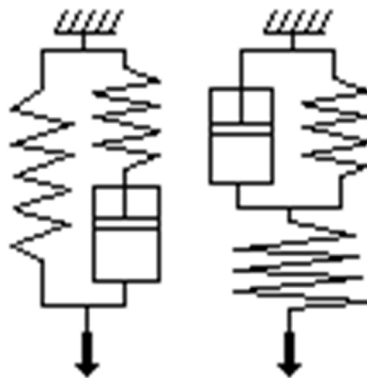

Fig.10.3. Poynting-Thomson mode **Fig.10.4.** Kelvin model

If to assume $\varepsilon(t) = \varepsilon_o = const$, then the solution of equation (10.8) will have the form

$$\sigma(t) = 2\mu_H \varepsilon_o + \sigma_{oM} e^{-\frac{\mu_M t}{\eta}}.$$

The model describes the stress relaxation and the relaxation time is equal to $\tau_{rel} = (\eta/\mu_M)$.

If to assume $\sigma(t) = \sigma_o = const$, then the solution of equation (10.8) will be as follows

$$\varepsilon(t) = \frac{\sigma_o}{2\mu_H} \left(1 - e^{-\frac{\mu_H \mu_M}{\eta(\mu_H + \mu_M)} t} \right).$$

Let at moment $t = t_1$ the loading is stopped. Then the strain will change from the value

$$\varepsilon_1 = \varepsilon(t_1) = \frac{\sigma_o}{2\mu_H} \left(1 - e^{-\frac{\mu_H \mu_M}{\eta(\mu_H + \mu_M)} t_1} \right) \text{ according to the law } \varepsilon(t) = \varepsilon_1 e^{-\frac{\mu_H \mu_M}{\eta(\mu_H + \mu_M)} t}.$$

Thus, the material will return to its initial deformation state with some retardation and the retardation time will distinguish

from the relaxation time and will equal to $\tau_{ret} = \frac{\eta(\mu_H + \mu_M)}{\mu_H \mu_M}$.

Let us pass to the **Kelvin model**.

The procedure of constructing the rheological equation basing on the rheological scheme is like the prior model. Therefore the rheological equation for the Kelvin model can be written right away

$$\frac{\eta_V}{\mu_V + \mu_H} \dot{\sigma} + \sigma = \frac{2\mu_H \eta_V}{\mu_V + \mu_H} \dot{\varepsilon} + \frac{2\mu_H \mu_V}{\mu_V + \mu_H} \varepsilon. \quad (10.9)$$

The Kelvin model is used quite often and sometimes it is called **the standard viscoelastic linear model**. The equation is written in the form

$$n\dot{\sigma} + \sigma = En\dot{\varepsilon} + H\varepsilon, \quad (10.10)$$

where the quantity E is called **the instantaneous modulus of elasticity**, the quantity H is called **the long-termed modulus of elasticity**, the quantity n is called **the relaxation time**.

Note 10.6. Let the deformation process is very quick. Then the rates of stress and strain are essentially more than the stress and strain and the last ones can be neglected. It follows then from equation (10.10) that $\dot{\sigma} = E\dot{\varepsilon}$, that is, the deformation occurs according to the Hooke law with the instantaneous modulus of elasticity E .

If the deformation process is very slow, then the rates of stress and strain can be neglected. It follows then from equation (10.10) that $\sigma = H\varepsilon$, that is, the deformation occurs according to the Hooke law with the long-termed modulus of elasticity H .

Note 10.7. If to compare equations (10.9) and (10.10), then the expressions for moduli $E = 2\mu_H$, $H = \frac{2\mu_H \mu_V}{\mu_V + \mu_H}$ can be obtained, which show that the long-termed modulus is less than the instantaneous one $E > H$.

The differential equation (10.10) can be integrated and then with the condition of the pure elastic behaviour at the initial moment $\sigma(0) = E\varepsilon(0)$ the equations follow

$$\sigma(t) = E\varepsilon(t) - \frac{E-H}{n} \int_0^t \varepsilon(\tau) e^{-\frac{t-\tau}{n}} d\tau, \quad (10.11)$$

$$\varepsilon(t) = \frac{\sigma(t)}{E} - \frac{E-H}{E^2 n} \int_0^t \sigma(\tau) e^{-\frac{H}{En}(t-\tau)} d\tau, \quad (10.12)$$

In fact, formulas (10.11), (10.12) are the integral representation of differential rheological equation (10.10).

Note 10.8. The similar integral relationships were constructed for Maxwell model and Voigt model. In this fact, the general rule relative to differential rheological models is displayed. It will be commented later.

Consider further **three standard cases**.

Case 1. $\varepsilon = \varepsilon_o = \text{const}$. The law of stress change can be obtained from equation (10.11). It characterizes the stress relaxation

$$\sigma(t) = \varepsilon_o \left(H + (E - H) e^{-\frac{t}{n}} \right), \quad (10.13)$$

The relaxation occurs from the initial value $E\varepsilon_o$ to the value $H\varepsilon_o$.

Case 2. $\sigma = \sigma_o = \text{const}$. The law of strain change can be obtained from equation (10.12), which characterizes the strain creep

$$\varepsilon(t) = \sigma_o \left[\frac{1}{H} + \left(\frac{1}{E} - \frac{1}{H} \right) e^{-\frac{H}{En}t} \right], \quad (10.14)$$

The strain at the initial moment takes the value σ_o/E and further increases asymptotically tending to the value σ_o/H .

Please click the advert



Sharp Minds - Bright Ideas!

Employees at FOSS Analytical A/S are living proof of the company value - First - using new inventions to make dedicated solutions for our customers. With sharp minds and cross functional teamwork, we constantly strive to develop new unique products - Would you like to join our team?

FOSS works diligently with innovation and development as basis for its growth. It is reflected in the fact that more than 200 of the 1200 employees in FOSS work with Research & Development in Scandinavia and USA. Engineers at FOSS work in production, development and marketing, within a wide range of different fields, i.e. Chemistry, Electronics, Mechanics, Software, Optics, Microbiology, Chemometrics.

We offer
A challenging job in an international and innovative company that is leading in its field. You will get the opportunity to work with the most advanced technology together with highly skilled colleagues.

Read more about FOSS at www.foss.dk - or go directly to our student site www.foss.dk/sharpminds where you can learn more about your possibilities of working together with us on projects, your thesis etc.

Dedicated Analytical Solutions

FOSS
 Slangerupgade 69
 3400 Hillerød
 Tel. +45 70103370
www.foss.dk

The Family owned FOSS group is the world leader as supplier of dedicated, high-tech analytical solutions which measure and control the quality and production of agricultural, food, pharmaceutical and chemical products. Main activities are initiated from Denmark, Sweden and USA with headquarters domiciled in Hillerød, DK. The products are marketed globally by 23 sales companies and an extensive net of distributors. In line with the corevalue to be 'First', the company intends to expand its market position.





Case 3. $\sigma(t) = \sigma_o \sin \omega t$. In this case, the strain are changing by the harmonic law also

$$\varepsilon(t) = \varepsilon_o \sin(\omega t + \varphi), \quad (10.15)$$

$$\varepsilon_o = \sigma_o \sqrt{\frac{1 + n^2 \omega^2}{H^2 + E^2 n^2 \omega^2}}, \quad \tan \varphi = -\frac{n\omega(E - H)}{H + En^2 \omega^2}.$$

Note 10.9. In contrast to two prior cases, the Kelvin model describes the real materials in more adequate manner. Particularly, the strain amplitude is changing according to (10.15) from one finite value σ_o/H to another finite value σ_o/E . The angle of phase shift is changing from zero to zero through the maximum $\arctan\left(-\frac{E - H}{2\sqrt{EH}}\right)$ under value $n\omega = \sqrt{(H/E)}$.

Thus, four simplest rheological models with corresponding rheological schemes are considered.

A complication of schemes by the parallel and successive linking the elastic and viscous elements effect the complication of the rheological equations that they become the ordinary differential equations of the higher orders and save the constant coefficients.

Comments

It is in place to repeat the Helvetius sentence from Chapter 8

knowledge some of the principles fills a gap in our knowledge of some facts

Relative to the theory of viscoelasticity, this sentence can be changed in the way that knowledge of the Boltzmann and Volterra principles will fill a gap in our knowledge of many specific facts of the theory.

Starting comment is associated with properties of basic elements in rheological schemes.

Elastic body. Constitutive equation is written for the shear deformation state only and is assumed in the form of Hooke law $\sigma = 2\mu\varepsilon$, where μ is elastic shear modulus (Lame modulus) and is measured in pascals (Pa). For conventional materials, the Lamé modulus μ possesses the values with orders from 10^{10} (polypropylene) to 10^{12} (tungsten).

Viscous fluid. Constitutive equation is written for the shear stress state only and is assumed in the form of Navier-Stokes law $\sigma = 2\eta\dot{\varepsilon}$, where η is the dynamical coefficient of shear viscosity and is measured in poises (Ps, 1 Ps = 1 Pa × 1s). For conventional fluids, the coefficient of shear viscosity possesses the values from 0 (ideal fluid) to 10^3 (castor oil).

The knowledge of basic physical measures is important in mechanics. It is said a student explains usually what is the horse power: in the Paris Board of Weights and Measures, the horse is kept in height 1 meter and in weight 1 kilogram, and just it has the power output in 1 horse-power.

The first comment to simplest rheological models is that they are very useful for explanation of the theory of viscoelasticity and the basic viscoelastic effects, but the more advanced models should be used for description of real materials.

The second comment is associated with the set of three cases, considered for each differential model. This set has the common character for all the models.

The case 1 tests ability of the model to describe the stress relaxation. The case 2 tests ability of the model to describe the creep. The case 3 tests ability of the model to describe the link between stress and strain oscillations as well as the phase shift under harmonic loading.

The third comment is related to the formulation of basic system of equations of the theory of viscoelasticity. This system is formed from the analogous system of the theory of elasticity by the change of constitutive equations.

Further reading

1. Bland, DR 1960, *The Theory of Linear Viscoelasticity*. Oxford University Press, Oxford.
2. Boltzmann, L 1874, 'Zur Theorie der elastischen Nachwirkung', *Sitzungsberichte der Mathematisch-Naturwissenschaftlichen Klasse der Kaiserlichen Akademie der Wissenschaften*, Bd.70, N2.
3. Boltzmann, L 1876, 'Zur Theorie der elastischen Nachwirkung', *Annalen der Physik and Chemie*, Erg. Bd. 7.
4. Christensen, RM 1971, *Theory of Viscoelasticity. An Introduction*, Academic Press, New York.
5. Ferry, JD 1970, *Viscoelastic Properties of Polymers*, 2nd edn. Academic Press, New York.
6. Gross, B 1968, *Mathematical Structure of the Theories of Viscoelasticity*, Herrmann, Paris.
7. Ilyushin, AA & Pobedrya, BE 1970, *Fundamentals of the Mathematical Theory of Thermoviscoelasticity*. Nauka, Moscow. (In Russian)
8. Malmeister, AK, Tamuzhs, VP & Teters, GA 1967, *Strength of Rigid Polymer Materials*. Zinatne, Riga. (In Russian)
9. Moskvitin, VV 1972, *Strength of Viscoelastic Materials as applied to the Charges of Booster Engines on the Solid Fuel*. Nauka, Moscow. (In Russian)
10. Rabotnov, YuN 1988, *Solid Mechanics*. Nauka, Moscow. (In Russian)
11. Reiner, M 1958, *Rheology*, Handbuch der Physik. Ed. S.Flügge. Bd.6. Elastizität und Plasticität. Springer-Verlag, Berlin.
12. Savin, GN & Rushchitsky, JJ 1976, *Elements of Mechanics of Hereditary Media*, Vyscha Shkola, Kiev. (In Ukrainian)
13. Volterra, V 1959, *Theory of Functionals and of Integral and Integro-Differential Equations*. Dover Publ., New York.

Questions

- 10.1. Sketch the possible four-element rheological schemes including the elastic and viscous elements. Show interest in, which of them have been studied in rheology.
- 10.2. In what way the number of independent relaxation times depend on the order of differential rheological equation?
- 10.3. Create the rheological models, in which the Voigt or Maxwell models are linked successively n times. Write corresponding rheological equations and comment them.
- 10.4. Let interest in the problem of commensurability of relaxation on times for real materials (usually each subsequent relaxation time is one-two orders more than the prior one).

11 Viscoelastic volume and shear waves

Basic viscoelastic models. Rheological equations. Relaxation and creep kernels. Duffing and Boltzmann kernels. Fractional-exponential operators. General statement of the theory of viscoelasticity. Volume and shear waves.

The prior chapter was finished by the statement that a complication of schemes by the parallel and successive linking the elastic and viscous elements effect the complication of the rheological equations that they become the ordinary differential equations of the higher orders and save the constant coefficients.

In the general case, the equation can be represented in the form

$$a_0 \frac{d^n \sigma}{dt^n} + a_1 \frac{d^{n-1} \sigma}{dt^{n-1}} + \dots + a_n \sigma = b_0 \frac{d^n \varepsilon}{dt^n} + b_1 \frac{d^{n-1} \varepsilon}{dt^{n-1}} + \dots + b_n \varepsilon \quad \text{or} \quad P^n \sigma = Q^n \varepsilon. \quad (11.1)$$

The equation (11.1) is usually divided on two types: Voigt type, when $b_n \neq 0$, and Maxwell type, when $b_n = 0$.

Most often, no the differential representation (11.1) is used, but the equivalent to (11.1) integral representation.

Note 11.1. For some reason, the integral form of rheological equations seems to be more convenient for physical (mechanical) comment of viscoelastic problems. It permits to avoid of scholastic and formal analysis of viscoelastic models.

For this purpose, the operators are introduced

$$\hat{I}(t)x = \int_0^t x(\tau) d\tau \rightarrow \frac{1}{\hat{I}} \equiv \frac{d}{dt}, \quad (11.2)$$

$$\hat{E}_o(-\beta, t)x = \hat{E}_o = \int_0^t x(\tau) e^{-\beta(t-\tau)} d\tau, \quad (11.3)$$

$$\frac{1}{1 + \beta \hat{I}(t)} = 1 - \beta \hat{E}_o(-\beta, t). \quad (11.4)$$

It should be then acted on equation (11.1) by the operator $(\hat{\mathbf{I}})^n$ and obtain as a result

$$A(\hat{\mathbf{I}})\sigma = B(\hat{\mathbf{I}})\varepsilon, \quad (11.5)$$

$$A = a_0(\hat{\mathbf{I}})^0 + a_1(\hat{\mathbf{I}})^1 + \dots + a_n(\hat{\mathbf{I}})^n = a_0(1 + \alpha_1\hat{\mathbf{I}})\dots(1 + \alpha_n\hat{\mathbf{I}}),$$

$$B = b_0(\hat{\mathbf{I}})^0 + b_1(\hat{\mathbf{I}})^1 + \dots + b_n(\hat{\mathbf{I}})^n = b_0(1 + \beta_1\hat{\mathbf{I}})\dots(1 + \beta_n\hat{\mathbf{I}}),$$

where the roots $(\alpha_k)^{-1}, (\beta_k)^{-1}$ ($k=1, \dots, n$) will be positive and not equal each other from some physical considerations.

The formal solutions of equation (11.5) relative the stress or strain give the representation in the form of integral equation.

The solving relative the stress is done by the formal representation (11.5) in the form $\sigma = \left[B(\hat{\mathbf{I}})/A(\hat{\mathbf{I}}) \right] \varepsilon$. Further the fraction $B(\hat{\mathbf{I}})/A(\hat{\mathbf{I}})$ should be expanded into the simplest fractions $(B(\hat{\mathbf{I}})/A(\hat{\mathbf{I}})) = A_0 + \sum_{i=1}^n \frac{A_i}{1 + \alpha_i \hat{\mathbf{I}}}$ and finally formula (11.4) must be applied to the obtained expression. As a result, the equation is obtained

$$\sigma(t) = \left\{ A_0 + \sum_{i=1}^n A_i [1 - \alpha_i \hat{\mathbf{E}}_o(-\alpha_i, t)] \right\} \varepsilon(t) = \left(A_0 + \sum_{i=1}^n A_i \right) \varepsilon(t) - \sum_{i=1}^n A_i \alpha_i \hat{\mathbf{E}}_o(-\alpha_i, t) \varepsilon(t).$$

Please click the advert

The Wake

the only emission we want to leave behind

Low-speed Engines Medium-speed Engines Turbochargers Propellers Propulsion Packages PrimeServ

The design of eco-friendly marine power and propulsion solutions is crucial for MAN Diesel & Turbo. Power competencies are offered with the world's largest engine programme – having outputs spanning from 450 to 87,220 kW per engine. Get up front! Find out more at www.mandieselturbo.com

Engineering the Future – since 1758.

MAN Diesel & Turbo



Download free ebooks at bookboon.com

If to take into account representation (11.3) and introduce the integral, then

$$\sigma(t) = A\varepsilon(t) - \int_0^t \Gamma(t-\tau)\varepsilon(\tau)d\tau, \quad (11.6)$$

$$A = A_0 + \sum_{i=1}^n A_i, \quad \Gamma(t-\tau) = \sum_{i=1}^n A_i \alpha_i e^{-\alpha_i(t-\tau)}. \quad (11.7)$$

The equation (11.6) is the Volterra integral equation of the second kind with the kernel of the convolution type, but this kernel is the sum of exponents and represents therefore the particular case.

Definition 11.1. The function Γ is called **the relaxation kernel**, the introduced before roots $(\alpha_k)^{-1}$ ($k = 1, \dots, n$) are called **the relaxation times** and their totality forms **the relaxation spectrum**.

Note 11.2. This spectrum is discrete and finite (although it could be the discrete infinite or the continuous one), but this feature is caused by the particular representation of rheological equation (it is written as the differential equation with constant coefficients).

If the case $\varepsilon = \varepsilon_0 = \text{const}$ is considered, then from equation (11.6) the expression can be obtained, which describes the simple stress relaxation

$$\sigma(t) = \left(A - \int_0^t \Gamma(t-\tau)d\tau \right) \varepsilon_0 = \left[A - \sum_{i=1}^n A_i (1 - e^{-\alpha_i t}) \right] \varepsilon_0.$$

This expression is commented usually for two cases: $t = 0$ and $t \rightarrow \infty$.

The first case gives $\sigma(0) = A\varepsilon_0$, from which follows that the constant $A = A_0 + \sum_{i=1}^n A_i = \sum_{i=0}^n A_i$ is the **instantaneous modulus of elasticity**. The second case gives $\sigma(\infty) = A_0\varepsilon_0$. Thus, A_0 is the **long-termed modulus of elasticity**.

The solution of equation (11.5) relative to the strain gives by similar procedure of expanding on the simplest fractions the integral equation

$$\varepsilon(t) = B\sigma(t) - \int_0^t K(t-\tau)\sigma(\tau)d\tau, \quad (11.8)$$

$$B = B_0 + \sum_{i=1}^n B_i, \quad K(t-\tau) = \sum_{i=1}^n B_i \beta_i e^{-\beta_i(t-\tau)}.$$

Definition 11.2. The function K is called **the retardation kernel**, the introduced before roots $(\beta_k)^{-1}$ ($k = 1, \dots, n$) are called **the retardation times** and their totality forms **the retardation spectrum**.

If the case $\sigma = \sigma_0 = \text{const}$ is considered, then from equation (11.5) the expression can be obtained, which describes **the simple creep**

$$\varepsilon(t) = \left(B - \int_0^t K(t-\tau) d\tau \right) \sigma_0 = \left[B - \sum_{i=1}^n B_i (1 - e^{-\beta_i t}) \right] \sigma_0.$$

On this fact, analysis of the simple rheological models is finished.

The shown in the chapter simple differential models of one-dimensional viscoelastic deformation of materials are generalized **in two directions**.

In the first direction rheological equation in the form of the Volterra integral equation with kernels of particular form is generalized on the arbitrary kernels satisfying the condition of fading memory.

In the second direction the representation of rheological equation is generalized on the three-dimensional case in such a way that the elastic moduli are changed on the viscoelastic operators.

Let us try to construct the bridge between differentially described models and the general theory of viscoelasticity built according to Boltzmann and Volterra and using Volterra integral operators of difference type. The basic new notions will be **exponential kernels** and **fractional-exponential kernels**, which satisfy the general principle of fading memory.

Let us start with integral representations of rheological equations. The described above procedure for integral representation (11.6), (11.8) can be considered as a particular case for integral representations with degenerate kernels.

Definition 11.3. A kernel $K(x, t)$ is degenerate, if it is the finite sum of products of two functions, one of which depends on t only, whereas another one depends on x only $K(x, t) = \sum_{i=1}^n X_i(x) T_i(t)$.

An integral equation with degenerate kernel can be written

$$u(x) + \sum_{i=1}^n X_i(x) \int_0^x T_i(t) u(t) dt = f(x). \quad (11.9)$$

Then the next procedure should be realized: to differentiate equation (11.9) n times relative to x and so on. As a result, the equivalent to integral equation (11.9) differential equation with variable coefficients will be obtained

$$\frac{d^N u}{dx^N} + a_1(x) \frac{d^{N-1} u}{dx^{N-1}} + \dots + a_{N-1}(x) \frac{du}{dx} + a_N(x) u = \tilde{f}(x). \quad (11.10)$$

So, integral representation (11.9) with degenerate kernel can be transformed into differential representation (11.10) with variable coefficients $a_k(x)$.

Note 11.3. The representation (11.10) is the most general differential one for the linear case. Nevertheless, the integral equivalent representation will have the very particular form.

These links between integral and differential equations are useful for theory of viscoelasticity and the shown above analysis can be continued.

Note 11.4. Why it is useful and important? First of all, because of the integral representation of constitutive equations in viscoelasticity has the best physical interpretations (the basic principle of fading memory is adapted for integral kernels and basic experimental observations – creep and relaxations curves – are well commented within the framework of integral representations). In some cases of using the differential representation, the best mechanical understanding can be achieved by transition to the integral representation.

The next step in constructing the general theory of viscoelasticity is associated with introducing into the theory **the fractional-exponential kernels**.

This type of viscoelastic kernels was proposed because exponential kernels and corresponding differential constitutive equations have some unavoidable defect linked with necessity of right description of observed experimentally creep curves.

If at moment $t = t_0$ the constant load is applied instantaneously, then the creep curves have usually the form shown on Fig. 11.1 (the distinguishing curves will be obtained for different values of the load; all the curves are limited from above for small values, that is, the steady-state creep will be described; whereas for the long-term loading the creep will be not limited).

Please click the advert



Technical training on *WHAT* you need, *WHEN* you need it

At IDC Technologies we can tailor our technical and engineering training workshops to suit your needs. We have extensive experience in training technical and engineering staff and have trained people in organisations such as General Motors, Shell, Siemens, BHP and Honeywell to name a few.

Our onsite training is cost effective, convenient and completely customisable to the technical and engineering areas you want covered. Our workshops are all comprehensive hands-on learning experiences with ample time given to practical sessions and demonstrations. We communicate well to ensure that workshop content and timing match the knowledge, skills, and abilities of the participants.

We run onsite training all year round and hold the workshops on your premises or a venue of your choice for your convenience.

For a no obligation proposal, contact us today at training@idc-online.com or visit our website for more information: www.idc-online.com/onsite/

Phone: **+61 8 9321 1702**
 Email: training@idc-online.com
 Website: www.idc-online.com



OIL & GAS
ENGINEERING

ELECTRONICS

AUTOMATION &
PROCESS CONTROL

MECHANICAL
ENGINEERING

INDUSTRIAL
DATA COMMS

ELECTRICAL
POWER

The peculiarity of these curves is the steep ascent for an initial stage of loading. This corresponds to very high rate of deformation at initial moments after application of the load.

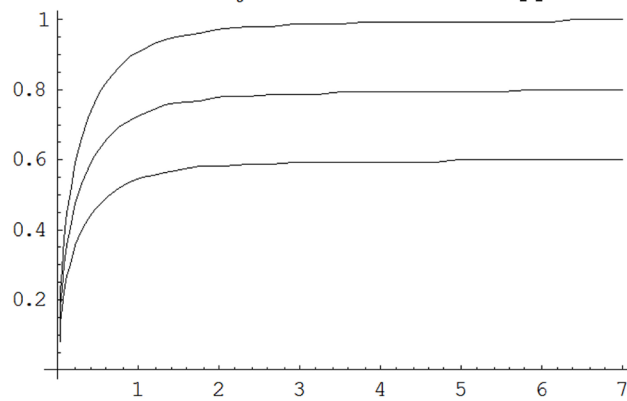

Fig.11.1. Creep curves

If the process is described by Volterra integral equation

$$\varepsilon(t) = \frac{1}{E} \left[\sigma(t) + \int_0^t K(t-\tau) \sigma(\tau) d\tau \right], \quad (11.11)$$

then the kernel $K(t-t_0)$ must tend to infinity for $t \rightarrow t_0$.

Note 11.5. Of course, the rate of deformation isn't infinity. The common point of view is that this incorrectness can be put right by taking into account inertial forces.

Note 11.6. Representation (11.11) with $\frac{1}{E}$ before the braces is convenient for few reasons. Firstly, in this case, the quantity E can be meant as the instantaneous modulus of elasticity. Secondly, the creep kernel has convenient dimension $[1/s]$. Thirdly, the long-termed modulus of elasticity has a simple form $H = \left[E / \left(1 + \int_0^\infty K(\xi) d\xi \right) \right]$.

Fourthly, the notion of **the defect of modulus** $\Delta E = \frac{E-H}{H}$ can be introduced and linked with the creep kernel

$$\Delta E = \int_0^\infty K(\xi) d\xi.$$

It follows from (11.11) $\dot{\varepsilon}(t_0) = \frac{1}{E} \lim_{t \rightarrow t_0} K(t-t_0) = \infty$. This means that function $K(\xi)$ has a singularity at $\xi = 0$. Let us now note that defect of modulus must be finite according to the definition, what means in turn that the improper integral $\Delta E = \int_0^\infty K(\xi) d\xi$ must converge and therefore the singularity must be weak, that is it must be of the form (C/ξ^α) $\alpha \in (0;1)$.

The simplest kernel with such singularity was proposed by Duffing (1931)

$$K(\xi) = (C/\xi^\alpha), \quad \alpha \in (0;1). \quad (11.12)$$

Of course, the Boltzmann kernel $K(\xi) = (C/\xi)$ (1874) is the partial case of (11.12), but it is no longer weak singular.

Change slightly the Duffing kernel

$$K(t-\tau) = I_\alpha(t-\tau) = \frac{(t-\tau)^\alpha}{\Gamma(1-\alpha)}, \quad \alpha \in (-1;0) \quad (\Gamma \text{ is here the Euler function}) \quad (11.13)$$

and remember that in the theory of integral equations similar kernels are called **the Abel kernels**.

Therefore later the operator

$$\widehat{I}_\alpha x(t) = \int_0^t I_\alpha(t-\tau)x(\tau)d\tau = \int_0^t \frac{(t-\tau)^\alpha}{\Gamma(1-\alpha)} x(\tau)d\tau, \quad \alpha \in (-1;0) \quad (11.14)$$

was called **the Abel operator**.

Note 11.7. The operator (11.14) is the basic one in the theory of fractional differentiation. It can be written as the fractional time operator $\frac{d^\alpha x(t)}{dt^\alpha} = \frac{1}{\Gamma(1-\alpha)} \int_{-\infty}^t \frac{dx(\tau)}{(t-\tau)^\alpha}$ ($\alpha \in (0;1)$).

Consider now the simple integral equation with Abel kernel $(1 + \beta \widehat{I}_\alpha)x = y$ and solve the equation

$$x = \frac{1}{1 + \beta \widehat{I}_\alpha} y, \quad (11.15)$$

then consider expression $\frac{1}{1 + \beta \widehat{I}_\alpha}$ as the sum of geometric progression with the ratio $(-\beta \widehat{I}_\alpha)$ and assume the expansion $\frac{1}{1 + \beta \widehat{I}_\alpha} = 1 - \beta \widehat{I}_\alpha + (-\beta \widehat{I}_\alpha)^2 + (-\beta \widehat{I}_\alpha)^3 + \dots$ is valid, then formula (11.15) can be written as

$$x = \left[1 - \beta \widehat{I}_\alpha + \beta^2 (\widehat{I}_\alpha)^2 - \beta^3 (\widehat{I}_\alpha)^3 + \dots \right] y. \quad (11.16)$$

Note 11.8. There are a simple rule for products of Abel operators $\widehat{I}_{\alpha_1} \cdot \widehat{I}_{\alpha_2} = \widehat{I}_{\alpha_1 + \alpha_2 + 1}$, from which the exponentiation of Abel operators follows $(\widehat{I}_\alpha)^n = \widehat{I}_{n-1 + \alpha n}$.

Using the note above, the series (11.16) can be folded

$$x = \left(1 + \sum_{n=1}^{\infty} \beta^n (\widehat{I}_\alpha)^n \right) y = \left(1 + \sum_{n=1}^{\infty} \beta^n \widehat{I}_{n\alpha + n - 1} \right) y = y + \int_0^t \sum_{n=1}^{\infty} \beta^n I_{n\alpha + n - 1}(t-\tau)y(\tau)d\tau =$$

$$= y + \beta \int_0^t (t-\tau)^\alpha \sum_{m=0}^{\infty} \frac{\beta^m (t-\tau)^{m(1+\alpha)}}{\Gamma[(n+1)(1+\alpha)]} y(\tau) d\tau = [1 + \beta \widehat{E}_\alpha(\beta, t-\tau)] y.$$

Definition 11.4. The kernel of obtained integral equation

$$E_\alpha(\beta, t-\tau) = (t-\tau)^\alpha \sum_{m=0}^{\infty} \frac{\beta^m (t-\tau)^{m(1+\alpha)}}{\Gamma[(n+1)(1+\alpha)]} \tag{11.17}$$

is called **the fractional-exponential kernel** and corresponding operator

$$\widehat{E}_\alpha y = \int_0^t E_\alpha(\beta, t-\tau) y(\tau) d\tau = \int_0^t (t-\tau)^\alpha \sum_{m=0}^{\infty} \frac{\beta^m (t-\tau)^{m(1+\alpha)}}{\Gamma[(n+1)(1+\alpha)]} y(\tau) d\tau \tag{11.18}$$

is called **the fractional-exponential operator**.

Note 11.9. For $\alpha=0$ the fractional-exponential function is transformed into the exponential function. If to remember that the starting operator \widehat{I}_α is linked with fractional differentiation, then it becomes clear why JuN Rabotnov introduced the term “**fractional-exponential**”.

Note 11.10. In all the applications β turns out negative. Therefore, the form $E_\alpha(-\beta, t)$ is often used.

Please click the advert

I joined MITAS because
I wanted **real responsibility**

The Graduate Programme
for Engineers and Geoscientists
Maersk.com/Mitas





Month 16

I was a construction supervisor in the North Sea advising and helping foremen solve problems

Real work
International opportunities
Three work placements





Two useful relationships can be written

$$\frac{1}{1 - \beta \widehat{I}_\alpha(t)} = 1 + \beta \widehat{E}_\alpha(\beta, t), \quad \frac{1}{1 - \omega \widehat{E}_\alpha(\beta, t)} = 1 + \omega \widehat{E}_\alpha(\beta + \omega, t). \quad (11.19)$$

Using the fractional-exponential functions in viscoelasticity is associated with **the Volterra principle** and so called evaluation or **decoding the operator expressions**.

It should be formulated that using the Abel and fractional-exponential operators as well as the similar to them operators with kernels associated with experiments for particular kinds of materials presents the practical part of the theory of viscoelasticity. The abstract part is based on using the arbitrary Volterra integral operators.

Let us now formulate **the general formulation of the theory**.

As it was mentioned above, the linear theory of viscoelasticity is constructed basing on the classical linear theory of elasticity. The basic system of the theory of elasticity includes four groups of equations and the boundary conditions:

1. **The Cauchy equations** $\varepsilon_{ik} = \frac{1}{2}(u_{i,k} + u_{k,i})$. (11.20)

2. **The Saint-Venant relationships** $\varepsilon_{ik,jl} + \varepsilon_{jl,ik} - \varepsilon_{il,jk} - \varepsilon_{jk,il} = 0$. (11.21)

3. **The equation of motion** $\sigma_{ik,k} + \rho F_i = \rho \ddot{u}_i$. (11.22)

4. **The constitutive equations for anisotropic materials** $\sigma_{ik} = C_{iklm} \varepsilon_{lm}$, (11.23)

4. **(for isotropic materials** $\sigma_{ik} = \lambda \varepsilon_{mm} \delta_{ik} + 2\mu \varepsilon_{ik}$). (11.24)

5. **Boundary conditions (for two simplest cases) for all boundary surface points**

$$\sigma_{ik} n_k = S_i^o, \quad u_k = u_k^o. \quad (11.25)$$

Consider now the transition from system (11.20)-(11.25) to the system, corresponding to the general theory of viscoelasticity.

The most important in this transition is that constitutive equations (11.23) or (11.24) will be changed and all the rest equations will be unchanged.

Choose the isotropic case (11.24) and show the procedure more in detail. So, the Lamé elastic constants λ, μ must be changed on viscoelastic operators in the form of Volterra integral operators

$$\widehat{V} \cdot u(x, t) \equiv \int_0^t V(t - \tau) u(x, \tau) d\tau.$$

Then in formulas (11.24) the constants λ, μ must be substituted by operators

$$\bar{\lambda} = \lambda(1 - \widehat{\Lambda}), \quad \bar{\mu} = \mu(1 - \widehat{M}). \quad (11.26)$$

and new constitutive equations will have the form

$$\sigma_{ik} = \bar{\lambda} \varepsilon_{mm} \delta_{ik} + 2\bar{\mu} \varepsilon_{ik}. \quad (11.27)$$

It is well-known that system (11.20)-(11.24) in the isotropic case can be reduced to the classical Lamé system

$$(\lambda + \mu) \text{grad div } \bar{u} + \mu \Delta \bar{u} = \rho \partial^2 \bar{u} / \partial t^2. \quad (11.28)$$

Corresponding system for viscoelastic materials will be as follows

$$(\bar{\lambda} + \bar{\mu}) \text{grad div } \bar{u} + \bar{\mu} \Delta \bar{u} = \rho \partial^2 \bar{u} / \partial t^2. \quad (11.29)$$

In the next analysis of viscoelastic waves in isotropic materials this system will be the basic one.

Note 11.11. In the static problems of viscoelasticity, when the right hand terms (inertial terms) in equations (11.29) are absent, the **Volterra principle** is very effective. It consists in that any static problem of viscoelasticity can be solved as if it is the elastic problem and in the final expressions the elastic constants should be substituted by the viscoelastic operators.

Let us narrow the problem of waves by two assumptions. **The first assumption**, properly speaking, does not narrow the problem for harmonic waves. It is formulated as follows: **all the basic functions are changed by the harmonic law**.

For equation (11.29), the assumption means that the displacement vector should be written in the form $u_k(x, t) = \Re \{ u_k^o(x) e^{i\omega t} \}$, where $u_k^o(x)$ is now the complex-value quantity, the frequency ω is given, $x \equiv (x_1, x_2, x_3)$.

The second assumption is associated with the representation of the constitutive equations and hence the viscoelastic operators. So, let the constitutive equations are written in the general differential form for symmetric and anti-symmetric parts of stress and strain tensors

$$\sum_{i=1}^n a_i^{(\kappa)} \frac{d^i \sigma_{mm}}{dt^i} = \sum_{i=1}^n b_i^{(\kappa)} \frac{d^i \varepsilon_{mm}}{dt^i}, \quad \sum_{i=1}^n a_i^{(\mu)} \frac{d^i s_{mk}}{dt^i} = \sum_{i=1}^n b_i^{(\mu)} \frac{d^i e_{mk}}{dt^i}. \quad (11.30)$$

On next step, the Laplace transform relative to time should be applied and then the Lamé equations (11.29) will be as follows

$$(Y_\kappa + (1/3)Y_\mu) \text{grad div } \bar{u}^o + Y_\mu \Delta \bar{u}^o = \rho \omega^2 \bar{u}^o. \quad (11.31)$$

$$\text{where } Y_\kappa = Y_\kappa(i\omega) = \left(\frac{\sum_{i=1}^n a_i^{(\kappa)} (i\omega)^i}{\sum_{i=1}^n b_i^{(\kappa)} (i\omega)^i} \right), \quad (11.32)$$

$$Y_\mu = Y_\mu(i\omega) = \left(\frac{\sum_{i=1}^n a_i^{(\mu)} (i\omega)^i}{\sum_{i=1}^n b_i^{(\mu)} (i\omega)^i} \right). \quad (11.33)$$

Definition 11.5. The quantities (11.32) and (11.33) corresponds to bulk elastic modulus κ and shear elastic modulus μ , respectively, and are called **the complex moduli**. They are the complex quantities and characterize the dependence of stress amplitudes on strain amplitudes, when the frequency is changed.

Definition 11.6. The quantities $I_\kappa(i\omega), I_\mu(i\omega)$ inverse to complex moduli (11.32) and (11.33) are called **the complex compliances**. In some cases the use of complex compliances is more convenient.

The representation (11.31) like its elastic analog (11.28) contains (can be splitted) two wave equations relative the volume and shear waves.

Let us apply to equation (11.31) the operation div . Then this equation will transform into the classical Helmholtz equation

$$\left[\Delta + \left(\rho \omega^2 / (Y_\kappa + (4/3) Y_\mu) \right) \right] \text{div} \vec{u}^o = 0. \quad (11.34)$$

If to assume that $\text{div} \vec{u}^o(x)$ propagates as the plane wave in the direction, given by the unit vector $\vec{l} \equiv (l_1, l_2, l_3)$, then the solution of equation (11.34) is as follows

$$\text{div} \vec{u}^o = A e^{\pm i \omega \sqrt{3 \rho / 3 Y_\kappa + 4 Y_\mu} (\vec{l} \cdot \vec{r})}, \quad (11.35)$$

where A is arbitrary constant amplitude, $\vec{r} \equiv (x_1, x_2, x_3)$ is the radius-vector.

Please click the advert



www.job.oticon.dk

oticon
PEOPLE FIRST

The expression (11.35) determines the deformations, which describes the volume change only in the viscoelastic material. When being passed to originals (for the Laplace transform), then the volume wave is obtained with the complex-valued and depending on frequency wave number

$$\operatorname{div} \vec{u} = \Re \left\{ A e^{i\omega \left[t \pm \sqrt{3\rho/3Y_\kappa + 4Y_\mu} (\vec{i} \cdot \vec{r}) \right]} \right\}, \quad (11.36)$$

This wave propagates with the velocity $v_{ph} = \sqrt{\Re(3Y_\kappa + 4Y_\mu)/3\rho}$. The propagation will be accompanied with the amplitude attenuation by the exponential law with depending on frequency coefficient $k_{at} = -\omega \sqrt{3\rho/\Im(3Y_\kappa + 4Y_\mu)}$.

Apply now to equation (11.31) the operation rot . Then the equation will transform and become the form of Helmholtz equation

$$\left[\Delta + (\rho\omega^2/Y_\mu) \right] \operatorname{rot} \vec{u}^o = 0. \quad (11.37)$$

Analogously to prior case, the solution will give the wave linked with the form changing. That is, the shear wave will be obtained

$$\operatorname{rot} \vec{u} = \Re \left\{ B e^{i\omega \left[t \pm \sqrt{\rho/Y_\mu} (\vec{i} \cdot \vec{r}) \right]} \right\}. \quad (11.38)$$

The phase velocity of viscoelastic shear waves will depend on frequency $v_{ph} = \sqrt{\Re Y_\mu/\rho}$ and the wave propagation will be accompanied with the amplitude attenuation by the exponential law with depending on frequency coefficient $k_{at} = -\omega \sqrt{\rho/\Im Y_\mu}$.

Thus, both types of waves – volume and shear – have the identical properties. In contrast to the elastic waves, the viscoelastic waves have the wave numbers depending on frequency. But it is the basic attribute of dispersivity of waves.

**So, the new property of viscoelastic waves consists in that they are dispersive ones.
The second new property agrees fully with presence of viscosity in the materials –
the viscoelastic wave decay.**

Both properties are characteristic for all the types of viscoelastic waves.

Comments

The theory of viscoelasticity abounds in experimental observations of creep and relaxation. But it should remember that results of experiments depend often very essentially on experiment conditions. Just the thorough description of conditions is not always presented in publications. Besides, the observed in experiment phenomenon is frequently interpreted subjectively enough. Sometimes the reader needs the portion of scepticism.

As, for example, in the well-known story on the travel by train over Scotland of three friends: philosopher, physicist, and mathematician. The philosopher is seeing a black ewe through the train window and saying: Here I am to seeing at first hand that all the ewes in Scotland are black. The physicist returned: You are seeing that in Scotland the black ewes occur. The mathematician defined more exactly: You both are seeing only one ewe, which is black from one side.

Using the Boltzmann kernel implies the logarithmical law of changing the creep deformation. In this consists an advantage of the Boltzmann kernel, because this law was many times observed in experiments for different materials. But owing to strong singularity, an improper integral of this kernel diverges. To avoid this divergence, it was proposed to change the kernel to

$$K(t - \tau) = (C / (t - \tau + \tau_0)) \quad (\tau_0 \neq 0).$$

Then for the creep under constant stress will be $\varepsilon(t) = \sigma_0 \left(\frac{1}{E} + C \ln \frac{t + \tau_0}{\tau_0} \right)$.

This improvement isn't sufficient for avoiding all defects of the Boltzmann kernel. As it was mentioned before, immediately after applying the load the rate of creep is so much that its measurement is with difficulty. The Boltzmann kernel describes the infinite rate of deformation at moment of loading, but owing to strong singularity the deformation is found also infinite. Just this defect can be removed by the Duffing kernel. The creep under constant load will be described in the best form

$$\varepsilon(t) = \sigma_0 \left(\frac{1}{E} + \frac{C}{1 - \alpha} t^{1 - \alpha} \right).$$

This power law corresponds well to initial stages of loading. Duffing proposed $\alpha = 0,7$, other authors - 0,8.

Finally, the standard for Volterra integral equations link between the relaxation kernel $\Gamma(t, \tau)$ and the creep kernel $K(t, \tau)$ should be noted $\Gamma(t, \tau) = K(t, \tau) + \int_{\tau}^t \Gamma(t, \xi) K(\xi, \tau) d\xi$. The first one is the resolvent for the second one and vice versa.

Further reading

1. Bland, DR 1960, *The Theory of Linear Viscoelasticity*, Oxford University Press, Oxford.
2. Christensen, RM 1971, *Theory of Viscoelasticity. An Introduction*, Academic Press, New York.
3. Ferry, JD 1970, *Viscoelastic Properties of Polymers*. 2nd edn, Academic Press, New York.
4. Gross, B 1968, *Mathematical Structure of the Theories of Viscoelasticity*, Hermann, Paris.
5. Rabotnov, YuN 1988, *Solid Mechanics*, Nauka, Moscow. (In Russian)
6. Rushchitsky, JJ & Tsurpal, SI 1998, *Waves in Materials with the Microstructure*, SP Timoshenko Institute of Mechanics, Kiev. (In Ukrainian)
7. Savin, GN & Rushchitsky, JJ 1976, *Elements of Mechanics of Hereditary Media*, Vyshcha Shkola, Kiev. (In Ukrainian)

Questions

- 11.1. Write the resolvent of the Duffing kernel. Whether will be it the difference type?
- 11.2. Consider the Rzhantsyn kernel $K(t-\tau) = \frac{a}{(t-\tau)^\alpha} e^{-\beta(t-\tau)}$. Compare the resolvent of this kernel, found by Wulfson, with the resolvent of the Duffing kernel and comment.
- 11.3. Try to build the resolvents for kernels $K(t) = ae^{-\beta t^k} t^{k_2-1}$, $K(t) = ae^{-\beta t^\alpha} t^{\alpha-1}$, $K(t) = ae^{-\beta t} t^{\alpha-1}$.
- 11.4. Formulate the Volterra condition of the closed loop.
- 11.5. The Volterra correspondence principle is based on commutative property of operations in time and in space coordinates. Why it is not applicable to problems of wave propagation?
- 11.6. Let interest in the approximate expressions for the fractional-exponential kernels. In which will consist the advantage of approximate expressions?

Please click the advert



What do the telephone handset and the Celsius thermometer have in common with the pacemaker and the computer mouse?

They are all Swedish inventions used every day worldwide.

Challenge Yourself – Study in Sweden

www.studyinsweden.se

12 Viscoelastic plane waves

Viscoelastic plane waves. Main features on an example of the plane waves in cases of the classical and structural models.

The simplest example of viscoelastic wave analysis can be found in the distant review (Davies, RM 1956). The problem of wave propagation in the thin rod is there considered in the classical approach, that is, the equation of motion is chosen as follows

$$\rho \frac{\partial^2 u}{\partial t^2} = \frac{\partial \sigma}{\partial x}. \quad (12.1)$$

Two simplest models of viscoelastic behaviour are used – the Voigt and the Maxwell models. Let us write the corresponding rheological equations:

Voigt model $\sigma(t) = E\varepsilon(t) + \eta\dot{\varepsilon}(t).$ (12.2)

Maxwell model $\dot{\varepsilon}(t) = \frac{\dot{\sigma}(t)}{E} + \frac{\sigma(t)}{\eta}.$ (12.3)

Substituting (12.2) and (12.3) into (12.1) gives corresponding wave equations

Voigt: $\rho \frac{\partial^2 u}{\partial t^2} = E \frac{\partial^2 u}{\partial x^2} + \eta \frac{\partial^3 u}{\partial x^2 \partial t} \rightarrow \frac{1}{(v_{ph}^o)^2} \frac{\partial^2 u}{\partial t^2} - \alpha \frac{\partial^3 u}{\partial x^2 \partial t} = \frac{\partial^2 u}{\partial x^2}, \quad (v_{ph}^o)^2 = \frac{E}{\rho}, \quad \alpha = \frac{\eta}{E},$ (12.4)

Maxwell: $\frac{\rho}{E} \frac{\partial^3 u}{\partial t^3} + \frac{\rho}{\eta} \frac{\partial^2 u}{\partial t^2} = \frac{\partial^3 u}{\partial x^2 \partial t} \rightarrow \frac{\partial^2 u}{\partial t^2} + \frac{1}{\alpha} \frac{\partial u}{\partial t} = (v_{ph}^o)^2 \frac{\partial^2 u}{\partial x^2}.$ (12.5)

Equations (12.4),(12.5) have the solution in the form of harmonic one-dimensional waves

$$u(x,t) = A e^{-\gamma x - i(kx - \omega t)} \quad (12.6)$$

with the constant amplitude A and depending nonlinearly on frequency wave number $k(\omega)$ and attenuation coefficient γ :

Voigt: $(v_{ph})^2 = \frac{2(v_{ph}^o)^2}{(\alpha\omega)^2} [1 + (\alpha\omega)^2] \left[\sqrt{1 + (\alpha\omega)^2} - 1 \right], \quad \gamma = \frac{1}{\alpha v_{ph}^o} \frac{\alpha\omega}{\sqrt{2} \sqrt{1 + (\alpha\omega)^2}} \left[\sqrt{1 + (\alpha\omega)^2} - 1 \right],$

Maxwell: $(v_{ph})^2 = 2(v_{ph}^o)^2 \left/ \left[\sqrt{1 + \frac{1}{(\alpha\omega)^2}} + 1 \right] \right., \quad \gamma = \frac{1}{\alpha v_{ph}^o} \frac{\alpha\omega}{\sqrt{2}} \sqrt{\sqrt{1 + \frac{1}{(\alpha\omega)^2}} - 1}.$

Last equations (first and third) can be meant as dispersion equations. They show that **waves are dispersive** ones. Also, presence of attenuation coefficients (second and fourth) testifies that **waves are attenuating**.

These two novel facts distinguish first of all the viscoelastic waves from the corresponding elastic waves.

If to evaluate the group velocity by the Rayleigh formula

$$v_{gr} = v_{ph} / \left[1 - \left(\omega / v_{ph} \right) \left(dv_{ph} / d\omega \right) \right],$$

then the next formulas will hold be for the models in hand

$$\text{Voigt: } v_{gr} = 2v_{ph} \frac{1 + (\alpha\omega)^2}{\left[3 + (\alpha\omega)^2 - \sqrt{1 + (\alpha\omega)^2} \right]}, \quad \text{Maxwell: } v_{gr} = 2v_{ph} \frac{1}{\left[1 + \left(1 / \sqrt{1 + (\alpha\omega)^2} \right) \right]}.$$

Figs.16.1 and 16.2 show plots of dependence of the phase velocity, attenuation coefficient, and group velocity on frequency. The abscissa axis corresponds to the non-dimensional quantity $\alpha\omega$, the ordinate axis corresponds to the non-dimensional quantities v_{ph} / v_{ph}^0 , $\gamma\alpha v_{ph}^0$, v_{gr} / v_{ph}^0 . The upper plot corresponds to v_{gr} / v_{ph}^0 , the middle - v_{ph} / v_{ph}^0 , the lower - $\gamma\alpha v_{ph}^0$.

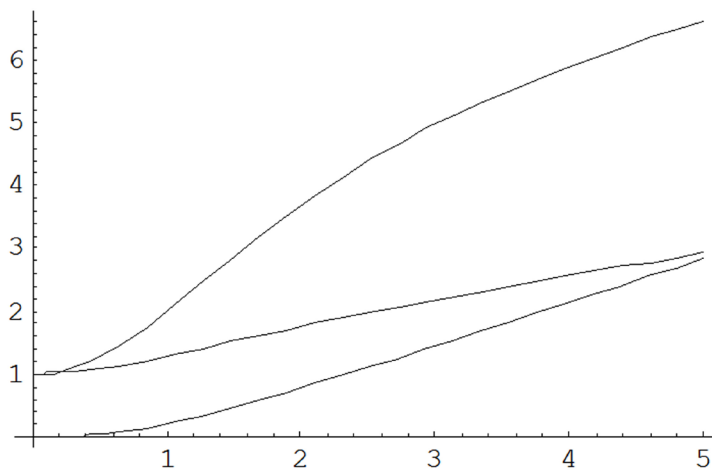

Fig.12.1. Dependence of reduced phase velocity, attenuation coefficient, and group velocity v_{ph} / v_{ph}^0 , $\gamma\alpha v_{ph}^0$, v_{gr} / v_{ph}^0 on reduced frequency $\alpha\omega$ for the Voigt model

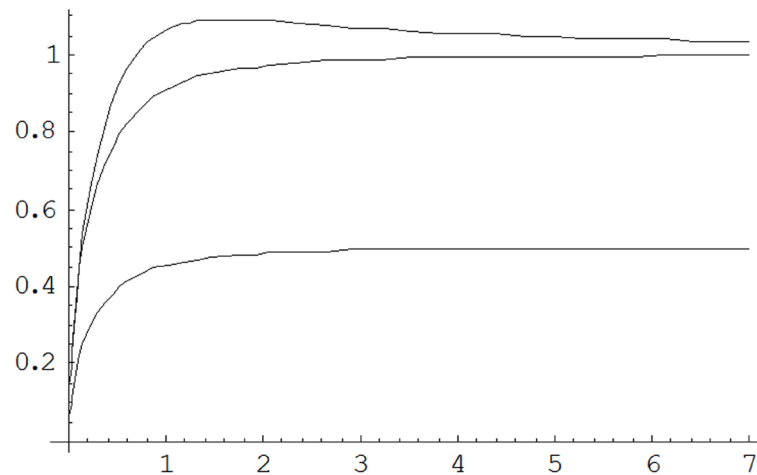

Fig.12.2. Dependence of reduced phase velocity, attenuation coefficient, and group velocity v_{ph}/v_{ph}^o , $\gamma\alpha v_{ph}^o$, v_{gr}/v_{ph}^o on reduced frequency $\alpha\omega$ for the Maxwell model

Note 12.1. Both figures should be commented in the way that both used models are the degenerated ones and give in some cases wrong description. But the main wave viscoelastic effects – the dispersion and attenuation – they describe correctly.

Consider now the more complicate structural model – the model of two-phase mixture and apply the general principle of constructing of the basic system of equations of the theory of viscoelasticity. It consists in the change in a basic system of the classical theory of elasticity of all elastic constants by viscoelastic operators. So, let us assume that a basic system of equations for elastic solid mixtures is given. The problem of a theory constructing for viscoelastic mixtures offers now as the problem of a transition from the set of elastic constants to the set of integral viscoelastic operators.

Note 12.2. But it is necessary to fix two features of our approach. The first one consists in that just the waves will be studied in such mixtures. The second is concerned with that this theory in its real applications and numerical computer evaluations is applied to composite materials.

Firstly, viscoelastic waves were studied from 70s. The pioneer publication on viscoelastic waves in mixtures was done in (Bedford, A & Stern M 1970). Here, for analysis of the fibrous one-directional composite material with viscoelastic deformed matrix the one-dimensional shear mixture theory was used.

One of the first experimental works on waves in viscoelastic composites was offered in (Sutherland, HJ & Calvit, HH 1974). Plane waves in two fibrous composite materials with the viscoelastic matrix (Solitan 113) and two types of fibers (nylon 66 and glass) were studied. Plots of dependence of phase velocities and wave attenuation versus frequency were obtained. Theoretical curves have been built according to two models: effective moduli and one-dimensional shear mixture. The question about a complex moduli representation and following work with them was discussed.

One can say that features of a wave picture in viscoelastic materials were studied experimentally more detailed than theoretically.

The second of above mentioned features is displayed in that usually both components in two-component composite materials are very seldom viscoelastic. For example, real composites manufactured on the base of an epoxide or other rosins (these rosins form the matrix of a composite) are armed by such fillers, which are deformed purely elastically. Therefore, only one component is deformed viscoelastic. That has a consequence in the features of modeling viscoelastic composites.

Let us consider two-phase composite, phases of which are isotropic. The first component (filler) is assumed to be elastic and is characterized by two Lamé moduli λ_f, μ_f , the density ρ_f , and the volume concentration c_f . The second component (matrix) is assumed to be viscoelastic, and is characterized by two viscoelastic operators

$$\bar{\lambda}_m \equiv \lambda_m^o (1 - \lambda_m^*), \bar{\mu}_m \equiv \mu_m^o (1 - \mu_m^*), \quad (12.7)$$

$$\lambda_m^* \cdot u(x, t) \equiv \int_0^t L(t - \tau) u(x, \tau) d\tau, \quad \mu_m^* \cdot u(x, t) \equiv \int_0^t M(t - \tau) u(x, \tau) d\tau,$$

difference kernels L, M of integral operators have the mechanical sense of relaxation rate; λ_m^o, μ_m^o are the instantaneous Lamé moduli. The density ρ_m and the volume concentration c_m ($c_f + c_m = 1$) are assumed to be constant.

Suppose additionally that the matrix displays a creep property only by shear deformations, and by volume deformations it deforms elastic.

Note 12.3. Such behaviour is characteristic of many polymer and not polymer materials, which are used as a matrix in the composite manufacturing.

This assumption permits to represent two operators $\bar{\lambda}_m, \bar{\mu}_m$ with the aim one operator only. Let us demonstrate how to use this fact in an analysis of the viscoelastic plane wave in two-phase mixture. Let us go from the matrix Lamé moduli to Young modulus E_m and bulk modulus k_m . Also, let us state that specific representation of an operator analogue of Young modulus is known from the creep experiments

$$\bar{E}_m = E_m^o (1 + \gamma E_m^*). \quad (12.8)$$

The creep of many engineering materials is described with a sufficient accuracy by the fractional-exponential operators, using of which in a creep theory is linked with the Rabotnov name. Therefore, we will use such an operator representation E_m^* by fractional-exponential operator in its traditional form

$$E_m^* = \hat{E}_\alpha(-\kappa). \quad (12.9)$$

The assumption about elasticity of volume deformation is now transformed in the statement that bulk modulus is purely elastic (let us denote it later by k_m^o) and that all other deformations are expressed through it and the operator \bar{E}_m . This operator involves 4 parameters: instantaneous Young modulus E_m^o , rate relaxation modulus γ , and two parameters α, κ from (12.9). The operator analogues $\bar{\lambda}_m, \bar{\mu}_m$ of Lamé moduli can now be presented through operator (12.9)

$$\bar{\lambda}_m = \lambda_m^o \left[1 - \frac{\gamma(1-2\nu_m^o)}{2\nu_m^o(1+\nu_m^o)} \hat{E}_\alpha \left(-\kappa - \frac{\gamma(1-2\nu_m^o)}{2(1+\nu_m^o)} \right) \right], \tag{12.10}$$

$$\bar{\mu}_m = \mu_m^o \left[1 - \frac{3\gamma(1-2\nu_m^o)}{2(1+\nu_m^o)} \hat{E}_\alpha \left(-\kappa - \frac{\gamma(1-2\nu_m^o)}{2(1+\nu_m^o)} \right) \right], \tag{12.11}$$

where $\mu_m^o = \frac{E_m^o}{2(1+\nu_m^o)}$; $\lambda_m^o = \frac{\nu_m^o E_m^o}{2(1+\nu_m^o)(1-2\nu_m^o)}$; $\nu_m^o = \frac{1}{2} \left(1 - \frac{E_m^o}{3k_m^o} \right)$.

It is expedient to use the written above formulas in modeling the composite materials by mixture model, when formulas are known according to them the mixture moduli can be evaluated through component moduli. Such formulas exist, they are building according to the same principles and by the same assumptions that formulas for macroscopic constants, but they are not always sufficiently exact. Moreover, such formulas are limited by a consideration only regular or close to regular internal structures.

Note 12.4. Therefore, another way is possible - the way of a direct determination of viscoelastic moduli from some experiments, including experiments on the wave propagation. Then pure theoretical studies of viscoelastic waves becomes as if more important.

Please click the advert

STUDY FOR YOUR MASTER'S DEGREE

IN THE CRADLE OF SWEDISH ENGINEERING

Chalmers University of Technology conducts research and education in engineering and natural sciences, architecture, technology-related mathematical sciences and nautical sciences. Behind all that Chalmers accomplishes, the aim persists for contributing to a sustainable future – both nationally and globally.

Visit us on Chalmers.se or [Next Stop Chalmers](#) on facebook.



CHALMERS
UNIVERSITY OF TECHNOLOGY

At the end of this fragment, remark that the viscoelastic dispersion of waves is insufficiently investigated. Especially when it is displayed simultaneously with the so-called geometrical dispersion.

Let us start with **the study of plane transverse horizontal polarized waves** and, in particular, the dependence of phase velocities and cut off frequency on viscoelastic properties of a material as well as the amplitude attenuation (decreasing).

Choose for describing such wave propagation the system of type, in which the inertial interaction will be neglected (that is, $\rho_{12} = 0$ is assumed). Use also the principle of constructing of the visco-elasticity theory (Volterra principle), when elastic constants are changed on viscoelastic operators.

Then propagation of viscoelastic waves will be described by the system of equations

$$\rho_{\alpha\alpha} \frac{\partial^2 u_m^{(\alpha)}}{\partial t^2} = \bar{\mu}_\alpha \frac{\partial^2 u_2^{(\alpha)}}{\partial x_1^2} + \bar{\mu}_3 \frac{\partial^2 u_2^{(\delta)}}{\partial x_1^2} - \bar{\beta} (u_2^{(\alpha)} - u_2^{(\delta)}), \quad (12.12)$$

where operators $\bar{\mu}_k, \bar{\beta}$ are assumed to be the form

$$\bar{\mu}_k \cdot q(x_1, t) \equiv \int_{-\infty}^t M_k(t-\tau) \frac{dq(x_1, \tau)}{d\tau} d\tau, \quad \bar{\beta} \cdot q(x_1, t) \equiv \int_{-\infty}^t B_k(t-\tau) \frac{dq(x_1, \tau)}{d\tau} d\tau. \quad (12.13)$$

The wave to be studied is harmonic. Introduce therefore the notation $u_2^{(\alpha)}(x_1, t) = \tilde{u}_2^{(\alpha)}(x_1) e^{-i\omega t}$.

Use also further the complex moduli

$$\mu_k^*(i\omega) = \mu_k'(\omega) + i\mu_k''(\omega) = |\mu_k^*| e^{i\varphi_k}, \quad \beta^*(i\omega) = \beta'(\omega) + i\beta''(\omega) = |\beta^*| e^{i\tilde{\varphi}}.$$

Here, $\mu_k'(\omega), \mu_k''(\omega)$ and $\beta'(\omega), \beta''(\omega)$ are **the store moduli** and **the loss moduli** of shear coefficients and the shear interface interaction coefficient, respectively

$$\mu_k'(\omega) = M_k^o + \omega \int_0^\infty \sin \omega\tau \hat{M}_k(\tau) d\tau, \quad \mu_k''(\omega) = \omega \int_0^\infty \cos \omega\tau \hat{M}_k(\tau) d\tau,$$

$$\beta'(\omega) = B^o + \omega \int_0^\infty \sin \omega\tau \hat{B}(\tau) d\tau, \quad \beta''(\omega) = \omega \int_0^\infty \cos \omega\tau \hat{B}(\tau) d\tau,$$

$$M_k(t) = M_k^o + \hat{M}_k(t), \quad \hat{M}_k(t) \xrightarrow{t \rightarrow \infty} 0; \quad B(t) = B^o + \hat{B}(t), \quad \hat{B}(t) \xrightarrow{t \rightarrow \infty} 0,$$

loss tangents are expressed by formulas $\tan \varphi_k = \frac{\mu_k''(\omega)}{\mu_k'(\omega)}$, $\tan \tilde{\varphi} = \frac{\beta''(\omega)}{\beta'(\omega)}$.

With allowance for the shown formulas, system (12.12) can be written in the simpler form

$$\left(\mu_\alpha^*(i\omega) \frac{d^2}{dx_1^2} - \beta^*(i\omega) - \rho_{\alpha\alpha} \right) \tilde{u}_2^{(\alpha)} + \left(\mu_3^*(i\omega) \frac{d^2}{dx_1^2} + \beta^*(i\omega) \right) \tilde{u}_2^{(\delta)} = 0. \quad (12.14)$$

The system (12.14) distinguishes from equations for elastic waves by only formal writing of coefficients. Therefore, the solution for elastic harmonic waves can be used. For this purpose, it is necessary only to make in corresponding formulas according to the Volterra principle such a substitution $\mu_k \rightarrow |\mu_k^*| e^{i\varphi_k}$, $\beta \rightarrow |\beta^*| e^{i\tilde{\varphi}}$.

On next step the method of linearization with respect to loss tangent should be used. The method is based on the assumption that loss tangents are small and therefore they can be substituted by equivalent small arguments. As a result, complex moduli will be written in the simpler form

$$\tan \varphi_k \approx \varphi_k, \tan \tilde{\varphi} \approx \tilde{\varphi} \rightarrow \mu_k'' \approx \mu_k' \varphi_k, \beta'' \approx \beta' \tilde{\varphi}.$$

Let us limit the analysis to small frequencies (or long waves), when the microstructure is displayed slightly and the geometrical dispersion is small.

For elastic waves, the solution becomes in simpler form comparing to the general case form

$$\frac{k_1^2}{\omega^2} = \frac{1}{(v_{ph}^{(1)})^2} = \frac{\rho_{11} + \rho_{22}}{\mu_\Sigma} - \frac{\omega^2}{\beta} \left\{ \frac{\rho_{11} + \rho_{22}}{\mu_\Sigma} (\mu_1 \rho_{22} + \mu_2 \rho_{11}) - \rho_{11} \rho_{22} - \left(\frac{\rho_{11} + \rho_{22}}{\mu_\Sigma} \right)^2 (\mu_1 \mu_2 - \mu_3^2) \right\}, \quad (12.15)$$

$$\frac{k_2^2}{\omega^2} = \frac{1}{(v_{ph}^{(2)})^2} = -\beta \frac{\mu_\Sigma}{\mu_1 \mu_2 - \mu_3^2} + \omega^2 \frac{\mu_1 \rho_{22} + \mu_2 \rho_{11}}{\mu_\Sigma}, \quad \mu_\Sigma = \mu_1 + \mu_2 + 2\mu_3. \quad (12.16)$$

The first summand on right side in expression (12.15) for **the first mode phase velocity is the constant quantity** for an elastic mixture and it gives the value of a phase velocity, which is calculated by the formula from the effective moduli theory

$$I = \frac{\rho_{11} + \rho_{22}}{\mu_1 + \mu_2 + 2\mu_3} = \frac{1}{(v_{ph}^{eff})^2}.$$

The second summand gives the gain, which decreases the phase velocity with frequency raising and which determines the geometrical dispersion.

The second mode with small frequencies does not propagate generally in the form of a free harmonic wave. It is the attenuated exponential wave. Purely formally, the wave number of the second mode should be the imaginary number. And it occurs, when in this formula moduli of real materials are substituted.

Now, use the Volterra principle and write the basic part in expression for a wave number (12.15) with taking into account of all the assumed here restrictions

$$I^{visc} = \left(\frac{k_1^{visc}}{\omega} \right)^2 = \frac{\rho}{S'_\mu (1 + \tilde{\varphi})} - i \frac{\rho \tilde{\varphi}}{S'_\mu (1 + \tilde{\varphi})}. \quad (12.17)$$

$$\rho = \rho_{11} + \rho_{22}, \quad S'_\mu = \mu'_1 + \mu'_2 + 2\mu'_3, \quad \mu'_1 \varphi_1 + \mu'_2 \varphi_2 + 2\mu'_3 \varphi_3 \approx S'_\mu \tilde{\varphi}.$$

The presence in (12.17) of an imaginary part testifies that the wave number in a viscoelastic mixture v_{ph}^{visc} in contrast to the same wave number in an elastic medium is the complex-valued quantity $k_1^{visc} = k_1^{visc} + ik_1''^{visc}$. Its real part determines the phase velocity $(\omega/k_1^{visc}) = v_{ph}^{visc}$; the imaginary part determines the attenuation. The first mode of a plane transverse polarized harmonic wave should be presented as follows

$$u_2^{(1)visc}(x_1, t) = u_2^{o(1)visc} e^{k_1''^{visc} x_1} e^{i(k_1^{visc} x_1 - \omega t)}. \tag{12.18}$$

Now the second conclusion from formula (12.17) can be formulated:

since the sum of store moduli S'_μ depends on frequency and have the property to increase with frequency increasing, then the phase velocity in viscoelastic mixture increase with frequency.

Note 12.5. Such increasing is the characteristic attribute of viscoelastic dispersion. It is well-known that in contrast to the viscoelastic dispersion the geometrical dispersion decreases always the phase velocity by increasing frequency.

The more particular conclusion can be made using the particular viscoelastic modulus and particular formulas for calculating of physical constants of a mixture theory.

For example, let us calculate **the influence of viscoelastic properties of a mixture of materials on the cut off frequency of the second mode.**

Please click the advert





it's an **interesting** world

Get under the skin of it.

Graduate opportunities
Cheltenham | £24,945 + benefits

One of the UK's intelligence services, GCHQ's role is two-fold: to gather and analyse intelligence which helps shape Britain's response to global events, and, to provide technical advice for the protection of Government communication and information systems. In doing so, our specialists – in IT, internet, engineering, languages, information assurance, mathematics and intelligence – get well beneath the surface of global affairs. If you thought the world was an interesting place, you really ought to explore our world of work.

www.careersinbritishintelligence.co.uk

Applicants must be British citizens. GCHQ values diversity and welcomes applicants from all sections of the community. We want our workforce to reflect the diversity of our work.







www.careersinbritishintelligence.co.uk

The general formula for cut off frequency in the isotropic elastic mixture was discussed

$$\omega_{cut}^* = \sqrt{\frac{\beta(\rho_{11} + \rho_{22})}{\rho_{11}\rho_{22}}} . \quad (12.19)$$

Let us set the goal to apply the correspondence principle (Volterra principle) to formula (12.19). Choose also *the standard viscoelastic model*, in which the operator analog of Young modulus for the matrix of a composite material \bar{E}_m has the form

$$\bar{E}_m q(t) \equiv E_m^o \left[q(t) - \frac{E_m^o - H_m^o}{E_m^o n_m} \int_0^t e^{-\frac{t-\tau}{n_m}} q(\tau) d\tau \right] . \quad (12.20)$$

Here, E_m^o is the instantaneous modulus, H_m^o is the long-duration modulus, n_m is the relaxation time.

To calculate the coefficient of a shear interface interaction, use the formula, proposed for the layered material designed by alternating of two layers of constant thicknesses h_α and, respectively, constant volume concentrations $c_\alpha = (h_\alpha/\Delta)$, $\Delta = h_1 + h_2$

$$\beta = \frac{3\mu_2}{(c_2 + c_1(\mu_2/\mu_1))\Delta^2} . \quad (12.21)$$

Then the operator analogy of interaction coefficient (12.21) with the aim of general formulas and representation $B(t) = B^o + \hat{B}(t)$, $\hat{B}(t) \xrightarrow{t \rightarrow \infty} 0$ can be written as follows

$$B^o = \beta^o \left(1 - \frac{a}{\alpha} \right); \quad \hat{B}(t) = \beta^o \frac{a}{\alpha} e^{-at} . \quad (12.22)$$

$$\alpha = \frac{1}{n_m} + \gamma \frac{1 - 2\nu_2^o}{2(1 + \nu_2^o)} + \frac{3\gamma c_1 \mu_2}{2(1 + \nu_2^o)(c_1 \mu_1 + c_2 \mu_2)}, \quad a = \frac{3\gamma c_2 \mu_1}{2(1 + \nu_2^o)(c_1 \mu_1 + c_2 \mu_2)}, \quad \gamma = \frac{E_m^o - H_m^o}{E_m^o n_m} .$$

Use formulas $\beta^*(i\omega) = \beta'(\omega) + i\beta''(\omega) = |\beta^*| e^{i\hat{\varphi}}$ and write expressions for the store and loss moduli

$$\beta'(\omega) = \beta^o \frac{\alpha^2 \left(1 - \frac{a}{\alpha} \right) + \omega^2}{\alpha^2 + \omega^2}, \quad \beta''(\omega) = \beta^o \frac{\omega}{\alpha^2 + \omega^2}, \quad \tan \hat{\varphi} = \frac{a\omega}{\alpha^2 \left(1 - \frac{a}{\alpha} \right) + \omega^2} . \quad (12.23)$$

Note 12.10. The loss tangent can be put into some physical sense. It takes into account the retardation on the angle $\hat{\varphi}$ of harmonically changed pulse, which is transmitted from one phase of the mixture to other one, comparing to harmonic change of displacements in these phases. It follows from formula (12.23) that the loss tangent decreases with frequency increasing reciprocally proportional to frequency and tends asymptotically to zero. For sufficiently large frequencies, it is practically zero. The order of these frequencies depends first of all on the relaxation time n_m and the modulus defect γn_m .

Apply now the correspondence principle to formula (12.21). Then for the calculation of cut off frequency the equations

$$\omega^2 = \frac{\rho}{\rho_{11}\rho_{22}} \beta^*(i\omega) \text{ or } \omega^2 = \frac{\rho}{\rho_{11}\rho_{22}} \beta'(\omega), \quad \beta''(\omega) = 0. \quad (12.24)$$

can be obtained.

The second equation in (12.24) has only the zero trivial root, in return the first root can be written in the form

$$\omega^2 = (\omega_{cut}^o)^2 \frac{\alpha^2 \left(1 - \frac{a}{\alpha}\right) + \omega^2}{\alpha^2 + \omega^2} \quad (\omega_{cut}^o)^2 = \beta^o \frac{\rho}{\rho_{11}\rho_{22}}.$$

This equation has only one suitable root

$$(\omega_{cut}^{visc})^2 = (\omega_{cut}^o)^2 \left\{ \frac{1}{2} \left(1 - \frac{\alpha^2}{(\omega_{cut}^o)^2} \right) + \frac{1}{2} \sqrt{\left(1 + \frac{\alpha^2}{(\omega_{cut}^o)^2} \right)^2 - 4 \frac{a}{\alpha} \frac{\alpha^2}{(\omega_{cut}^o)^2}} \right\}.$$

Thus, the cut off frequency for the excited in a viscoelastic mixture plane transverse horizontal polarized harmonic wave will be displaced in the direction from its instantaneous (initial) value during the time sufficient for a displaying of viscoelastic properties of a mixture. Because the cut off frequency is one of the basic characteristics of the dispersion curves, the mentioned above effect can be shown by constructing the dispersion curves for different time of wave propagation.

Comments

To finish the analysis of waves within the framework of the theory of viscoelasticity, let us note that this theory seemed to be very promising, when it was being only proposed for material analysis.

Long ago Tacit has been mentioned

“omne ignorum pro magnifico est” – “all undiscovered seems to be majestic”.

The founders of this theory only won fame. The next followers were not so successful.

Next developing the theory showed that it should be understood as one fragment only of the very rich picture of material behaviour. Moreover, the analytical part of the theory of viscoelasticity was turned out not so productive as was expected and have small influence on the rich analytical part of the theory of elasticity.

So, **“tempora mutantur nos et mutamur in illis” – “times are changing and we are changing with them”** and actually the viscoelastic waves are of interest very seldom.

Further reading

1. Achenbach, JD & Reddy, DP 1967, 'Note on Wave Propagation in Linearly Viscoelastic Waves.' *ZAMP*, vol.18, pp. 141.
2. Arenz, RJ 1964, 'Uniaxial Wave Propagation in Realistic Viscoelastic Materials,' *J. Appl. Mech.*, vol. 31, pp. 17-24.
3. Bedford, A, Drumheller, DS & Sutherland, HJ 1976, 'On modelling the dynamics of composite materials,' In: Nemat-Nasser, S., *Mechanics Today*, vol. 3, Pergamon Press, New York, pp. 1-54.
4. Bedford, A & Drumheller, DS 1983, 'Theories of immiscible and structured mixtures,' *Int. J. Eng. Sci.*, vol. 21, no. 8, pp. 863-960.
5. Bedford, A & Stern M. 1970, 'On wave propagation in fiber-reinforced materials,' *J. Appl. Mech.*, vol. 37, no. 1, pp.8-14.
6. Bland, DR 1960, *The Theory of Linear Viscoelasticity*. Oxford University Press, Oxford.
7. Christensen, RM 1971, *Theory of Viscoelasticity. An Introduction*. Academic Press, New York.
8. Davies, RM 1956, *Stress waves in solids*, Surveys in mechanics, The GI Taylor 70th anniversary volume, Batchelor, GK & Davies, RM (eds), Cambridge Monographs on Mechanics and Applied Mathematics, Cambridge University Press.
9. Fischer, GMC & Gurtin, ME 1965, 'Wave propagation in the linear theory of viscoelasticity.' *Quart. J. Appl.Math.*, vol. 23, pp. 257-267.
10. Gross, B 1968, *Mathematical Structure of the Theories of Viscoelasticity*, Herrmann, Paris.
11. Knauss, WG 1968, 'Uniaxial Wave Propagation in a Viscoelastic Material Using measured Material Properties,' *J. Appl. Mech.*, vol. 35, pp. 449-452.
12. Rushchitsky, JJ 1982, 'Propagation of plane viscoelastic waves in the mixture of materials.' *Soviet Appl. Mech.*, 1982, vol. 18, no.1. - pp. 76-80.
13. Rushchitsky, JJ 1991, *Elements of the theory of mixtures*. Naukova Dumka, Kyiv. (in Russian)
14. Rushchitsky, JJ & Tsurpal, SI 1998, *Waves in Materials with the Microstructure*, SP Timoshenko Institute of Mechanics, Kiev. (In Ukrainian)
15. Sutherland, HJ & Calvit, HH 1974, 'A dynamic investigation of fiberreinforced viscoelastic materials. Experimental and theoretical analysis of pulse propagation in glass- and nylon- reinforced urethane filaments,' *Exp. Mech.*, no.8, pp. 304-310.
16. Valanis, KC 1965, 'Propagation and Attenuation of Waves in Linear Viscoelastic Solids.' *J. Math. Phys.*, vol. 44, pp. 227-235.

Questions

- 12.1. Compare the dispersion curves for the Voigt and Maxwell models. Comment the steady-state and nonsteady-state variants for dispersion curves.
- 12.2. Compare the plots of the attenuation coefficients for the Voigt and Maxwell models. Comment the steady-state and non steady-state variants for plots of the attenuation coefficients.
- 12.3. Compare the plots of the group velocity for the Voigt and Maxwell models. Comment the steady-state and nonsteady-state variants for plots of the group velocity.
- 12.4. Outline the advantage of the theory of averaged moduli in determination of parameters of viscoelastic deformation of composite materials.
- 12.5. Formulate the simplifications owing to introducing into description of viscoelastic waves by the method of small loss tangent.
- 12.6. Comment the new phenomenon for the cut off frequency: the shift to right of its initial value.

13 Thermoelastic waves. Basic models

Basic models. Main thermodynamical potentials. Linear constitutive equations. Full system of equations of the linear theory of thermoelasticity. Coupled and uncoupled system. Spherical harmonic and inharmonic waves within the uncoupled approach

The theory of thermoelasticity is studying the deformation processes in materials which interact with surrounding environment by means of the mechanical work of internal forces and the heat exchange. The basic novelty comparing with the theory of elasticity is introducing the temperature (the temperature field) and temperature (thermal) stresses additionally to the mechanical stresses.

The temperature field can change owing two factors: **the heat application and the process of deformation.**

Thus, the basic model of thermoelastic behaviour should include four fields: three fields utilized in models of elastic behaviour – **the kinematical vector field of displacements** $\vec{u} = \{u_k\}$, **the kinematical tensor field of strains** $\varepsilon = \{\varepsilon_{ik}\}$ and **the kinetic tensor field of stresses** $\sigma = \{\sigma_{ik}\}$ – and **the scalar field of temperature** T .

The coupling of all the fields is carried out on the base of the thermodynamics of irreversible processes (see chapter 2).

As applied to the thermoelastic deformation processes, the thermodynamics of irreversible processes is based on three main assumptions:



HORIZONS UNIVERSITY



In Paris or Online
International programs taught by professors and professionals from all over the world

- BBA in Global Business
- MBA in International Management / International Marketing
- DBA in International Business / International Management
- MA in International Education
- MA in Cross-Cultural Communication
- MA in Foreign Languages

Innovative – Practical – Flexible – Affordable

Visit: www.HorizonsUniversity.org
Write: Admissions@horizonsuniversity.org
Call: 01.42.77.20.66

www.HorizonsUniversity.org

Please click the advert

Assumption 1. The entropy S is changed according to the formula

$$dS = \frac{dQ}{T} + dS^*,$$

where Q is the heat, S^* is the entropy caused by an irreversible process.

Assumption 2. The equilibrium state is formed in the macroscopically small parts of the body (formed locally), which is equivalent to the statement that thermodynamical functions are the single-valued functions of thermodynamical parameters. The first two thermodynamic laws are written as follows

$$-q_{k,k} = T\dot{S} = \dot{U} - \sigma_{im}\dot{\varepsilon}_{im},$$

where $\vec{q} = \{q_{ik}\}$ is the heat flux volume density, U is the internal energy volume density.

Assumption 3. The linking the heat flux and the temperature gradient **Fourier law** is valid

$$\vec{q} = -\lambda_q \text{grad } T,$$

$q_k = -\lambda_q T_{,k}$ (isotropic case), $q_i = -\lambda_{ik} T_{,k}$ (anisotropic case).

Note 13.1. The Fourier law is linear and assumes the infinite velocity of heat propagation. It is refined for the finite velocity $q_k = -\lambda_q T_{,k} - \tau \dot{q}_k$, where τ is called the heat flux relaxation time. The value of τ is very small for metals. For example, $\tau = 1 \cdot 10^{-11} s$ for aluminium.

Usually in the theory of thermoelasticity, two new (besides the thermodynamical function – **thermodynamical potential** in the form of internal energy $U = U(S, \varepsilon_{im})$, $\dot{U} = T\dot{S} + \sigma_{im}\dot{\varepsilon}_{im}$) thermodynamical functions – thermodynamical potentials are introduced:

the free energy $F = F(T, \varepsilon_{im})$

$$F = U - ST \text{ or } dF = -SdT + \sigma_{im}d\varepsilon_{im}, \quad (13.1)$$

the Gibbs thermodynamical potential $G = G(T, \sigma_{im})$

$$G = F - \sigma_{im}\varepsilon_{im} \text{ or } dG = -SdT - \varepsilon_{im}d\sigma_{im}. \quad (13.2)$$

Next relationships follow from the fact, that dU, dF, dG are the total differentials

$$(\partial U / \partial S) = T, \quad (\partial U / \partial \varepsilon_{im}) = \sigma_{im}, \quad (\partial F / \partial T) = -S, \quad (\partial F / \partial \varepsilon_{im}) = \sigma_{im},$$

$$(\partial G / \partial T) = -S, \quad (\partial G / \partial \sigma_{im}) = -\varepsilon_{im}.$$

Every thermodynamical potential determines fully all the thermodynamical parameters $T, S, \varepsilon, \sigma$.

Usually the free energy is chosen for demonstration of the procedure of constructing the constitutive relationships. The main idea consists in representation of the function F in the form of Taylor series in the neighbourhood of natural state $\varepsilon_{mn} = 0, T = T_o$. The linear equations are obtained by preserving the quadratically nonlinear terms like to the case of classical theory of elasticity

$$F = \frac{1}{2} c_{iklm}^T \varepsilon_{ik} \varepsilon_{lm} - \beta_{ik} \varepsilon_{ik} \theta - \frac{c_\varepsilon}{2T_o} \theta^2, \quad \theta = T - T_o,$$

where two families of isothermic physical constants are introduced

$$\frac{\partial^2 F(T_o, 0)}{\partial \varepsilon_{ik} \partial \varepsilon_{lm}} = c_{iklm}^T, \quad \frac{\partial^2 F(T_o, 0)}{\partial \varepsilon_{ik} \partial T} = -\beta_{ik}.$$

Definition 13.1. The process is called the **isothermic** one, when the heat exchange occurs under the constant temperature T_o .

Definition 13.2. The process is called the **adiabatic** one, when the heat exchange with surrounding environment is absent.

Then the constitutive equations are as follows

$$\sigma_{ik} = \frac{\partial F}{\partial \varepsilon_{ik}} = c_{iklm}^T \varepsilon_{lm} - \beta_{ik} \theta, \quad (13.3)$$

$$S = -\frac{\partial F}{\partial T} = \beta_{ik} \varepsilon_{ik} + c_\varepsilon \frac{\theta}{T_o}, \quad c_\varepsilon = T \left(\frac{\partial S}{\partial T} \right)_\varepsilon. \quad (13.4)$$

Note 13.2. Equations (13.4) are traditionally called **the Duhamel-Neumann relationships**, the quantity c_ε is called **the heat capacity for the constant deformation**.

Next step in forming the full system of equations consists in derivation of heat conduction equation (or equation for the heat penetration). It has the form

$$\lambda_{ik} \theta_{,ik} - c_\varepsilon \dot{\theta} - T_o \beta_{ik} \dot{\varepsilon}_{ik} = 0 \quad (\text{anisotropic case}), \quad (13.5)$$

$$\lambda_T T_{,kk} = c_\varepsilon \dot{T} + (3\lambda + 2\mu) T_o \beta_T \varepsilon_{kk} \quad (\text{isotropic case}). \quad (13.6)$$

Now the consisting of 16 unknown functions full system can be written. It includes 4 groups (the isotropic case is presented):

Group 1. Three equations of motion

$$\sigma_{ik,k} = \rho \ddot{u}_i. \quad (13.7)$$

Group 2. One heat conduction equation

$$T_{,kk} = \frac{1}{\kappa} \dot{T} + \eta \dot{\varepsilon}_{kk} \quad \left(\kappa = \frac{\lambda_T}{c_\varepsilon}, \eta = \frac{(3\lambda + 2\mu)T_o \beta_T}{\lambda_T} \right), \quad (13.8)$$

where new constant κ is called **the thermal diffusivity**.

Group 3. Six constitutive equations

$$\sigma_{ik} = 2\mu \varepsilon_{ik} + \left[\lambda \varepsilon_{mm} - (3\lambda + 2\mu) \beta_T (T - T_o) \right] \delta_{ik}. \quad (13.9)$$

Group 4. Six Cauchy relationships

$$\varepsilon_{ik} = \frac{1}{2} (u_{i,k} + u_{k,i}). \quad (13.10)$$

Note 13.3. Constitutive equations (13.9) can be represented in the equivalent form

$$\varepsilon_{ik} = \frac{1+\nu}{E} \sigma_{ik} - \frac{\nu}{E} \sigma_{mm} \delta_{ik} + \beta_T (T - T_o) \delta_{ik},$$

from which follows that the full strain tensor consists of two parts:

Please click the advert

Nido

Luxurious accommodation

Central zone 1 & 2 locations

Meet hundreds of international students

BOOK NOW and get a £100 voucher from voucherexpress

Nido Student Living - London

Visit www.NidoStudentLiving.com/Bookboon for more info.

+44 (0)20 3102 1060

Part 1. The strain tensor $\varepsilon_{ik} = \frac{1+\nu}{E}\sigma_{ik} - \frac{\nu}{E}\sigma_{mm}\delta_{ik}$, components of which corresponds to the Hooke elastic law.

Part 2. The spherical strain tensor $\varepsilon_{mm} = \beta_T(T - T_o)$, which corresponds to the pure thermal expansion of the material when temperature being increased on $T - T_o$.

The initial and boundary conditions on the boundary B can be written, for example, in the form:

$$u_k(x_1, x_2, x_3, 0) = \widehat{u}_k(x_1, x_2, x_3), \quad \dot{u}_k(x_1, x_2, x_3, 0) = \widehat{\dot{u}}_k(x_1, x_2, x_3), \quad T(x_1, x_2, x_3, 0) = \widehat{T}(x_1, x_2, x_3) \quad (13.11)$$

$$u_k(x_1, x_2, x_3, t) \Big|_{(x_1, x_2, x_3) \in B} = \widehat{u}_k(x_1, x_2, x_3, t), \quad T(x_1, x_2, x_3, t) \Big|_{(x_1, x_2, x_3) \in B} = \widehat{T}(x_1, x_2, x_3, t). \quad (13.12)$$

Equations (13.7) – (13.10) allow writing the analog of classical Lamé equations of theory of elasticity

$$\mu u_{k,mm} + (\lambda + \mu)u_{m,mk} - \gamma T_{,k} = \rho \ddot{u}_k, \quad \gamma = (3\lambda + 2\mu)\beta_T. \quad (13.13)$$

In the vector form, equations (13.13) and (13.6) are as follows

$$\mu \Delta \vec{u} + (\lambda + \mu) \text{grad div } \vec{u} - \gamma \text{grad } T = \rho \ddot{\vec{u}}, \quad (13.14)$$

$$\Delta T - \frac{1}{\kappa} \dot{T} - \eta \text{div } \vec{u} = 0. \quad (13.15)$$

Thus, equations (13.6), (13.13) or equations (13.14), (13.15) form the basic coupled system of the linear theory of thermo-elasticity.

Note 13.4. The coupling consists in that the change of temperature field in the body is accompanying by the thermoelastic deformation, and vice versa, the thermoelastic deformations owing to applied mechanical and temperature effects is accompanying by the change of temperature field.

In many cases the coupling effect is negligible. Then the term $T_o \beta_{ik} \dot{\varepsilon}_{ik}$ (or $\frac{(3\lambda + 2\mu)T_o \beta_T}{\lambda_T} \text{div } \vec{u}$)

in (13.6) can be omitted and then the next uncoupled system can be analyzed

$$\mu u_{k,mm} + (\lambda + \mu)u_{m,mk} - \gamma T_{,k} = \rho \ddot{u}_k, \quad (13.16)$$

$$T_{,kk} - \frac{1}{\kappa} \dot{T} = 0. \quad (13.17)$$

This system is very convenient by the fact that equation (13.17) doesn't depend on equations (13.16) and can be solved independently. Then the obtained function $T(x_1, x_2, x_3, t)$ should be substituted into equations (13.16), which are transformed in such a way into the classical Lamé equations with known external force $\vec{F} = (3\lambda + 2\mu)\beta_T \text{grad } T$.

Note 13.5. The elastic constants in theory of elasticity are determined for the adiabatic process, whereas the corresponding constants in theory of thermoelasticity are usually determined for the isothermic process.

Let us consider **some general properties** of the coupled (13.14), (13.15) and uncoupled basic system (13.16),(13.17).

Represent the displacement \vec{u} (like to as it is doing in the theory of elasticity, see chapter 5) in the form of potential and solenoidal parts

$$\vec{u} = \text{grad } \Phi + \text{rot } \vec{\Psi} \rightarrow u_k = \Phi_{,k} + \epsilon_{kmn} \Psi_{n,m}, \quad (13.18)$$

where Φ is the scalar potential, $\vec{\Psi}$ is the vector potential, ϵ_{ikm} is the Levi-Civita tensor.

Note 13.6. When the external force is acting, then the force vector must be also divided on the potential and solenoidal parts.

Then three different wave equations can be obtained:

wave equation for the volume (longitudinal) wave

$$\Delta \Phi - \frac{1}{(c'_{ph})^2} \ddot{\Phi} - \frac{\gamma}{\lambda + 2\mu} (T - T_o) = 0, \quad (13.19)$$

where $(c'_{ph})^2 = \frac{\lambda + 2\mu}{\rho}$ is the classical phase velocity of elastic volume waves;

wave equation for the shear (transverse) wave

$$\Delta \vec{\Psi} - \frac{1}{(c'_{ph})^2} \ddot{\vec{\Psi}} = 0, \quad (13.20)$$

where $(c'_{ph})^2 = \frac{\mu}{\rho}$ is the classical phase velocity of elastic shear waves;

equation for the temperature propagation

$$\Delta T - \frac{1}{\kappa} \dot{T} - \eta \Delta \Phi = 0. \quad (13.21)$$

Note 13.7. Sometimes the equation obtained from (13.18) and (13.20) by uniting both equations into one equation by means of elimination of temperature

$$\left[\left(\Delta - \frac{1}{(c'_{ph})^2} \frac{\partial^2}{\partial t^2} \right) \left(\Delta - \frac{1}{\kappa} \frac{\partial}{\partial t} \right) - \frac{\eta \gamma}{\rho (c'_{ph})^2} \Delta \frac{\partial}{\partial t} \right] \Phi = 0. \quad (13.22)$$

is called **the wave equation for longitudinal waves**.

In the similar way, sometimes the equation obtained from (13.18) and (13.20) by uniting both equations into one equation by means of elimination of potential Φ is called **the wave equation for temperature**

$$\left[\left(\Delta - \frac{1}{(c'_{ph})^2} \frac{\partial^2}{\partial t^2} \right) \left(\Delta - \frac{1}{\kappa} \frac{\partial}{\partial t} \right) - \frac{\gamma\eta}{\rho(c'_{ph})^2} \Delta \frac{\partial}{\partial t} \right] T = 0. \quad (13.23)$$

It should be mentioned that operators in equations (13.22), (13.23) are identical.

Thus, three wave equations for thermoelastic waves (13.19), (13.20), (13.21)

show some basic properties.

First, the propagation of the shear thermoelastic waves is identical with corresponding elastic waves; both waves propagate with the identical constant phase velocity. The presence of temperature field does not affect on shear waves.

Second, the volume waves and temperature field interact.

Third, despite of equation of temperature propagation (13.21) is parabolic type, the presence the term with describing the wave motion potential Φ , transforms the equation into (13.23), solution of which can have the wave character.

UNIVERSITY OF COPENHAGEN



Copenhagen Master of Excellence

Copenhagen Master of Excellence are two-year master degrees taught in English at one of Europe's leading universities

Come to Copenhagen - *and aspire!*

Apply now at
www.come.ku.dk

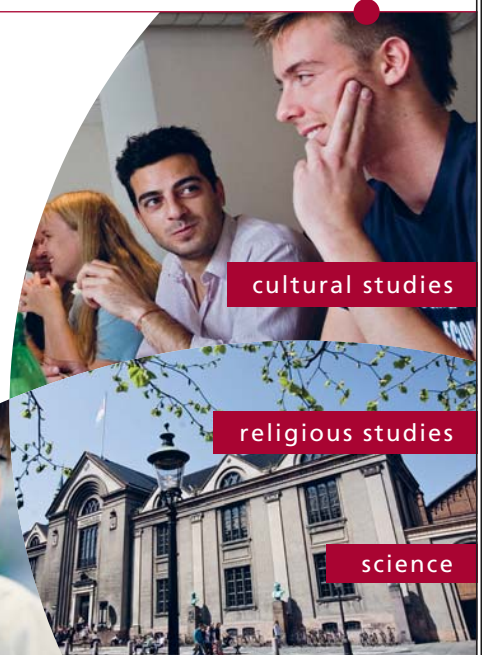

cultural studies

religious studies

science

Please click the advert

Download free ebooks at bookboon.com

Consider the case of uncoupled system (13.16),(13.17):

wave equation for the volume (longitudinal) wave

$$\Delta\Phi - \frac{1}{(c_{ph}^l)^2}\ddot{\Phi} - \frac{1+\nu}{1-\nu}\beta_T(T-T_o) = 0 \text{ or } \left(\Delta - \frac{1}{(c_{ph}^l)^2}\frac{\partial^2}{\partial t^2}\right)\left(\Delta - \frac{1}{\kappa}\frac{\partial}{\partial t}\right)\Phi = 0; \quad (13.24)$$

wave equation for the shear (transverse) wave

$$\Delta\bar{\Psi} - \frac{1}{(c_{ph}^l)^2}\ddot{\bar{\Psi}} = 0, \quad (13.25)$$

equation for the temperature propagation

$$\Delta T - \frac{1}{\kappa}\dot{T} = 0 \text{ or } \left(\Delta - \frac{1}{(c_{ph}^l)^2}\frac{\partial^2}{\partial t^2}\right)\left(\Delta - \frac{1}{\kappa}\frac{\partial}{\partial t}\right)T = 0. \quad (13.26)$$

Consider now the wave equation (13.24) and assume that the potential Φ is changing harmonically in time (the inducing the motion cause is harmonic in time)

$$\Phi(x_1, x_2, x_3, t) = \Phi^*(x_1, x_2, x_3)e^{i\omega t}. \quad (13.27)$$

Restrict next analysis to the spherical waves propagating in the radial direction of space from the heated spherical cavity and substitute (13.27) into equation (13.24)

$$\left(\Delta + \frac{\omega^2}{(c_{ph}^l)^2}\right)\left(\Delta + \frac{i\omega}{\kappa}\right)\Phi^* = 0. \quad (13.28)$$

The equation (13.28) has the solution in the form of waves

$$\Phi_{elas}^* = A_{elas}\frac{e^{i\omega R/v_{ph}^l}}{R} + B_{elas}\frac{e^{-i\omega R/v_{ph}^l}}{R}, \quad (13.29)$$

$$\Phi_{heat}^* = A_{heat}\frac{e^{iR\sqrt{i\omega/\kappa}}}{R} + B_{heat}\frac{e^{-iR\sqrt{i\omega/\kappa}}}{R}, \quad (13.30)$$

$$R = \sqrt{(x_1 - \xi_1)^2 + (x_2 - \xi_2)^2 + (x_3 - \xi_3)^2},$$

$$\left(\Delta + \frac{\omega^2}{(c_{ph}^l)^2}\right)\Phi_{elas}^* = 0, \quad \left(\Delta + \frac{i\omega}{\kappa}\right)\Phi_{heat}^* = 0, \quad \Phi^* = \Phi_{elas}^* + \Phi_{heat}^*. \quad (13.31)$$

The only solution in the form of divergence wave is available for the problem in hand (in the form of spherical waves propagating from the spherical cavity into infinity). Only this wave will satisfy the Sommerfeld conditions (radiation and finiteness conditions) for waves propagating into infinity. Then the available solution is as follows

$$\Phi^*(R, t) = \frac{A_{elas}}{R} \cos\left[-i\omega\left(t - R/v_{ph}^l\right)\right] + \frac{A_{heat}}{R} e^{-R\sqrt{\omega/2\kappa}} \cos\left[-i\omega\left(t - R/\sqrt{2\omega\kappa}\right)\right]. \quad (13.32)$$

Thus, the potential consists of two parts.

The first part corresponds to the pure elastic harmonic wave, which propagates with the constant phase velocity v_{ph}^l of the elastic volume wave, is not dispersive wave and does not attenuate.

The second part corresponds to the harmonic diffusional heat wave, propagating with the depending on frequency ω phase velocity $\sqrt{2\omega\kappa}$ (hence the wave becomes dispersive one) and attenuating, while being propagated (with increasing the distance from the cavity R), with the attenuation coefficient $\sqrt{\omega/2\kappa}$.

Note 13.8. It seems to be worthy to note that two relationships can be useful in the wave analysis.

$$\left(\Delta + \frac{\omega^2}{(c_{ph}^l)^2}\right) \Phi_{heat}^* = \frac{A_{elas}}{R} \left(\frac{i\omega}{\kappa} - \frac{\omega^2}{(c_{ph}^l)^2}\right) e^{-iR\frac{\omega}{c_{ph}^l}}, \quad \left(\Delta + \frac{i\omega}{\kappa}\right) \Phi_{elas}^* = -\frac{A_{heat}}{R} \left(\frac{i\omega}{\kappa} - \frac{\omega^2}{(c_{ph}^l)^2}\right) e^{-iR\sqrt{\frac{\omega}{2\kappa}}} \quad (13.33)$$

For example, the new expression for the thermal harmonic wave follows from (13.33)

$$T = \left[T_o - \left(\Delta + \frac{\omega^2}{(c_{ph}^l)^2}\right) \Phi_{elas}^* \right] e^{i\omega t} = \left[T_o e^{i\omega t} - \frac{A_{heat}}{R} \frac{c_{ph}^l \rho}{\gamma} \left(\frac{\omega^2}{(c_{ph}^l)^2} - \frac{i\omega}{\kappa}\right) e^{-i\left(\omega t - R\sqrt{\frac{\omega}{2\kappa}}\right)} \right]. \quad (13.34)$$

Consider finally equation (13.24) for the volume thermoelastic waves within the framework of the same as above uncoupled problem on the spherical wave propagating from the heated spherical cavity. But heating is now assumed to be not the periodic in time. The solution of the problem

can be represented as the sum of two unknown potentials

$$\Phi(x_1, x_2, x_3, t) = \Phi_{elas}(x_1, x_2, x_3, t) + \Phi_{heat}(x_1, x_2, x_3, t),$$

$$\left(\Delta - \frac{1}{(c_{ph}^l)^2} \frac{\partial^2}{\partial t^2}\right) \Phi_{elas} = 0, \quad \left(\Delta - \frac{1}{\kappa} \frac{\partial}{\partial t}\right) \Phi_{heat} = 0. \quad (13.35)$$

Assume the homogeneous initial conditions and apply to both equations the Laplace transform

$$L\{\Phi\} = \bar{\Phi}(x_1, x_2, x_3, p) = \int_0^{\infty} \Phi(x_1, x_2, x_3, t) e^{-pt} dt.$$

Then (13.35) are transformed into equations

$$\left(\Delta - \frac{p^2}{(c_{ph}^l)^2} \right) \bar{\Phi}_{elas} = 0, \quad \left(\Delta - \frac{p}{\kappa} \right) \bar{\Phi}_{heat} = 0,$$

the solutions of which can be easily written

$$\bar{\Phi}_{elas} = \bar{A}_{elas} \frac{e^{-pR/v_{ph}^l}}{R}, \quad \bar{\Phi}_{heat} = \bar{A}_{heat} \frac{e^{-iR\sqrt{p/\kappa}}}{R}, \quad (13.36)$$

$$R = \sqrt{(x_1 - \xi_1)^2 + (x_2 - \xi_2)^2 + (x_3 - \xi_3)^2},$$

Because the representation of transformed potentials in (13.36) consists of the product of two transformed by Laplace functions and with taking into account

$$L^{-1} \left\{ \frac{e^{-pR/v_{ph}^l}}{R} \right\} = \frac{1}{R} \delta \left(t - \frac{R}{v_{ph}^l} \right), \quad L^{-1} \left\{ \frac{e^{-iR\sqrt{p/\kappa}}}{R} \right\} = \frac{1}{2\sqrt{\pi\kappa t^3}} e^{-\frac{R^2}{4\pi\kappa t}},$$

then by the theorem on convolution the next expression for the potential can be obtained

$$\Phi(x_1, x_2, x_3, t) = \frac{1}{R} A_{elas}(t) \left(t - \frac{R}{v_{ph}^l} \right) + \int_0^t \frac{A_{heat}(t-\tau)}{\sqrt{4\pi\kappa\tau^3}} e^{-\frac{R^2}{4\pi\kappa\tau}} d\tau.$$

Please click the advert



**THE BEST MASTER
IN THE NETHERLANDS**

Master of Science in Management

Kickstart your career. Start your MSc in Management in September, graduate within 16 months and join 15,000 alumni from more than 80 countries.

Are you ready to take the challenge? Register for our MSc in Management Challenge and compete to win 1 of 3 partial-tuition revolving scholarships worth €10,000!

www.nyenrode.nl/msc



*Keuzegids Higher Education Masters 2012, in the category of business administration

NYENRODE
BUSINESS UNIVERSITEIT
A REWARD FOR LIFE

Despite of the fact that this problem is more general than the prior one (it does not assume the periodicity of heating the cavity surface), the main features of the prior wave problem are saved:

the solution consists of two parts, the first of which corresponds to the elastic wave (nondispersive with constant phase velocity and undamped) and the second of which has the diffusional character.

Comments

It is always noted in the classical monographs on thermoelasticity that the coupling the strain and temperature fields was been postulated by the founder of the theory of thermal stresses Duhamel as far back as in 1837. But the equation of thermal conductivity has been needed to be substantiated.

Next attempt to substantiate thermodynamically the equation of thermal conductivity has been done by Voigt (1910) and Jeffreys (1930). Only in 1960 Biot has been substantiated this equations on the base of thermodynamics of irreversible processes.

Actually the theory of thermoelasticity is quite turnkey division of mechanics of materials. It includes the basic relationships and differential equations, different methods of solving the basic problems are offered, the basic theorems are proven.

As it was formulated by classics of thermoelasticity, the main advantage of the theory of thermo- elasticity consists in its cognitive basis and generality.

But it seems to be worthy to note that taking into account the temperature field in wave problems is expedient not always. Each researcher must decide starting with the concrete situation. It can be formulated such an advice:

‘You should not swim with the stream and against the stream, but swim that way which you want’.

The last example in the chapter-lecture is based on application of the Laplace transform on time. This approach is very often used in the dynamical theory of thermoelasticity.

Further reading

1. Boley, BA & Weiner, HJ 1960, *Theory of thermal stresses*, John Wiley, New York - London.
2. Carslaw, HS & Jaeger, JC 1960, *Conduction of heat in solids*, Pergamon Press, London - New York.
3. de Groot, SR 1952, *Thermodynamics of Irreversible Processes*, North-Holland, Amsterdam.
4. Jones, DJ 1965, *Thermal stress analysis*, Pergamon Press, Oxford-Edinburg.
5. Kovalenko, AD 1970, *Theory of thermoelasticity*, Springer Verlag, Berlin-Heidelberg.
6. Nemat-Nasser, S 1975, ‘On nonequilibrium thermodynamics of continuum’. *Mechanics Today*, vol. 2, pp.94-158.
7. Nowacki, W 1962, *Thermoelasticity*, Pergamon Press, Oxford-New York.
8. Truesdell, C 1969, *Rational thermodynamics. A course of lectures on selected topics*, McGraw-Hill, New York.
9. Ziegler, H 1963, *Some extremum principles in irreversible thermodynamics with application to continuum mechanics*. Vol.6. in *Progress in Solid Mechanics*, Sneddon, IN & Hill, R (eds), North-Holland, Amsterdam.

Questions

- 13.1. It is well-known that the tensor fields of stresses and strains are the thermodynamical parameters, mutually complementary and form the ordered pair. Which field complements the temperature field?
- 13.2. See more in detail the Fick model of diffusion processes including the three different Fick assumptions (Fick laws). Compare with the Fourier model of heat conductivity.
- 13.3. Which model of thermoelasticity will be obtained when the internal energy will be expanded in Taylor series the third order terms including?
- 13.4. Is the fact of effect of temperature on the material deformation in the form of volume change only the fundamental property of heating process or it is the simple and convenient approximation of the real deformation of materials?
- 13.5. The adiabatic and isothermic conditions for determination of physical constants are distinguished in the theory of thermoelasticity. Is really this difference negligible small or not?
- 13.6. Try to explain the difference between couple and uncoupled theories of thermoelasticity using the difference in boundary conditions. In particular, consider the case when the force only is given on the boundary.
- 13.7. When the motion of volume thermoelastic harmonic wave consists of two different waves – the elastic with the stable harmonic profile and the dispersive damped diffusional wave, then which is the general picture of wave motion?

Destination MMU



Manchester
Metropolitan
University

MMU is proud to be one of the most popular universities in the UK. Some 34,000 students from all parts of the globe select from its curricula of over 1,000 courses and qualifications.

We are based in the dynamic yet conveniently compact city of Manchester, located at the heart of a sophisticated transport network including a major international airport on the outskirts. Parts of the campus are acclaimed for their architectural style and date back over 150 years, in direct contrast to our teaching style which is thoroughly modern, innovative and forward-thinking.

MMU offers undergraduate and postgraduate courses in the following subject areas:

- Art, Design & Performance
- Computing, Engineering & Technology
- Business & Management
- Science, Environmental Studies & Geography
- Law, Education & Psychology
- Food, Hospitality, Tourism & Leisure Studies
- Humanities & Social Science



For more details or an application form please contact MMU International.
email: international@mmu.ac.uk
telephone: +44 (0)161 247 1022
www.mmu.ac.uk/international

Please click the advert

14 Thermoelastic plane and spherical waves

Coupled system of thermoelasticity. New thermophysical constants. Main features on an example of the plane and spherical waves.

The theory of thermoelasticity is usually studying in two approaches: **coupled** and **uncoupled** thermoelasticity. The uncoupled thermoelasticity approach is characterized by absence of the coupling term in the equation of heat conductivity. Therefore this equation is solving independently and as result the temperature field in the body is determined.

Because the uncoupled thermoelasticity approach save the coupling term in the generalized Lamé equations, then in the next step the known temperature is substituted into the Lamé equations and these equations should be solved as the classical Lamé equations with the known right hand side. The simplest waves within the framework of the uncoupled thermoelasticity approach were expounded in the prior chapter-lecture.

Consider now the waves in **coupled thermoelasticity approach**. The starting point is the system of linear coupled theory of thermo-elasticity

$$\mu \Delta \vec{u} + (\lambda + \mu) \text{grad div } \vec{u} - \gamma \text{grad } T = \rho \ddot{\vec{u}}, \quad (14.1)$$

$$\Delta T - \frac{1}{\kappa} \dot{T} - \eta \text{div } \vec{u} = 0. \quad (14.2)$$

It is time at this place to discuss the problem of **new thermophysical constants**. As it can be seen immediately at equations (14.1),(14.2), they include three new constants γ, κ, η . But these constants are not the primary constants - they can be meant as the secondary constants $\gamma = (3\lambda + 2\mu)\beta_T$, $\kappa = \frac{\lambda_T}{c_\varepsilon}$, $\eta = \frac{(3\lambda + 2\mu)T_0\beta_T}{\lambda_T}$. The primary three for isotropic materials are as follows:

1. **The heat conductivity coefficient** (firstly appearing in the Fourier law of heat conductivity) λ_T with dimension $W \cdot m^{-1} \cdot K$.
2. **The thermal expansion coefficient** (firstly appearing in constitutive equations of thermoelastic deformation) β_T with dimension K^{-1} .
3. **The specific heat capacity** (firstly appearing in the entropy representation) c_ε with dimension $J \cdot kg^{-1} \cdot K^{-1}$.

Because in next analysis some plots will be constructed and full set of elastic and thermophysical constants of some real materials will be needed, then later the values of $\lambda_T, \beta_T, c_\varepsilon$ for these materials will be shown.

Consider now the plane waves (both the mechanical and heat nature) in the direction of abscissa axis (Chadwick, P & Sneddon, IN 1958; Chadwick, P 1960; Deresiewicz, H 1957).

Firstly assume that four unknown functions depend on two variables x, t only

$$u_1(x, t), u_2(x, t), u_3(x, t), T(x, t).$$

Suppose additionally that the periodic with frequency ω solutions are looking for

$$u_k(x, \omega, t) = \Re \{ \tilde{u}_k(x, \omega) e^{-i\omega t} \}, \quad T(x, \omega, t) = \Re \{ \tilde{T}(x, \omega) e^{-i\omega t} \}. \quad (14.3)$$

Note 14.1. This means that the next analysis is narrowed to the harmonic waves.

Then basic system (14.1),(14.2) is splitting into four wave equations

$$\left(\frac{\partial^2}{\partial x^2} - k_l^2 \right) \tilde{u}_1 - \frac{\gamma}{\rho (c_{ph}^l)^2} \frac{\partial T}{\partial x} = 0, \quad \left(\frac{\partial^2}{\partial x^2} - \frac{i\omega}{\kappa} \right) \tilde{T} - \frac{i\omega(3\lambda + 2\mu)T_o\beta_T}{\lambda_T} \frac{\partial \tilde{u}_1}{\partial x} = 0, \quad (14.4)$$

$$\left(\frac{\partial^2}{\partial x^2} - k_t^2 \right) \tilde{u}_2 = 0, \quad \left(\frac{\partial^2}{\partial x^2} - k_t^2 \right) \tilde{u}_3 = 0, \quad (14.5)$$

$$k_l^2 = \left[\omega^2 / (c_{ph}^l)^2 \right], \quad k_t^2 = \left[\omega^2 / (c_{ph}^t)^2 \right],$$

two first only of which are coupled.

If to exclude temperature T in two equations (14.4), then the corresponding to longitudinal plane waves equation can be written as follows

$$\left[\left(\frac{\partial^2}{\partial x^2} - \frac{1}{(c_{ph}^l)^2} \right) \left(\frac{\partial^2}{\partial x^2} - \frac{i\omega}{\kappa} \right) + \frac{i\omega\varepsilon}{\kappa} \right] \tilde{u}_1 = 0, \quad \varepsilon = \left[T_o\gamma^2 / \rho (c_{ph}^l)^2 c_\varepsilon \right]. \quad (14.6)$$

Thus, three equations (14.5),(14.6) form the system of linear wave equations for three plane waves – longitudinal, transverse vertical, and transverse horizontal.

Note 14.2. As follows from equations (14.5),(14.6), the longitudinal wave only will depend on the change of temperature field.

Owing to triviality of the wave equations for both types of transverse thermoelastic waves (they are identical with the corresponding elastic waves), **next analysis will be restricted to the longitudinal waves only.**

The equation (14.6) admits solutions $\tilde{u}_1 = u^o e^{ikx}$, $\tilde{T} = T^o e^{ikx}$, where u^o, T^o are the arbitrary constants. In this case, representation (14.3) becomes the form of harmonic wave

$$u_k(x, \omega, t) = \Re \{ u^o e^{i(kx - \omega t)} \}, \quad T(x, \omega, t) = \Re \{ T^o e^{i(kx - \omega t)} \} \quad (14.8)$$

with unknown wave number k .

The dispersion equation for determination of the wave number can be found by substituting wave representation (14.8) into equations (14.5),(14.6).

When to take into account the relationships

$$\frac{u^o}{T^o} = \frac{ik\gamma}{\rho v_{ph}'(k_l^2 - k^2)}, \quad \frac{T^o}{u^o} = -\frac{\omega k T_o \gamma}{\lambda_T \left(\frac{i\omega}{\kappa} - k^2 \right)},$$

then the dispersion equation becomes the form of biquadratic algebraic equation

$$k^4 - \left[k_l^2 + \frac{i\omega}{\kappa}(1 + \varepsilon) \right] k^2 + \frac{i\omega}{\kappa} k_l^2 = 0 \quad (14.9)$$

with roots

$$k_{1,2}^2 = \frac{1}{2} \left\{ k_l^2 + \frac{i\omega}{\kappa}(1 + \varepsilon) \pm \sqrt{\left[k_l^2 + \frac{i\omega}{\kappa}(1 + \varepsilon) \right]^2 - 4 \frac{i\omega}{\kappa} k_l^2} \right\}. \quad (14.10)$$

Note 14.3. When the coupling is absent (that is, $\varepsilon = 0$), then roots (14.10) becomes simpler $k_1 = k_l$, $k_2 = \sqrt{i\omega/\kappa}$. In this case the longitudinal thermoelastic wave coincides with the volume wave considered in the prior chapter-lecture.

In the general case, the wave of longitudinal displacement and the thermal wave will have some more complicate form

$$u_k(x, t) = \text{Re} \left\{ u^o e^{i(k_1 x - \omega t)} + \frac{ik_2 \gamma T^o}{\rho v_{ph}'(k_l^2 - k_2^2)} e^{i(k_2 x - \omega t)} \right\}, \quad (14.11)$$

$$T(x, t) = \text{Re} \left\{ T^o e^{i(k_2 x - \omega t)} - \frac{\omega k_1 T_o \gamma u^o}{\lambda_T \left(k_l^2 - \frac{i\omega}{\kappa} \right)} e^{i(k_1 x - \omega t)} \right\}. \quad (14.12)$$

Thus, the thermoelastic longitudinal displacement wave consists of two waves (it is superposition of two different waves). One wave is associated with the displacement wave, whereas the second one is associated with the corresponding thermal wave.

The temperature propagation has also the wave character and consists of two mentioned above waves, but with differing amplitudes. But both superposing waves are dispersive and will attenuate.

To check this statement, let us introduce new notations based on complexity of the wave numbers k_α (as it follows from the solution (14.10) of dispersion equation)

$$v_{ph}^{(\alpha)} = \frac{\omega}{\text{Re}\{k_\alpha\}}, \quad \tau_\alpha = \text{Im}\{k_\alpha\}.$$

Then formulas (14.11),(14.12) can be transformed to the form

$$u_k(x,t) = \text{Re} \left\{ u^o e^{-\tau_1 x} e^{-i \left(t - \frac{x}{v_{ph}^{(1)}} \right)} + \frac{ik_2 \gamma T^o}{\rho v_{ph}^l (k_1^2 - k_2^2)} e^{-\tau_2 x} e^{-i \omega \left(t - \frac{x}{v_{ph}^{(2)}} \right)} \right\}, \quad (14.13)$$

$$T(x,t) = \text{Re} \left\{ T^o e^{-\tau_2 x} e^{-i \left(t - \frac{x}{v_{ph}^{(2)}} \right)} - \frac{\omega k_1 T^o \gamma u^o}{\lambda_T \left(k_1^2 - \frac{i\omega}{\kappa} \right)} e^{-\tau_1 x} e^{-i \omega \left(t - \frac{x}{v_{ph}^{(1)}} \right)} \right\}. \quad (14.14)$$

Thus, in new formulas (14.14),(14.15), the components responsible for attenuation (including $e^{-\tau_\alpha x}$) and for propagating with dispersion (including $e^{-i\omega \left(t - \frac{x}{v_{ph}^{(\alpha)}} \right)}$) are marked out separately. Their presence means that both superposing waves are attenuating and dispersive ones.

Usually the limit case of coupling absence is considered and commented relative to waves (14.13), (14.14). For this reason, let us return to Note 14.3 and repeat the formulas $k_1 = k_l$, $k_2 = \sqrt{i\omega/\kappa}$.

They means that

$$v_{ph}^{(2)} = \frac{\omega}{\text{Re}\{k_\alpha\}} = \sqrt{2\kappa\omega}, \quad \tau_\alpha = \text{Im}\{k_\alpha\} = \sqrt{\omega/2\kappa}. \quad (14.15)$$

Thus, the uncoupled approach saves nevertheless the basic properties of the thermal wave – it is still dispersive and damped. This can be seen from the next two plots constructed for the real E - glass, utilized as fibers in manufacturing the composites.

Here $\beta_T = 5.0 \cdot 10^{-6} K^{-1}$, $c_\varepsilon = 0.197 W \cdot s \cdot kg^{-1} \cdot K^{-1}$, $3\lambda + 2\mu = 120 MPa$, $\kappa = \frac{(3\lambda + 2\mu)\beta_T}{c_\varepsilon}$.

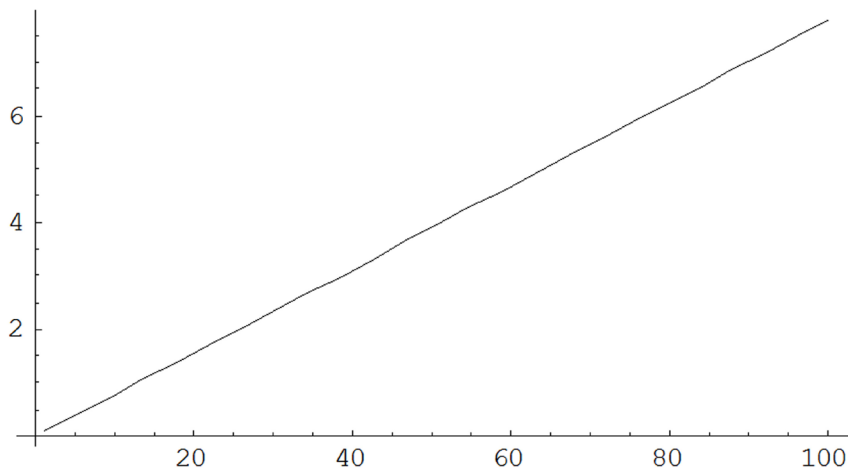

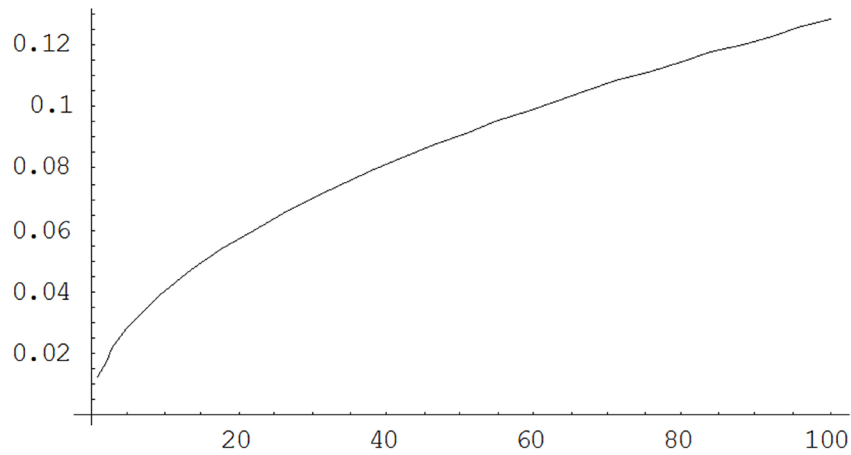

Fig.14.1. Dependence the phase velocity $\sqrt{2\kappa\omega}$ (in km/s) and attenuation coefficient $\sqrt{\omega/2\kappa}$ (in 1/m) on frequency [0;100MHz].

To analyze the complex-valued wave numbers k_1, k_2 or the real-valued phase velocities $v_{ph}^{(1)}, v_{ph}^{(2)}$ and attenuation coefficients τ_1, τ_2 , it seems to more convenient to introduce new denotations

$$\chi = (\omega/\omega^*), \quad \omega^* = \left[(v_{ph}^l)^2 / \kappa \right], \quad \zeta = (v_{ph}^l / \kappa) k.$$

Please click the advert



UPPSALA
UNIVERSITET

Develop the tools we need for Life Science Masters Degree in Bioinformatics

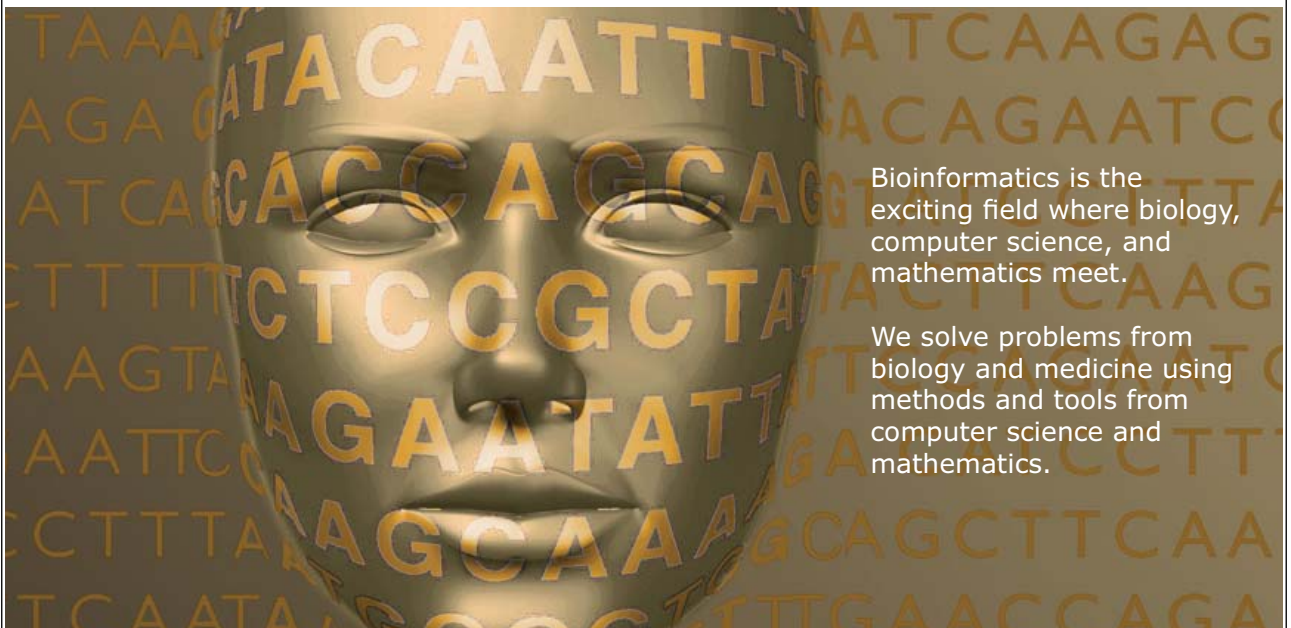

Bioinformatics is the exciting field where biology, computer science, and mathematics meet.

We solve problems from biology and medicine using methods and tools from computer science and mathematics.

Read more about this and our other international masters degree programmes at www.uu.se/master

Download free ebooks at bookboon.com

Note 14.4. The parameter ω^* is called the characteristic frequency for the material.

Then dispersion equation (14.9) can be written in the new form

$$\zeta^4 - [\chi^2 + i\chi(1 + \varepsilon)]\zeta^2 + i\chi^3 = 0. \quad (14.16)$$

Now two parameters χ, ε only are presented in equation (14.16). They are distinguished by that χ depends on frequency, whereas ε does not depend on frequency and is characterized by the elastic and thermophysical properties of the material. Below the known in thermoelasticity table is shown.

	aluminium	copper	steel	tin
v_{ph}^l (km/s)	6.32	4.36	5.80	2.14
ε	$3.56 \cdot 10^{-2}$	$1.68 \cdot 10^{-2}$	$1.14 \cdot 10^{-2}$	$7.33 \cdot 10^{-2}$
ω^* (Hz)	0.466 THz	0.173 THz	1.75 THz	0.191 THz
$\tau_1(\infty)$ (1/ μm)	1.31	0.329	1.72	3.27
ω_c (Hz)	98.0 THz	75.5 THz	99.5 THz	36.9 THz

Table 14.1. The values of basic thermoelastic parameters

Note 14.5. Two values for steel from Table 14.1 were refined in (Kovalenko, AD 1970).

Next assumption is smallness the newly introduced quantity χ . It is substantiated by that usual tests on waves are carried out in the ultrasound range [20 KHz; 1 GHz]. In this case $\omega \ll \omega^*$ and hence $\chi \ll 1$. The roots ζ_1, ζ_2 of equation (14.16) can be expanded into the power series relative to χ .

The relationships $\zeta_\alpha = v_{ph}^l \left(\frac{\chi}{v_{ph}^{(\alpha)}} + i \frac{\tau_\alpha}{\omega^*} \right)$ ($\alpha=1;2$) will be useful in this case. Some approximate values for phase velocities and attenuation coefficients can be evaluated from these series. In (Chadwick, P 1960) the formulas for quadratic approximation for phase velocities attenuation coefficients of the quasi-elastic wave and cubic approximation for the quasi-thermal wave are proposed

$$v_{ph}^{(1)} = v_{ph}^l \sqrt{1 + \varepsilon} \left[1 - \frac{\varepsilon(4 - 3\varepsilon)}{8(1 + \varepsilon)^4} \chi^2 \right], \quad \tau_1 = \frac{\omega^* \varepsilon^2}{2v_{ph}^l (1 + \varepsilon)^{5/2}} \chi^2, \quad v_{ph}^{(2)} = v_{ph}^l \sqrt{\frac{2\chi}{1 + \varepsilon}} \left[1 - \frac{\varepsilon}{2(1 + \varepsilon)^2} \chi + \frac{\varepsilon(4 + \varepsilon)}{8(1 + \varepsilon)^4} \chi^2 + \frac{\varepsilon(\varepsilon^2 - 20\varepsilon + 8)}{16(1 + \varepsilon)^6} \chi^3 \right],$$

$$\tau_2 = \frac{\omega^*}{v_{ph}^l} \sqrt{\frac{1}{2} \chi (1 + \varepsilon)} \left[1 - \frac{\varepsilon}{2(1 + \varepsilon)^2} \chi + \frac{\varepsilon(4 - \varepsilon)}{8(1 + \varepsilon)^4} \chi^2 + \frac{\varepsilon(\varepsilon^2 - 12\varepsilon + 8)}{16(1 + \varepsilon)^6} \chi^3 \right].$$

Next four plots show the dependence of four wave parameters $v_{ph}^{(\alpha)}, \tau_\alpha$ on the small values of χ . The material from Table 14.1 is chosen for computing – copper. The abscissa axis corresponds to values of quantity $\chi \in [0; 0.1]$, the ordinate axis for phase velocities corresponds to Km/s and for attenuation coefficients to $1/mm$.

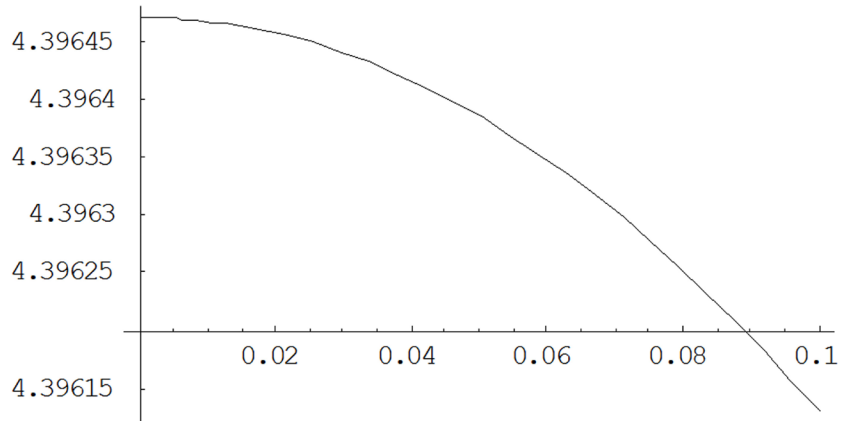

Fig.14.2. Dependence the phase velocity $v_{ph}^{(1)}$ (in km/s) of the quasi-elastic wave on small values of χ .

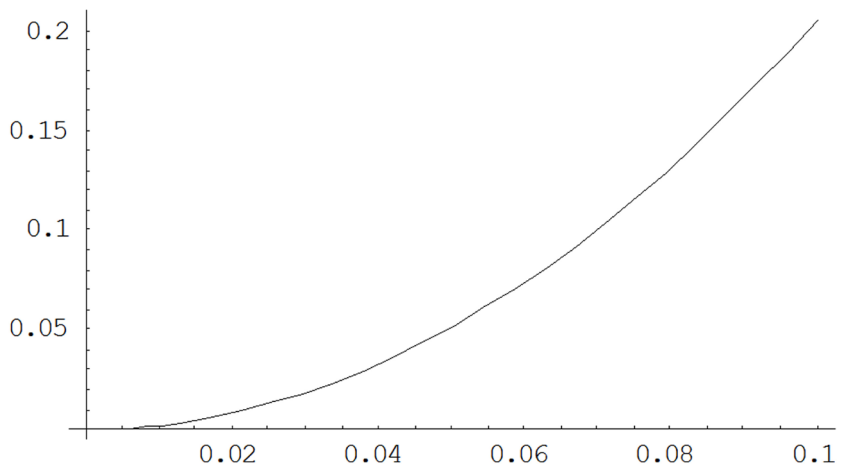

Fig.14.3. Dependence the attenuation coefficient τ_1 (in 1/mm) of quasi-elastic wave on small values of χ .

Note 14.6. The chosen range of changing $\chi \in [0; 0.1]$ is practically very broad for copper and corresponds to the frequency range with the upper limit 17.3 GHz, what means including the waves from the hypersound range.

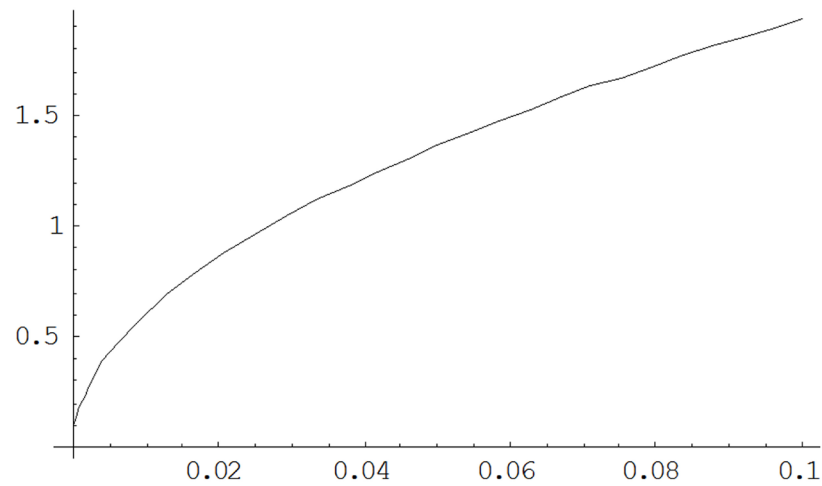

Fig.14.4. Dependence the phase velocity $v_{ph}^{(2)}$ (in km/s) of quasi-thermal wave on small values of χ .

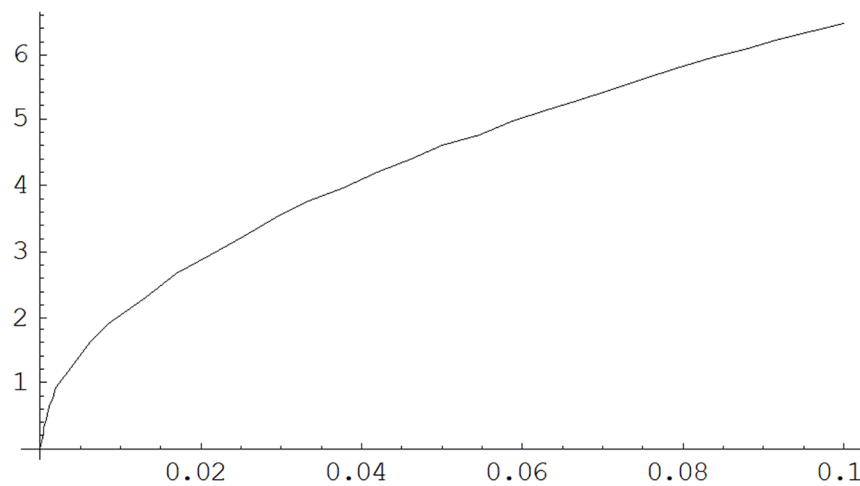

Fig.14.5. Dependence the attenuation coefficient τ_2 (in 1/mm) of quasi-thermal wave on small values of χ .

Thus, **the quasi-elastic wave is close to the classic elastic longitudinal wave but with small dispersion and small attenuation.** The phase velocity $v_{ph}^{(1)}$ is changed on 0.007% and can be assumed to be constant on interval $\chi \in [0; 0.1]$.

The attenuation coefficient τ_1 is changed from zero to 0.2 1/mm on interval $\chi \in [0.01; 0.1]$ and the wave should be considered as the slightly damping one.

The quasi-thermal wave is on the contrary essentially dispersive and damped one.

The phase velocity $v_{ph}^{(2)}$ is changed from zero to 2.0 km/s and can not be assumed to be constant on interval $\chi \in [0; 0.1]$. This second wave shows the strong dispersion.

The attenuation coefficient τ_2 is changed from zero to 6.0 1/mm on interval $\chi \in [0; 0.1]$ and the wave should be considered as the strong damping one.

It must be noted that the displacement wave (14.13) and the thermal wave (14.14) consist of two above mentioned waves – the quasi-elastic and the quasi-thermal ones. The degree of influence of the quasi-thermal wave on the displacement wave (14.13) and the quasi-elastic wave on the thermal wave (14.14) will depend on amplitude coefficients in representations

$$(14.13) ik_2 \gamma T^o / [\rho v_{ph}^l (k_1^2 - k_2^2)] \text{ and } (14.14) \omega k_1 T_o \gamma u^o / \left[\lambda_\tau \left(k_1^2 - \frac{i\omega}{\kappa} \right) \right].$$

Please click the advert

MÄLARDALEN UNIVERSITY SWEDEN

WELCOME TO OUR WORLD OF TEACHING!

INNOVATION, FLAT HIERARCHIES AND OPEN-MINDED PROFESSORS

STUDY IN SWEDEN – HOME OF THE NOBEL PRIZE

CLOSE COLLABORATION WITH FUTURE EMPLOYERS SUCH AS ABB AND ERICSSON

TAKE THE FAST TRACK

GIVE YOUR CAREER A HEAD START AT MÄLARDALEN UNIVERSITY
www.mdh.se

SASHA SHAHBAZI
LEFT IRAN FOR A MASTERS IN PRODUCT AND PROCESS DEVELOPMENT AND LOTS OF INNEBANDY
HE'LL TELL YOU ALL ABOUT IT AND ANSWER YOUR QUESTIONS AT MDUSTUDENT.COM

Download free ebooks at bookboon.com

Comments

This chapter-lecture follows the original publications (Chadwick, P & Sneddon, IN 1958; Deresiewicz, H 1957). It should be noted that they became so full and exhausting that many next books repeated the offered explanation. Such happens.

Thus, interaction of the strain field and the temperature field complicate the process of wave propagation. Independently on the fact of cause of deformations in a material – the mechanical force or the heating the material – the propagating displacement waves, for example, will consist of two different waves and the wave picture will be formed as the superposition of these two waves. Simultaneously with the displacement waves, the thermal wave will propagate. It consists also of the same two waves, but with differing amplitude factors. The thermal wave picture will be formed as the superposition of these two waves, too.

Further reading

1. Boley, BA & Weiner, HJ 1960, *Theory of thermal stresses*, John Wiley, New York - London.
2. Carslaw, HS & Jaeger, JC 1960, *Conduction of heat in solids*, Pergamon Press, London - New York.
3. Chadwick, P & Sneddon, IN 1958, 'Plane Waves in an Elastic Solid Conducting Heat'. *J. Mech. and Phys. Solids*, vol. 7, no. 1, pp. 3-13.
4. Chadwick, P 1960, *Thermoelasticity. The Dynamical Theory*. Progress in Solid Mechanics. North-Holland, Amsterdam.
5. de Groot, SR 1952, *Thermodynamics of Irreversible Processes*, North-Holland, Amsterdam.
6. Deresiewicz, H 1957, 'Plane Waves in a Thermoelastic Solid', *J. Acoust. Soc. Amer.*, vol. 29, pp. 204-210.
7. Jones, DJ 1965, *Thermal stress analysis*, Pergamon Press, Oxford-Edinburg.
8. Kovalenko, AD 1970, *Theory of thermoelasticity*, Springer Verlag, Berlin -Heidelberg.
9. Nowacki, W 1962, *Thermoelasticity*, Pergamon Press, Oxford-New York.
10. Tsui, T & Kraus, H 1965, 'Thermal stress wave propagation in hollow elastic spheres', *J. Acoust. Soc. Amer.*, vol. 37, no. 4, pp.730-737.

Questions

- 14.1. The coefficient β_T is called the coefficient of linear expansion. In which a way the used in description of volume waves coefficient of volume expansion is introducing?
- 14.2. Two approaches to constructing the theory of thermoelasticity are possible – the deductive one assumes the knowledge of the thermodynamical potential and the experimental one assumes the knowledge of the state laws. Comment and compare these approaches as applied to wave propagation.
- 14.3. Comment the difference between isothermic and adiabatic processes on an example of the volume expansion and volume wave propagation.
- 14.4. Write the most general law linked the heat flux and the temperature gradient and comment its effect on the basic wave equations.
- 14.5. Write the Beltrami equations for the linear thermoelasticity and corresponding wave equations.
- 14.6. Read the statement of the problem on thermal shock and comment it.
- 14.7. It is well-known that temperature in the linear approach is propagating with the infinite velocity. At the same time, the quasi-thermal wave is propagating with the finite phase velocity. Comment this seeming contradiction.

15 Elastoplastic waves. Classical models

Classical models of elastoplastic deformation. Conditions of plasticity, Tresca and Huber- Mises criteria. Simple and complex loading, unloading. Basic system of equations.

Let us start with the mention that for the most part of materials the basic and the first historically model is the model of elastic deformation. The model distinguishes the linearly and nonlinearly deformed materials. Two reasons for distinguishing can be shown here:

Reason 1. The formal reason – the linear model is essentially more simple in using and is quite right for small levels of deformations.

Reason 2. The physical reason – the nonlinear model describes the whole bouquet of important nonlinear effects in deformation process, which can not be neglected for non-small levels of deformations.

The primary good illustration gives the diagram of dependence “stress – strain” for standard tests on sample tension.

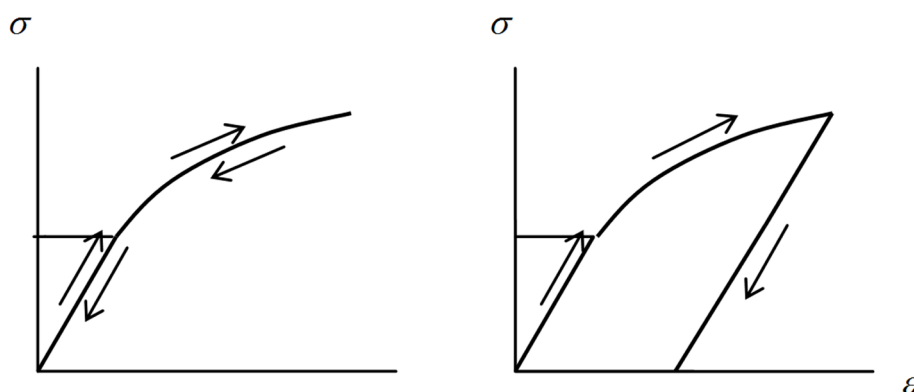

Fig. 15.1. The dependence $\sigma \sim \varepsilon$ for standard tests on sample tension.

The plots show identically the linear and the nonlinear parts of the loading diagram.

Definition 15.1. The value of stress σ^p , from which the linearity (the proportionality) of relationships $\sigma \sim \varepsilon$ is broken, is called **the proportionality limit**.

When the loading is finished and the unloading is started, then two fundamentally distinct possibilities exist.

The first possibility consists in that the loading diagram coincides with the unloading diagram. This case is shown on the left plot. The sample is returned into its initial state (shape) with finishing the unloading procedure.

Definition 15.2. Such materials are called the nonlinearly elastic materials.

In the case of second possibility, the unloading diagram is distinguishing from the loading diagram. It is shown on the right plot – this will be the straight line almost parallel to the linear part of loading diagram. When the unloading procedure is finishing, then the sample saves some **residual strain** and naturally the sample shape does not coincide with its initial shape.

Definition 15.3. Such materials are called the **elastoplastic materials**.

Definition 15.4. For many materials the proportionality limit σ^p is close to the **yield stress** σ^y or coincides with it. The yield stress is defined as the minimal value of the stress, when the plasticity property is manifested.

Note 15.1. The fundamental distinction between nonlinearly elastic and elastoplastic materials is reflecting in the character of constitutive equations.

For the nonlinearly elastic materials, the dependence between stresses and strains is one-valued – the existing in material strains permit to evaluate explicitly the stresses.

For the elastoplastic materials such one-valuedness is absent. While the strains in material being known, the existing in material stresses can be evaluated explicitly, when only the stress-strain history is known.

In the mathematical description, all the groups of basic equations of the nonlinear theory elasticity and theory of elastoplasticity are identical excluding the constitutive equations.

Please click the advert

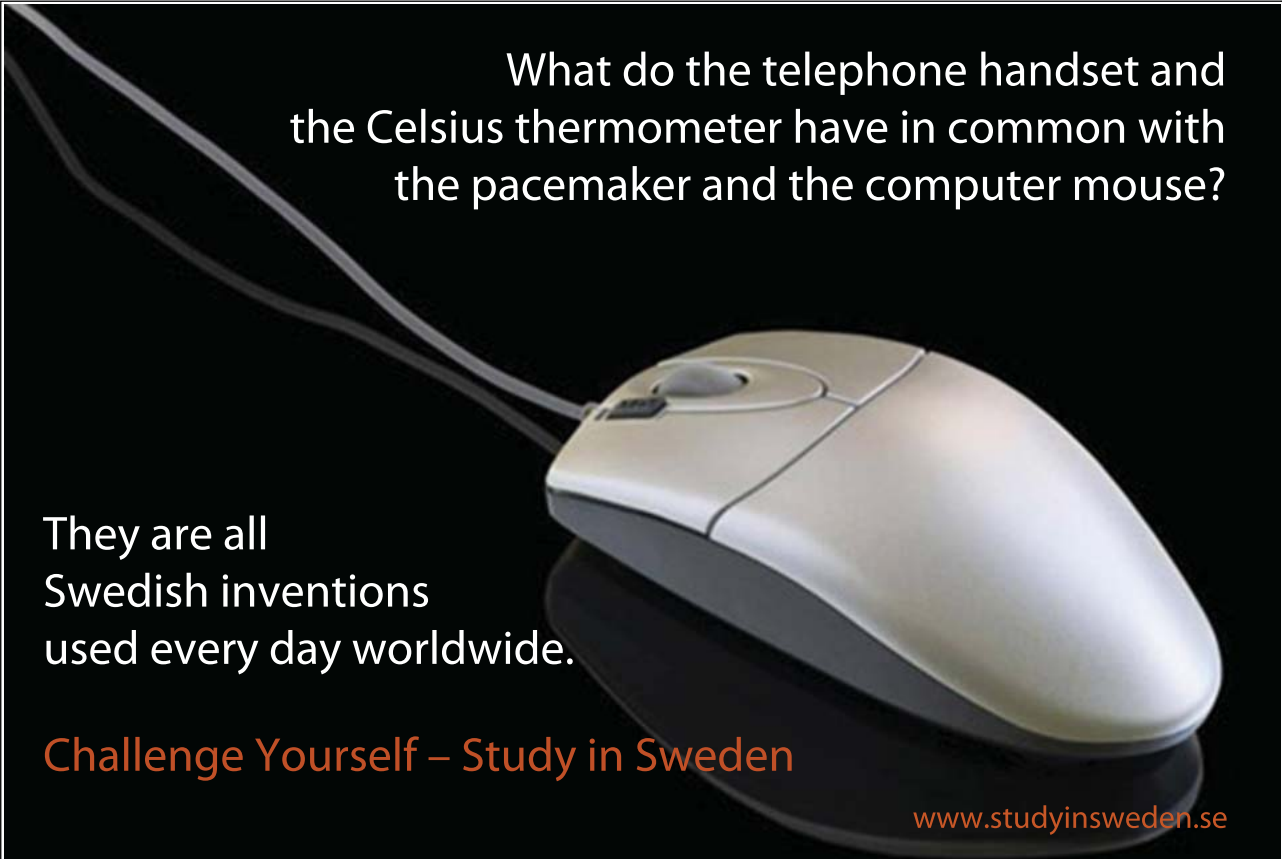

What do the telephone handset and the Celsius thermometer have in common with the pacemaker and the computer mouse?

They are all Swedish inventions used every day worldwide.

Challenge Yourself – Study in Sweden

www.studyinsweden.se

The process of deformation in the theory of elastoplasticity can be divided on **two stages** – on the first stage the elastic strains are occurring in material, on the second stage the strains will be plastic ones.

Here the question arises about the border between these stages. When the stress-strain state is uni-axial (as the shown on the Fig. 15.1), then **the condition of plasticity (yield condition)** is clear – $\sigma \geq \sigma^p$. When the state is biaxial or triaxial, then **the special condition (criterion)** should be used.

Let us restrict the next analysis to isotropic materials. Then appearance of the plastic strains are assumed as fully determined by the acting in material on the first elastic stage elastic stresses. **The condition of plasticity** is usually formulated as follows

$$f(\sigma_1, \sigma_2, \sigma_3) = 0, \quad (15.1)$$

where σ_k are **the principal stresses**.

Note 15.2. The condition (criterion) of plasticity (15.1) can be written using different invariants of the stress tensor.

The condition (15.1) **takes the simplest form for the uniaxial tension** $\sigma_1 = \sigma^p$.

Let us emphasize the important property of plastic deformation process:

The level of plastic property manifestation depends essentially on the type of deformation.

For example, when a circular cylindrical tubes being undergone the torsion in condition of pure torsion, then dependence of the tangent stress and the characterizing the shear angle strain tensor component is quite identical with the shown on Fig.15.1. Then the condition of plasticity is written here as follows

$$|\tau_{\max}| = \frac{1}{2} |\sigma_1 - \sigma_2| = \tau^p,$$

where τ^p is the yield stress for the shear.

On the other hand, a plenty of materials show the pure elastic behaviour under hydrostatic compression up to very high level of compression.

This observation is the basic point in next assumption in constructing the theory of elastoplasticity:

the condition of plasticity depend on the deviator of stress tensor; because the first invariant for deviator is zero by definition, then the second and third invariants can be used in the condition

$$f(I_2^{dev}, I_3^{dev}) = 0, \quad (15.2)$$

Note 15.3. Any strain and stress tensor can be represented as the sum of two tensors – spherical tensor and deviator tensor. The first tensor characterizes the volume strain and stress state; the second tensor characterizes the form change. For isotropic materials, the constitutive equations sometimes are written as two independent groups – for the volume change and for the form change.

Two conditions (criteria) of plasticity are most known – **the Tresca criterion and the Huber-Mises criterion.**

The Tresca criterion states:

the maximal tangent stresses of the deviator of stresses must take the one and the same value, when the plastic state is reached.

In terms of the principal stresses the criterion is as follows

$$2|\tau_1| = |\sigma_1 - \sigma_2| = \sigma^p, \quad 2|\tau_2| = |\sigma_2 - \sigma_3| = \sigma^p, \quad 2|\tau_3| = |\sigma_1 - \sigma_3| = \sigma^p. \quad (15.3)$$

In the case $\sigma_1 \geq \sigma_2 \geq \sigma_3$ formula (15.3) becomes simpler

$$2|\tau_{\max}| = |\sigma_1 - \sigma_3| = \sigma^p. \quad (15.4)$$

The Huber-Mises criterion states:

the second invariant of the deviator of stresses I_2^{dev} must take some constant value, when the plastic state is reached.

The criterion can be treated as some particular representation of criterion (15.2). In terms of **the intensity of stresses** $\sigma^i = 3I_2^{dev}$ the criterion is as follows

$$\sigma^i = 3I_2^{dev} = \sigma^p, \quad (15.5)$$

$$\text{or } (\sigma_{xx} - \sigma_{yy})^2 + (\sigma_{yy} - \sigma_{zz})^2 + (\sigma_{xx} - \sigma_{zz})^2 + 6\left[(\tau_{xy})^2 + (\tau_{yz})^2 + (\tau_{zx})^2\right] = (2\sigma^p)^2.$$

Note 15.4. These criteria can be compared for the case of pure shear. The Tresca criterion gives $|\tau_{\max}| = 0.5\sigma^p$, whereas the Huber-Mises criterion – $|\tau_{\max}| = (1/\sqrt{3})\sigma^p \approx 0.577\sigma^p$. The experiments show the range $(0.56 \div 0.60)\sigma^p$.

It is assumed that both criteria are equitable:

in the particular problem that one should be used which simplifies the solution.

Return to the general problem of constructing the theory of elastoplasticity. Three main problems should be solved:

Problem 1. A generalization of the notion of yield stress.

Problem 2. Introduction the notions of loading and unloading for the general case.

Problem 3. Establishing the laws for increasing the plastic strains for arbitrary laws of changing the stresses.

Now two main types of basic models of elastoplastic deformation should be mentioned:

Type 1. The perfect elastoplastic media, which do not take into account the Bauschinger effect and hardening effect.

Type 2. The hardening elastoplastic media.

Definition 15.5. A changing the proportionality limit under compression after preliminary tension beyond the proportionality limit is called **the Bauschinger effect**.

Definition 15.6. An increasing the proportionality limit under tension after preliminary tension beyond the proportionality limit is called **the hardening effect**.

The hard problem in plasticity is the establishment of history of loading. Two kinds of loading are distinguishing in the theory.

Definition 15.7. The loading is called the **simple** one, when all the components of the stress tensor increase proportionally to one parameter. In other cases the loading is called the **combined** one.

Please click the advert



Do you want your Dream Job?

More customers get their dream job by using RedStarResume than any other resume service.

RedStarResume can help you with your job application and CV.

Go to: Redstarresume.com
Use code "BOOKBOON" and save up to \$15

(enter the discount code in the "Discount Code Box")



Example 15.1. Let the thin-wall circular cylindrical tube with external radius r_o and wall thickness h_o is subjected to the uniform axial tension T and torsion M . Assuming the stress state to be plane, the next formulas for the normal σ_{rr} and tangent $\tau_{r\varphi}$ stresses can be written

$$\sigma_{rr} = \left[T / (2\pi r_o h_o) \right], \quad \tau_{r\varphi} = \left[M / \left(2\pi (r_o)^2 h_o \right) \right].$$

When T, M are changed proportionally to some parameter s , then $\sigma_{rr}, \tau_{r\varphi}$ will change also proportionally to the parameter s . **Thus the simple loading takes the place.**

In the general case, the simple loading assumes equalities for all the components of stress tensor

$$\sigma_{ik} = s \sigma_{ik}^o.$$

Then two invariants of the stress state $\sigma^{(sph)}, \sigma^{(int)}$ depend on the parameter s

$$\sigma^{(sph)} = \frac{1}{3} (\sigma_{11} + \sigma_{22} + \sigma_{33}) = s \sigma^{o(sph)}, \quad \sigma^{(int)} = s \sigma^{o(int)},$$

$$\sigma^{o(int)} = \frac{1}{\sqrt{2}} \left[(\sigma_{xx} - \sigma_{yy})^2 + (\sigma_{yy} - \sigma_{zz})^2 + (\sigma_{xx} - \sigma_{zz})^2 + 6 \left((\tau_{xy})^2 + (\tau_{yz})^2 + (\tau_{zx})^2 \right) \right]^{1/2}.$$

Note 15.5. Sometimes the definition of simple loading is formulated relative to the stress deviator only.

Now another classification of models should be discussed. According to this classification, two kinds of models (theories) are distinguished:

Kind 1. Deformation plasticity theories. Kind 2. Theories of plastic flow.

In the kind 1 theories, the constitutive equations link the stresses and strains like the classical theory of elasticity. These equations link the functions.

In the kind 2 theories, the infinitesimal increments of plastic strains and stresses are linked in constitutive equations. In this case, the equations link the differentials of functions.

Consider **the theory of small elastoplastic deformations**. It is based on three hypotheses.

Hypothesis 1. The volume deformation is assumed to be linearly elastic by the Hooke law

$$\sigma^{(sph)} = 3K \varepsilon^{(sph)}, \tag{15.6}$$

where K is the bulk elastic modulus.

Hypothesis 2. Stress and strain deviators coincide accurate within the arbitrary multiplier

$$\sigma_{ik}^{(dev)} = S \varepsilon_{ik}^{(dev)},$$

$$\text{or } \sigma_{mm} - \sigma^{(sph)} = S \left(\varepsilon_{mm} - \varepsilon^{(sph)} \right), \quad \sigma_{ik} = S \varepsilon_{ik} \quad (i \neq k). \quad (15.7)$$

Basing on (19.7) the quantities $\sigma^{(int)}, \varepsilon^{(int)}$ can be evaluated and linked $\sigma^{(int)} = (3/2) S \varepsilon^{(int)}$. Then $S = (2\sigma^{(int)} / 3\varepsilon^{(int)})$.

Hypothesis 3. Relationship $\sigma^{(int)} = \Phi(\varepsilon^{(int)})$ does not depend on the form of stress state.

Consider now the basic statements of **the theories of plastic flow**. Firstly introduce the notion of intensity of increments of plastic strains

$$d\varepsilon^{p(int)} = \frac{\sqrt{2}}{3} \left[\left(d\varepsilon_{xx}^p - d\varepsilon_{yy}^p \right)^2 + \left(d\varepsilon_{yy}^p - d\varepsilon_{zz}^p \right)^2 + \left(d\varepsilon_{zz}^p - d\varepsilon_{xx}^p \right)^2 + 3 \left((\varepsilon_{xy}^p)^2 + (\varepsilon_{yz}^p)^2 + (\varepsilon_{zx}^p)^2 \right) \right]^{1/2}.$$

Note 15.6. Intensity of increments of plastic strains does not equal to the increment of intensity of plastic strains.

Introduce also the deviator of increments of plastic strains as the tensor with components $\varepsilon_{mm} - \varepsilon^{(sph)}$ and $\varepsilon_{ik} \quad (i \neq k)$.

Write now four basic hypotheses of the theory of plastic flow for isotropic materials.

Hypothesis 1. The volume deformation is assumed to be linearly elastic by the Hooke law

$$\varepsilon^{(sph)} = (1/3K) \sigma^{(sph)} \text{ or } d\varepsilon^{(sph)} = (1/3K) d\sigma^{(sph)}.$$

Note 15.7. It follows from the Hypothesis 1 that $d\varepsilon^{(sph)(pl)} = 0$, what can be meant that the material in plastic state is incompressible.

Hypothesis 2. The increment of each separate strain component is the sum of increments of corresponding elastic and plastic strains $d\varepsilon_{ik} = d\varepsilon_{ik}^{(el)} + d\varepsilon_{ik}^{(pl)}$.

Hypothesis 3. Components of deviators of increments of plastic strains and stresses coincide accurate within the arbitrary multiplier

$$d\varepsilon_{mm}^{(pl)} = dS \left(\sigma_{mm} - \sigma^{(sph)} \right), \quad d\varepsilon_{ik}^{(pl)} = dS \sigma_{ik} \quad (i \neq k).$$

Similarly to the procedure shown after relationships (15.7) the formula $dS = (3d\varepsilon^{(int)(pl)} / 2\sigma^{(int)})$ can be obtained.

Hypothesis 4. The link between the hardening parameter and stress intensity does not depend on the type of stress state. Let us discuss the hardening parameter. Usually it is chosen in the form of Odqvist parameter

$$\eta = \int d\varepsilon^{(int)(pl)}. \quad (15.8)$$

Note 15.8. To separate processes of loading and unloading in the general case, the hardening condition is usually introduced through the function $\Phi(\eta)$, depending on the hardening parameter η

$$F(I_2^{(dev)}, I_3^{(dev)}) = \Phi(\eta) \text{ or } \sigma^{(int)} = \Phi(\eta). \quad (15.9)$$

In the theory of plastic flow taking into account (15.8) the condition (15.9) is changed to

$$\sigma^{(int)} = \Phi(d\varepsilon^{(int)(pl)}). \quad (15.10)$$

Note 15.9. For the simplest case of uniaxial tension $\eta = \varepsilon^{(pl)}$ and $\sigma = \Phi(\varepsilon^{(pl)})$.

When equality (15.10) being met, then the condition of loading process at the point is $d\sigma^{(int)} > 0$ and the condition of unloading is $d\sigma^{(int)} < 0$.

Please click the advert

Brain power

By 2020, wind could provide one-tenth of our planet's electricity needs. Already today, SKF's innovative know-how is crucial to running a large proportion of the world's wind turbines.

Up to 25 % of the generating costs relate to maintenance. These can be reduced dramatically thanks to our systems for on-line condition monitoring and automatic lubrication. We help make it more economical to create cleaner, cheaper energy out of thin air.

By sharing our experience, expertise, and creativity, industries can boost performance beyond expectations. Therefore we need the best employees who can meet this challenge!

The Power of Knowledge Engineering

Plug into The Power of Knowledge Engineering.
Visit us at www.skf.com/knowledge

SKF

Download free ebooks at bookboon.com

The last consideration is associated with the constitutive equations for unloading. Let intensity of stresses $\sigma^{(int)}$ decreases from the value denoted by index (**) to the value denoted by index (*). Then the Hooke law is assumed to be valid for the unloading process and constitutive equations have the form

$$\begin{aligned}\sigma^{(sph)*} &= 3K\varepsilon^{(sph)*} + \left(\sigma^{(sph)**} - 3K\varepsilon^{(sph)**}\right), \\ \sigma_{xx}^* - \sigma^{(sph)*} &= 2G\left(\varepsilon_{xx}^* - \varepsilon^{(sph)*}\right) + \left[\left(\sigma_{xx}^{**} - \sigma^{(sph)**}\right) - 2G\left(\varepsilon_{xx}^{**} - \varepsilon^{(sph)**}\right)\right], \\ \sigma_{yy}^* - \sigma^{(sph)*} &= 2G\left(\varepsilon_{yy}^* - \varepsilon^{(sph)*}\right) + \left[\left(\sigma_{yy}^{**} - \sigma^{(sph)**}\right) - 2G\left(\varepsilon_{yy}^{**} - \varepsilon^{(sph)**}\right)\right], \\ \sigma_{zz}^* - \sigma^{(sph)*} &= 2G\left(\varepsilon_{zz}^* - \varepsilon^{(sph)*}\right) + \left[\left(\sigma_{zz}^{**} - \sigma^{(sph)**}\right) - 2G\left(\varepsilon_{zz}^{**} - \varepsilon^{(sph)**}\right)\right], \\ \sigma_{xy}^* &= 2G\varepsilon_{xy}^* + \left(\sigma_{xy}^{**} - 2G\varepsilon_{xy}^{**}\right), \quad \sigma_{yz}^* = 2G\varepsilon_{yz}^* + \left(\sigma_{yz}^{**} - 2G\varepsilon_{yz}^{**}\right), \quad \sigma_{xz}^* = 2G\varepsilon_{xz}^* + \left(\sigma_{xz}^{**} - 2G\varepsilon_{xz}^{**}\right).\end{aligned}\tag{15.11}$$

Thus, the unloading process is fully defined by constitutive equations (15.11). Of course, additionally should be met other equations from the basic system of the theory of elastoplasticity.

Let us write this full system of equations for the theory of small elastoplastic deformations. They include four groups of equations (the first three coincide with the corresponding groups of the theory of elasticity).

Three equations of motion

$$\sigma_{xx,x} + \sigma_{yx,y} + \sigma_{zx,z} + F_x = \rho\ddot{u}_x,$$

$$\sigma_{xy,x} + \sigma_{yy,y} + \sigma_{zy,z} + F_y = \rho\ddot{u}_y,\tag{15.12}$$

$$\sigma_{xz,x} + \sigma_{yz,y} + \sigma_{zz,z} + F_z = \rho\ddot{u}_z.$$

Six linear Cauchy relationships

$$\varepsilon_{xx} = u_{x,x}, \quad \varepsilon_{yy} = u_{y,y}, \quad \varepsilon_{zz} = u_{z,z},\tag{15.13}$$

$$\varepsilon_{xy} = \frac{1}{2}(u_{x,y} + u_{y,x}), \quad \varepsilon_{yz} = \frac{1}{2}(u_{z,y} + u_{y,z}), \quad \varepsilon_{xz} = \frac{1}{2}(u_{x,z} + u_{z,x}).$$

Six equations of compatibility

$$\varepsilon_{xx,yy} + \varepsilon_{yy,xx} - 2\varepsilon_{xy,xy} = 0, \quad \varepsilon_{zz,yy} + \varepsilon_{yy,zz} - 2\varepsilon_{zy,zy} = 0, \quad \varepsilon_{xx,zz} + \varepsilon_{zz,xx} - 2\varepsilon_{xz,xz} = 0,\tag{15.14}$$

$$\varepsilon_{xx,yz} + \varepsilon_{yz,xx} - \varepsilon_{xz,xy} - \varepsilon_{xy,xz} = 0, \quad \varepsilon_{yy,xz} + \varepsilon_{xz,yy} - \varepsilon_{yz,xy} - \varepsilon_{xy,yz} = 0, \quad \varepsilon_{zz,yx} + \varepsilon_{yx,zz} - \varepsilon_{yz,zx} - \varepsilon_{xz,yz} = 0.$$

Six constitutive equations**for loading**

$$\begin{aligned}
\sigma_{xx} &= \left(3K - \frac{2\Phi(\varepsilon^{(int)})}{3\varepsilon^{(int)}} \right) \varepsilon^{(sph)} + \frac{2\Phi(\varepsilon^{(int)})}{3\varepsilon^{(int)}} \varepsilon_{xx}, \\
\sigma_{xx} &= \left(3K - \frac{2\Phi(\varepsilon^{(int)})}{3\varepsilon^{(int)}} \right) \varepsilon^{(sph)} + \frac{2\Phi(\varepsilon^{(int)})}{3\varepsilon^{(int)}} \varepsilon_{xx}, \\
\sigma_{xx} &= \left(3K - \frac{2\Phi(\varepsilon^{(int)})}{3\varepsilon^{(int)}} \right) \varepsilon^{(sph)} + \frac{2\Phi(\varepsilon^{(int)})}{3\varepsilon^{(int)}} \varepsilon_{xx}, \\
\sigma_{xy} &= \frac{2\Phi(\varepsilon^{(int)})}{3\varepsilon^{(int)}} \varepsilon_{xy}, \sigma_{xy} = \frac{2\Phi(\varepsilon^{(int)})}{3\varepsilon^{(int)}} \varepsilon_{xy}, \sigma_{xy} = \frac{2\Phi(\varepsilon^{(int)})}{3\varepsilon^{(int)}} \varepsilon_{xy},
\end{aligned} \tag{15.15}$$

for unloading

$$\begin{aligned}
\sigma^{(sph)*} &= 3K\varepsilon^{(sph)*} + \left(\sigma^{(sph)**} - 3K\varepsilon^{(sph)**} \right), \\
\sigma_{xx}^* - \sigma^{(sph)*} &= 2G(\varepsilon_{xx}^* - \varepsilon^{(sph)*}) + \left[\left(\sigma_{xx}^{**} - \sigma^{(sph)**} \right) - 2G(\varepsilon_{xx}^{**} - \varepsilon^{(sph)**}) \right], \\
\sigma_{yy}^* - \sigma^{(sph)*} &= 2G(\varepsilon_{yy}^* - \varepsilon^{(sph)*}) + \left[\left(\sigma_{yy}^{**} - \sigma^{(sph)**} \right) - 2G(\varepsilon_{yy}^{**} - \varepsilon^{(sph)**}) \right], \\
\sigma_{zz}^* - \sigma^{(sph)*} &= 2G(\varepsilon_{zz}^* - \varepsilon^{(sph)*}) + \left[\left(\sigma_{zz}^{**} - \sigma^{(sph)**} \right) - 2G(\varepsilon_{zz}^{**} - \varepsilon^{(sph)**}) \right], \\
\sigma_{xy}^* &= 2G\varepsilon_{xy}^* + \left(\sigma_{xy}^{**} - 2G\varepsilon_{xy}^{**} \right), \sigma_{yz}^* = 2G\varepsilon_{yz}^* + \left(\sigma_{yz}^{**} - 2G\varepsilon_{yz}^{**} \right), \sigma_{xz}^* = 2G\varepsilon_{xz}^* + \left(\sigma_{xz}^{**} - 2G\varepsilon_{xz}^{**} \right).
\end{aligned} \tag{15.16}$$

So, the shown above basic system of equations permits to solve many dynamic problems for elastoplastic materials. But the problem of waves in elastoplastic materials seems to be very distinguishing as compared with the elastic materials. To begin with, the harmonic waves in elastic materials are considered as the simplest kind of waves permitting the analytical approach. In contrast to this case, an analysis of harmonic waves in elastoplastic materials becomes markedly more complicate owing to necessity to describe unloading on each oscillation.

**Basically, unloading is the key word in elastoplasticity and
can not be ignored in any problem including the wave problems.**

Fortunately, the problem of shock wave propagation in elastoplastic materials is not so complicate and can be explained within the framework of one lecture. Next chapter-lecture will be devoted to just such waves.

Comments

The history of loading (the sequence of loading) does not influence on the final distribution of strains in an elastic material.

In an elastoplastic material, the history mentioned influences very significantly on the final distribution of strains. For different sequences of loading the strains at one and the same points can be essentially different.

Thus the fundamental distinction between the nonlinearly elastic and elastoplastic materials consists in that when a structure member (rod, beam, plate and so on) being loaded, then the distinction between materials is absent (for example, the stress state in the plate will be inhomogeneous – in some parts of the plate the stresses do not exceed the yield limit and in other ones – exceed).

In the case, when the structure member being unloaded, then it made of elastic material returns into the initial undeformed state, whereas in the same structure member made of elastoplastic material all the parts, in which the yield limit was exceeded (so called plasticity zones) will be in the state of unremoveable deformed state.

Consider here six assumptions, which should be made, when the simplest model of plastic material is constructing.

Assumption 1. The plastic deformation has a perfect character (hardening is absent).

Assumption 2. The deformation process has an isotropic character (the initial and deformational anisotropies are absent).

Assumption 3. The isotropy is normal (the behaviour of material is identical for loadings with different signs).

Assumption 4. The plastic deformation does not depend on action of uniform compression.

Assumption 5. The elastic deformations in the material are absent (that is, the model assumes the rigid-plastic deformation).

Assumption 6. The material is homogeneous relative to all the properties.

So, the material is assumed to be the homogeneous perfect normally isotropic incompressible rigid-plastic one. In such a material, the mechanical work of forces dissipates fully into heat. Therefore, in this case the basic principle (the maximum principle) is formulated:

the rate of dissipation of mechanical energy in the unit volume under plastic deformation is maximal for the real stress state compared with all the stress states admissible by the plasticity condition.

It should be noted once again that the presence of dissipation distinguishes the elastoplastic models from elastic ones.

Finally, it should be noted that Timoshenko in his famous book *History of Strength of Materials* (McGraw-Hill, New York, 1953) has been stated that the Mises condition of plasticity has been firstly formulated by Maxwell in the letter to Thomson.

Further reading

1. Alexandrov, AV & Potapov, VD 1990, *Fundamentals of the Theory of Elasticity and Plasticity*. Vysshaya shkola, Moscow. (In Russian)
2. Freudenthal, AM & Geiringer, H 1958, *The Mathematical Theories of the Inelastic Continuum*. Flügge Handbuchder Physik, Springer, Berlin.
3. Hill, R 1950, *The Mathematical Theory of Plasticity*. Oxford University Press, London.
4. Ilyushin, AA 1948. *Plasticity*, GITTL, Moscow. (In Russian). Iliouchine, AA 1956, *Plasticite (Deformations elastico-plastiques)*. Eyrolle, Paris. (In French)
5. Kachanov, LM 1956, *Fundamentals of the Theory of Plasticity*. GITTL, Moscow. (In Russian)
6. Perzyna, P 1966, *Fundamental Problems in Viscoplasticity*, Advances in Applied Mechanics, vol. 9, Academic Press, New York.
7. Prager, W & Hodge, PG 1951, *Theory of Perfectly Plastic Solids*. John Wiley, New York.
8. Prager, W 1955, *Probleme der Plastizitätstheorie*. Birkhäuser, Basel. (In German)
9. Prager, W 1961, *Einführung in die Kontinuumsmechanik*. Birkhäuser Verlag, Basel und Stuttgart. (In German)
10. Sokolovsky, VV 1950, *Theory of Plasticity*. GITTL, Moscow. (In Russian).

Questions

- 15.1. The energy of elastic deformation is changed proportionally to the values of elastic strains, it is not accumulated and dissipated. How can be commented in this connection energy of plastic deformation?
- 15.2. It is well-known in the nonlinear elasticity that two kinds of nonlinearity can be occurred in materials – heavy and soft. For example, Fig.15.1 shows the soft nonlinearity. Comment a possibility of the heavy variant for the plastic deformation.
- 15.3. Construct the yield surface for the simplest Tresca model, taking into account that the surface must be in the space of principal stresses and have the shape of hexagonal prism. Comment the statement that any direction of plastic flow corresponds to corresponding side of the prism.
- 15.4. Construct the yield surface for the Mises model, taking into account that the surface must be in the space of principal stresses and have the shape of the circular cylinder.
- 15.5. Initially Odqvist has been proposed the hardening parameter in the form $d\eta = \sqrt{\left(\frac{2}{3}\right) \sum_{i,k} d\varepsilon_{ik}^{(pl)} d\varepsilon_{ik}^{(pl)}}$. Compare with (15.8) and comment.
- 15.6. Show link between Lüders lines and the perfect plastic flow, which is sometimes meant as the result of small sliding over certain sliding surfaces.

16 Elastoplastic shock waves

Classical models of elastoplastic deformation. Shock waves in the rod. Basic system of equations. Basic properties of shock waves.

The topic of this chapter-lecture will be waves in materials manifesting the plastic property when being deformed. Two books (Davies, RM 1956; Rakhmatullin, KhA & Demyanov, YuA 1961) and one pioneer journal publication (Wood, DS 1952) can be meant as the basic in next description of waves.

Remember first the diagram from the prior chapter-lecture. It shows the dependence “stress – strain” for standard tests on sample tension.

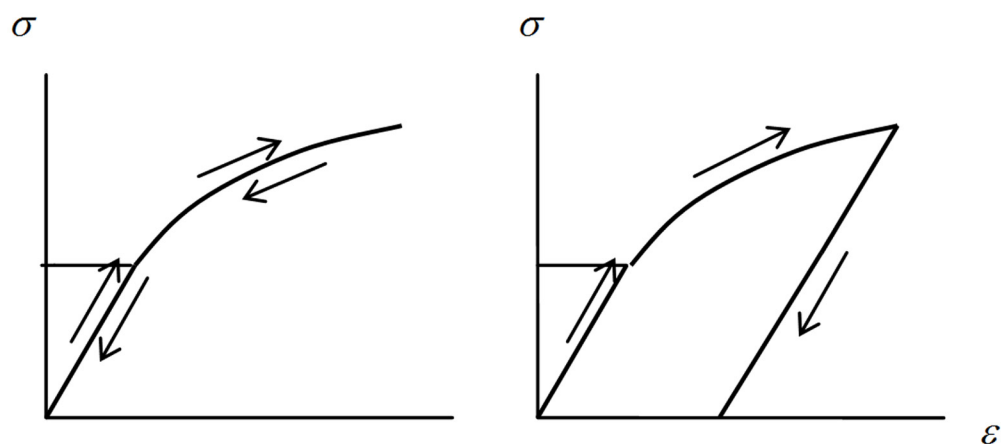

Fig.16.1. The dependence $\sigma \sim \varepsilon$ for standard tests on sample tension.

The plots show identically the linear and nonlinear parts of the loading diagram; the left hand plot corresponds to the loading-unloading process for the nonlinearly elastic materials, the right hand plot – for the elastoplastic materials.

When the loading only procedure is assumed and strains are assumed to be corresponding to values beyond the proportionality limit, then the fundamental distinction between nonlinearly elastic and elastoplastic materials is vanishing and strains only can be assumed not small with the values corresponding the finite strains.

This statement was one of the main starting positions in the pioneer analysis of waves in elastoplastic materials. Usually a few of famous scientists are referred: von Karman, Taylor, Rakhmatullin - to the pioneers in this area. The book (Davies, RM 1956) comments the history and priorities of pioneer analysis of waves in elastoplastic materials.

In this chapter, the fundamental feature of these studies is especially emphasized – **the shock waves in the rod are considered.**

This means that the unloading is not considered, because this process does not appear in such a statement.

Note 16.1. This reveals a feature of the plasticity theories compared with the elasticity theories – an analysis of harmonic waves becomes essentially more complicate for the elastoplastic materials. Therefore the chapter will follow the classics and all the peculiar properties of waves will be considered here on examples of shock waves.

Note 16.2. As it is noted in (Davies, RM 1956), these results can not be considered as the special development of the theory of plastic waves. They can be meant rather as the pioneer analysis in the theory of shock waves in elastoplastic materials.

The next part of the chapter is devoted to the concise statement of Taylor, von Karman, and Rakh matullin results.

Taylor approach

The rod is thin and very long (semi-infinite in the model); the left side of rod is loaded in the way that the longitudinal velocity is increased in a moment up to some finite value v_0 .

The Eulerian coordinate system is used; x is the spatial coordinate of the semi-infinite rod measured from the rod end to the right direction; the stress is measured relative to the initial rod cross-section; v is the longitudinal velocity of the rod particle, referred to the non-deformed rod state; the uniaxial stress-strain state (like to the shown on Fig. 16.1) is described by the relationship $\sigma = \sigma(\varepsilon)$; ρ_0 is the density in the non-deformed rod state.

Trust and responsibility

NNE and Pharmaplan have joined forces to create NNE Pharmaplan, the world's leading engineering and consultancy company focused entirely on the pharma and biotech industries.

Inés Aréizaga Esteva (Spain), 25 years old
Education: Chemical Engineer

– You have to be proactive and open-minded as a newcomer and make it clear to your colleagues what you are able to cope. The pharmaceutical field is new to me. But busy as they are, most of my colleagues find the time to teach me, and they also trust me. Even though it was a bit hard at first, I can feel over time that I am beginning to be taken seriously and that my contribution is appreciated.



NNE Pharmaplan is the world's leading engineering and consultancy company focused entirely on the pharma and biotech industries. We employ more than 1500 people worldwide and offer global reach and local knowledge along with our all-encompassing list of services.
nnepharmaplan.com

nne pharmaplan®

Please click the advert

Then the motion and continuity equations are as follows

$$\frac{Dv}{Dt} \equiv \frac{\partial v}{\partial t} + v \frac{\partial v}{\partial x} = \frac{1+\varepsilon}{\rho_o} \frac{\partial \sigma}{\partial x} \equiv \frac{1+\varepsilon}{\rho_o} \frac{\partial \sigma}{\partial \varepsilon} \frac{\partial \varepsilon}{\partial x}, \quad (16.1)$$

$$\frac{D\varepsilon}{Dt} \equiv \frac{\partial \varepsilon}{\partial t} + v \frac{\partial \varepsilon}{\partial x} = (1+\varepsilon) \frac{\partial v}{\partial x}. \quad (16.2)$$

Taylor has been observed the identity of these equations with equations of the one-dimensional system of hydrodynamical equations, considered by Earnshaw and Riemann about hundred years ago

$$\frac{Dv}{Dt} + \frac{\varphi(\rho)}{\rho} = 0, \quad \frac{D\rho}{Dt} + \rho \frac{\partial v}{\partial x} = 0.$$

Then the exact solution of system (16.1),(16.2) can be written using results of Earnshaw and Riemann. This solution has the form of the simple wave (the Riemann wave):

the velocity of propagation of the given initially strain or stress relative to the no deformed part of rod c is equal to the sum of two quantities

$$c = c_T + v, \quad c_T = (1+\varepsilon) \sqrt{\frac{1}{\rho_o} \frac{d\sigma}{d\varepsilon}}, \quad v = -\int_0^\varepsilon \sqrt{\frac{1}{\rho_o} \frac{d\sigma}{d\varepsilon}} d\varepsilon. \quad (16.3)$$

Here, the quantity c_T is the obtained by Taylor variable velocity in Eulerian coordinate system.

In the case, when the values of stress and strain do not exceed the values corresponding to the proportionality limit (that is, they corresponds to the linearly elastic case), then

$$c_T = c_o = \sqrt{\frac{E}{\rho_o}}, \quad v = -\frac{\sigma}{\rho_o c_o}. \quad (16.4)$$

Note 16.3. Last formulas testify that the small level of strain causes the wave propagating with the classical velocity of elastic waves in the rod (because E is the Young elastic modulus).

In the case, when the values of stress and strain exceed the values corresponding to the proportionality limit (that is, they corresponds to the plastic range of deformation process), then the wave will consist of two parts – elastic and plastic.

The elastic shock wave is propagated with the velocity (16.4); the wave front is characterized by that the stress on the front takes the value corresponding to the proportionality limit $\sigma = \sigma^p$ being zero behind the front. So, the stress and corresponding strain in the part of rod, in which the wave was traveled, are constant and correspond to the shock wave parameters. The rod particle velocity v takes value (16.4) being also zero up to and behind the front.

Two main quantities c_T, v characterizing the plastic wave propagation are in general the functions of stress or strain $c_T = c_T(\varepsilon), v = v(\varepsilon)$. This means that some wave parameters will change in the process of propagation.

Von Karman approach

The rod is thin and very long (semi-infinite in the model); the left side of rod is loaded in the way that the longitudinal displacement velocity is increased in a moment up to some finite value v_0 . Further the shock wave (the wave of strong discontinuity) is propagating.

The Lagrangean coordinate system is used; a is the spatial coordinate of the semi-infinite rod measured from some fixed coordinate origin to the right direction; the stress is measured relative to the initial rod cross section; u is the longitudinal displacement of the rod particle, referred to the deformed rod state; $v = (\partial u / \partial t)$; $\varepsilon = (\partial u / \partial x)$; the uniaxial stress-strain state (like to the shown on the Fig.16.1) is described by the relationship $\sigma = \sigma(\varepsilon)$; ρ_0 is the density in the non-deformed rod state. Then the motion equation is as follows

$$\rho_0 \frac{\partial v}{\partial t} \equiv \rho_0 \frac{\partial^2 u}{\partial t^2} = \frac{\partial \sigma}{\partial a} \equiv \frac{\partial \sigma}{\partial \varepsilon} \frac{\partial \varepsilon}{\partial a} \equiv \frac{\partial \sigma}{\partial \varepsilon} \frac{\partial^2 u}{\partial a^2} \rightarrow \rho_0 \frac{\partial^2 u}{\partial t^2} = \frac{\partial \sigma}{\partial \varepsilon} \frac{\partial^2 u}{\partial a^2} \rightarrow \frac{\partial^2 u}{\partial t^2} = (c_K)^2 \frac{\partial^2 u}{\partial a^2}. \quad (16.5)$$

Here, the quantity $c_K = \sqrt{\frac{1}{\rho_0} \frac{d\sigma}{d\varepsilon}}$ is the obtained by von Karman variable velocity in Lagrangean coordinate system.

Note 16.4. The use of linear relations $\varepsilon = (\partial u / \partial x)$ instead the nonlinear relation $\varepsilon = (\partial u / \partial x) + (\partial u / \partial x)^2$ is adopted in the linear theory of elasticity and commented by many authors.

The formula for velocity of rod particles v can be derived like to the prior case (in Taylor approach) by integration

$$v = -\int_0^\sigma c_K d\varepsilon = -\int_0^\varepsilon \sqrt{\frac{1}{\rho_0} \frac{d\sigma}{d\varepsilon}} d\varepsilon. \quad (16.6)$$

Now von Karman equations (16.5),(16.6) can be compared with Taylor equations (16.1)-(16.3). It is accepted that they are identical and the distinctions in formulas for velocities is caused by using different coordinate system only.

Experiments testified that when the shock being produced with the constant velocity, then the plastic wave is propagated along the rod and the constant maximal stress is reached on the wave front and in the part of rod, where the wave was travelled.

Wood approach

This approach continues the prior one in most positions. The waves are still unidirectional longitudinal with the plane front. Some more attention is drawn to the stress-strain relation. The special experiment on simple tension-compression is carried out. But also some additional assumptions are offered:

Assumption 1. The plane problem statement is used for description of stresses σ_x, σ_y and strains $\varepsilon_x, \varepsilon_y$ in the circular rod and σ_y, ε_y do not depend on the direction in the rod cross-section.

Assumption 2. Strains are separating into elastic and plastic parts $\varepsilon_x = \varepsilon_x^e + \varepsilon_x^p$, $\varepsilon_y = \varepsilon_y^e + \varepsilon_y^p$.

Assumption 3. For elastic state the linear Hooke law is assumed.

Assumption 4. The plastic properties are manifesting in the shear strain only $\varepsilon_x^p + 2\varepsilon_y^p = 0$.

Assumption 5. The plastic state is assumed to be independent of strain rate and of the form $\sigma_x - \sigma_y = \sigma(\varepsilon_x^p)$, where the function σ will be further determined from the experiment on simple tension-compression as $\sigma = \sigma(\varepsilon^p)$.

Note 16.5. The assumption 1 refines the elementary theory of longitudinal wave propagation in rods in the sense that the assumption takes into account the motion of material in the transverse direction.

Note 16.6. The assumption 5 corresponds both the Mises yield condition, and the maximum shear stress yield criterion.

The constitutive equations are assumed as follows:

$$\text{for the elastic state } \sigma_x = \frac{(1-\nu)E}{(1+\nu)(1-2\nu)} \varepsilon_x^e, \quad (16.7)$$

$$\text{for the plastic state } \sigma_x = \frac{1-\nu}{1-2\nu} \sigma(\varepsilon_x^p) + \frac{E}{2(1-2\nu)} \varepsilon_x^p. \quad (16.8)$$

Please click the advert

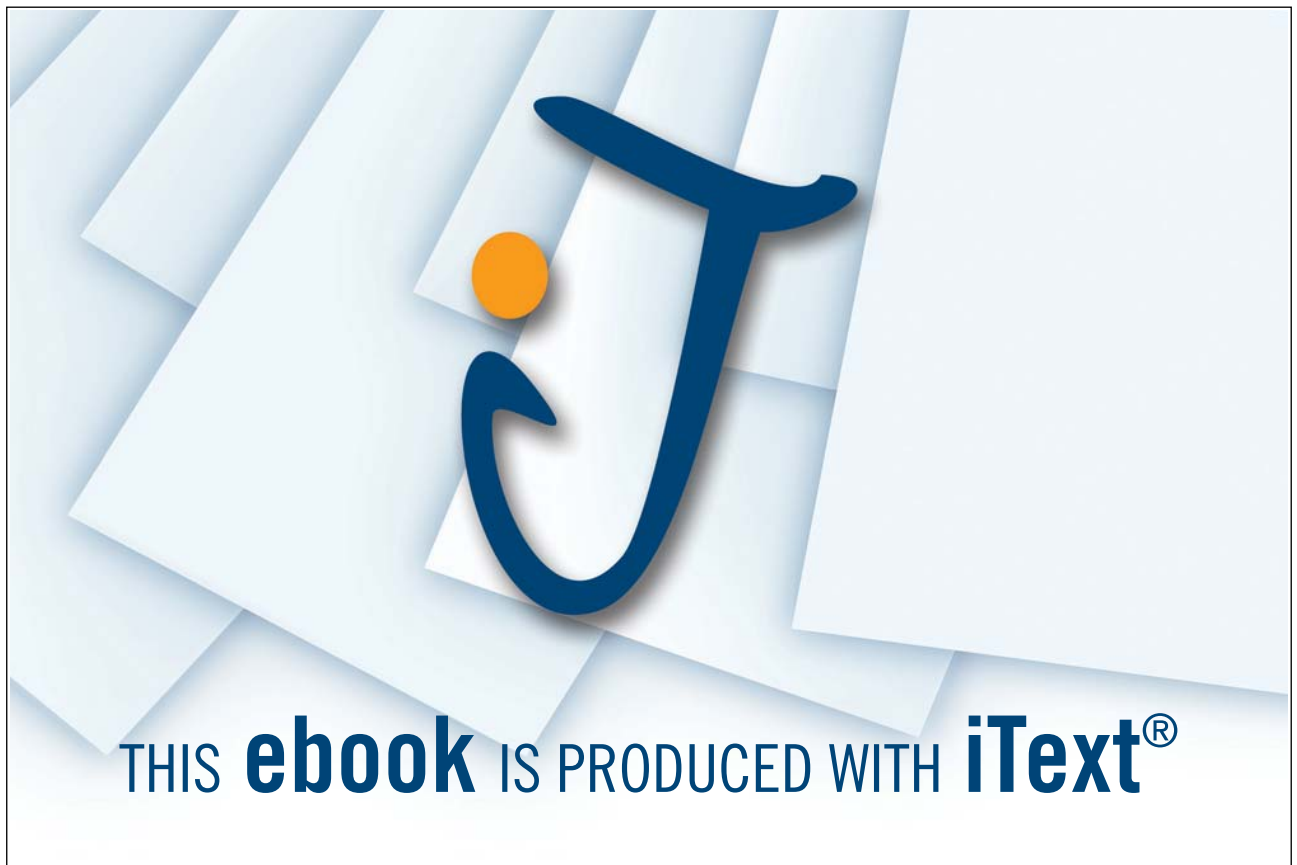

Four very important figures from the Wood's experiments should be shown here.

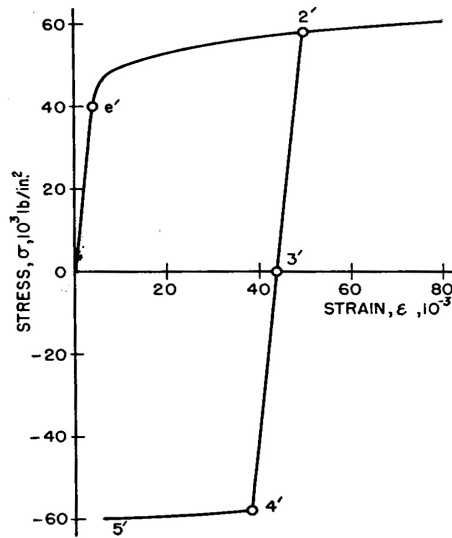

Fig.16.1. The stress-strain relation $\sigma \sim \epsilon$ for 248-T Aluminum alloy in the simple tension-compression test

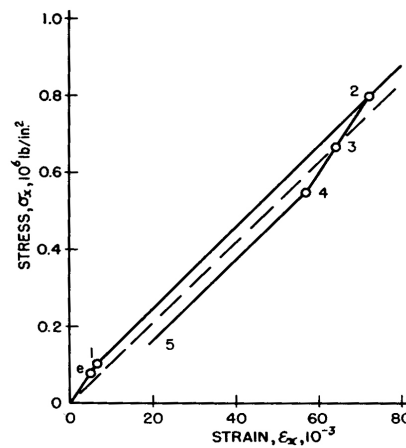

Fig.16.2. The reevaluated by the use of (16.7), (16.8) curves from the test above for another relation $\sigma_x \sim \epsilon_x$.

Note 16.7. It should be noted that points $O', e', 2'$ in Fig.16.1 correspond to points $O, e, 2$ in Fig.16.2.

Note 16.8. Let us draw the attention to the fact that the curves obtained in the static test will be further used for analysis of dynamic behaviour of material.

Next important result is the obtained values for the wave velocity:

$$\text{in the elastic state } (0,1) \quad c^{el} = 2.46 \cdot 10^5 \text{ ips} = 2.46 \cdot 10^5 \cdot 2.54 \text{ m/s} = 6.248 \text{ km/s};$$

$$\text{in the plastic state } (1,2) \quad c^{pl} = 2.01 \cdot 10^5 \text{ ips} = 2.01 \cdot 10^5 \cdot 2.54 \text{ m/s} = 5.105 \text{ km/s}.$$

Thus, the plastic wave is about 18 percent slower than the elastic wave.

Next two figures show some results of Wood's tests on propagation of shock waves in the elastoplastic plate of finite thickness l . A pressure pulse of short duration is applied to the plate surface. The pulse shape consists of five equal by duration steps as is shown on the Fig. 16.3. The total duration of pulse is equal to quarter of time, which is needed for propagation over the all thickness l by elastic waves. It is assumed also that the maximal value of pulse p_2 exceeds ten times the stress corresponding to the yield limit what means that the lower step only will be associated with the strain elastic range and other steps will exceed the plastic strains.

The main effect is changing the initial pulse shape.

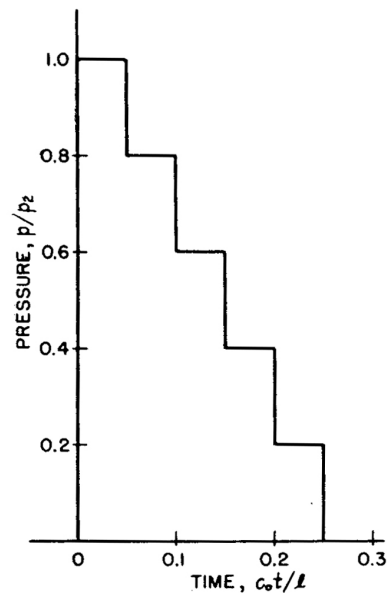

Fig.16.3. The pulse shape

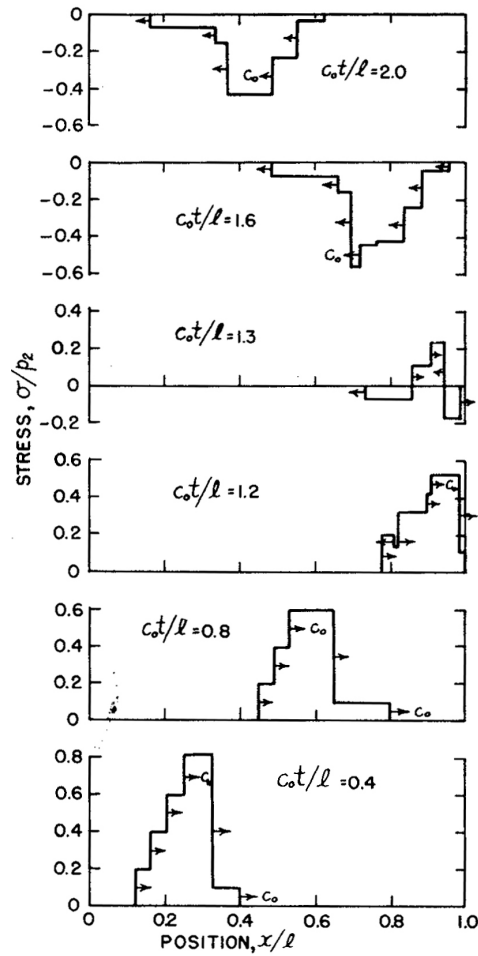

Fig. 16.4. The shape of the pulse for different moments of wave propagation

The second effect – an attenuation of the initial pulse shape – is explained as follows:

The pulse attenuates owing to appearance of the wave of partial unloading of the elastic nature which run down the plastic waves of the primary loading.

Rakhmatullin approach

This approach is in some sense close to the von Karman one. The basic wave equation has the form (16.5), which is repeated below in the form

$$\frac{\partial^2 u}{\partial t^2} = (c_R)^2 \frac{\partial^2 u}{\partial a^2} \left(c_R = \sqrt{\frac{1}{\rho_o} \frac{d\sigma}{d\varepsilon}} \right). \tag{16.9}$$

Note 16.9. The author mentioned especially the rod is circular in the cross-section.

The Lagrangean coordinate system is used; x is the spatial coordinate of the semi-infinite rod measured from some fixed coordinate origin to the right direction; the stress is measured relative to the initial rod cross section; u is the longitudinal displacement of the rod particle, referred to the deformed rod state; $v = (\partial u / \partial t)$; $\varepsilon = (\partial u / \partial x)$; the uniaxial stress-strain relation $\sigma \sim \varepsilon$ (like to the shown on Fig.16.1) is described as $\sigma = \sigma(\varepsilon)$; ρ_0 is the density in the non-deformed rod state.

The relation $\sigma = \sigma(\varepsilon)$ is restricted by some additional assumption:

Assumption 1. The relation $\sigma = \sigma(\varepsilon)$ is identical for all the values of wave propagation time and distance.

Assumption 2. The curve $\sigma = \sigma(\varepsilon)$ is convex one, that is, the derivative $(d\sigma/d\varepsilon)$ is monotonically decreasing function.

Assumption 3. The law $\sigma = \sigma(\varepsilon)$ is determined from experiments for the slow (static) loading of corresponding samples. But it seems for the author that the law can be applied to the fast (dynamic) loading, which is considered in the Rakhmatullin approach. The wave equation is solved by the classical method of characteristics. According to the method equation (16.9) is equivalent to the system of characteristics

$$dx = \pm c_R dt, \tag{16.10}$$

$$dv = \pm c_R d\varepsilon. \tag{16.11}$$

The equation (16.11) can be integrated $v = \pm \int_0^\varepsilon c_R(\varepsilon) d\varepsilon + C_{1,2} \equiv \psi(\varepsilon) + C_{1,2}$, where constants C_1, C_2 will take different values on different characteristics.

Please click the advert

The advertisement features a space-themed background with a galaxy and several spaceships. The main title 'THE MILKROUND SYSTEM' is written in large, stylized, 3D letters. Below it, the text 'LAUNCHING GRADUATE CAREERS' is written in a similar style. There are four main content boxes with icons: a galaxy icon for 'MILKROUND SYSTEM', a planet icon for 'PLANET CAREER ADVICE', a spaceship icon for 'FIRST CONTACT', and a group of spaceships icon for 'Milkround.com: rated the #1 graduate recruitment website...'. The Milkround.com logo is at the bottom right.

THE MILKROUND SYSTEM
 LAUNCHING GRADUATE CAREERS

MILKROUND SYSTEM
 Become a business star with internships, placements, graduate jobs & schemes from leading companies.
www.milkround.com

PLANET CAREER ADVICE
 Inhabited by insights into business careers and orbited by application advice.

FIRST CONTACT
 Get matched to top business employers via intelligent emails landing in your inbox.

Milkround.com: rated the #1 graduate recruitment website in the UK Graduate Careers Survey 2009 of 16,000 university finalists.

Milkround.com

It is necessary for next analysis to specify the boundary and initial conditions:

the boundary condition specifies the stress $\sigma(\varepsilon) = \sigma^o(t)$ or strain $\varepsilon = \varepsilon^o(t)$ for $x = 0$ (at the rod end);

the initial condition reflects the fact that the rod is initially at the rest $v(x,0) = 0$ and in the no deformed state $\varepsilon(x,0) = 0$.

Note 16.10. From the initial condition follows that constants C_1, C_2 are zero.

It is known that the solution of wave equation (16.9) is the function establishing a correspondence among points of toe types: all the points of characteristics and points of intersection of characteristics for different families in planes (x,t) and $(v \equiv u_t, \varepsilon \equiv u_x)$. Let us show below the plane (x,t) and corresponding characteristics.

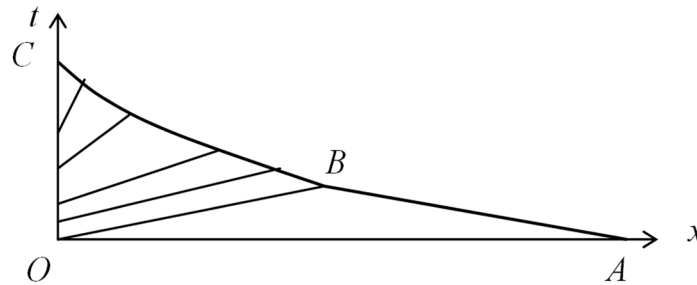

Fig.16.7. The characteristics points and intersection of characteristics points

Here OA corresponds to the rod length, OB and BA are the characteristics of the positive and negative directions, respectively. In the area OAB all the characteristics including OB and BA are rectilinear $d(x \pm c_R^o t) = 0$ ($c_R^o \equiv c_R(0)$). The area OAB corresponds to the plane $(v \equiv u_t, \varepsilon \equiv u_x)$ to the coordinate origin $(v \equiv u_t = 0, \varepsilon \equiv u_x = 0)$. This can be commented as follows:

the rod section x starts to deform with the moment $t = (x/c_R^o)$.

The area OBC corresponds to the solution behind the wave front, for which the integral

$$v = -\psi(\varepsilon) \tag{16.12}$$

is valid.

If the boundary condition $v = \varepsilon(t)$ is chosen, then the functional equation for determination of the strain ε at any point in OBC has the form

$$\varepsilon = \varepsilon^o \left(t - \frac{x}{c_R(\varepsilon)} \right) \tag{16.13}$$

and the velocity is determined by the formula $v = -\psi(\varepsilon)$.

If the boundary condition is given by the formula $\sigma = \sigma^o(t)$ and the stress is assumed to be monotonically increasing during time t^o and then rests constant, then

the rod section x is deformed starting with time $t = (x/c_R^o)$, when the nonlinear loading waves being propagated; the velocity of waves decreases monotonically from the value c_R^o to the value $c_R = c_R(\varepsilon(t^o))$; the strain at the rod section x becomes the value $\varepsilon(t^o)$ after the wave is propagated.

Tending the duration t^o to zero, the limit case of application of instantaneous constant stress $\sigma^o = const$ can be obtained. Because an influence of the rod second end is not manifested, then the solution is given by formulas $c_R(\varepsilon) = (x/t)$, $v = -\psi(\varepsilon)$, that is, the strain and velocity depend on the ratio (x/t) only.

The analysis above is based on assumption $(c_R(\varepsilon))' < 0$, which provides the continuous wave process of loading, because all the next disturbances corresponding to the higher values of strain are propagating with the less velocity and can not run up the prior disturbances.

When $(c_R(\varepsilon))' > 0$, then the next disturbances are propagating faster than prior ones. They add in waves of strong discontinuity. When the applied load being monotonically increased, then the wave of strong discontinuity arises on some distance x^o from the rod end, whereas in the area $x \in [0; x^o]$ the continuous waves are propagating according to formulas (16.12), (16.13).

Note 16.11. According to terminology used in the Taylor approach, the waves determining by formulas (16.12), (16.13) are the Riemann waves or simple waves.

Comments

The case, when the quite high compression is applied at the end of semi-infinite rod and then the compression decreases monotonically with time tending to some constant value, can be realized in the tests, if the explosion or shock by the rigid body at the end are initiated.

Basically, **unloading** is the key word in elastoplasticity and can not be ignored in any problem including the wave problems. Therefore **the unloading waves** should be considered to complete the picture. But owing to essentially more complicated procedures in description of such waves this analysis seems to be beyond the structure of this book.

Nevertheless the definition of unloading wave seems to be in place here. Let the material be deformed linearly elastically up to some value of the strain and further plastically according to the law $\sigma = \sigma(\varepsilon)$. Consider two cases.

Case 1. The maximal value of explosion compression at the bar end does not exceed the proportionality limit. The strain will propagate along the rod with the sound velocity $c_o = \sqrt{(E/\rho_o)}$ (see (16.4)). The rod particle at the distance x from the rod end takes at moment $t = (x/c_o)$ step-wise the maximal strain corresponding to the maximal compression. If compression at the rod end is changed, then the strain at x repeats this change.

Case 2. The maximal value of explosion compression at the bar end exceeds the proportionality limit. The rod particle at the distance x from the rod end will increase continuously starting with the moment $t = (x/c_0)$ by the law $\sigma = \sigma(\varepsilon)$ up to some value, which will be less the maximal strain corresponding to maximal compression at the rod end. Further the strain will decrease depending both on the compression change at the rod end and the law $\sigma = \sigma(\varepsilon)$. So, some moment t exists for given distance x in the plane (x, t) , from which the unloading is starting. In other words, certain curve exists in the plane (x, t) , on the one side of which the loading occurs and on other side of which the unloading occurs.

This curve is called the unloading wave and motion of this curve defines the unloading wave motion.

Further reading

1. Davies, RM 1956, *Stress Waves in Solids*. Surveys in Mechanics. A collection of surveys of the present position of research in some branches of mechanics written in commemoration of the 70th birthday of GI Taylor, Batchelor, GK & Davies, RM (eds), Cambridge University Press, Cambridge.
2. Karman von, T, Bohnenblust, HF & Hyers, DH 1942, 'The Propagation of Plastic Waves in Tension Specimens of Finite Length, Theory and Methods of Integration', *NDRC Report N. A-103 (OSRD N.946)*.
3. Karman von, T & Duwez, P 1950, 'The Propagation of Plastic Deformation in Solids', *J. Appl. Phys.*, vol. 22, pp. 987-994.
4. Lee, EH & Wolf, H 1951, 'Plastic-Wave propagation Effects in High-Speed Testing', *Trans.ASME, J. Appl.Mech.*, vol. 18, no. 4, pp. 379-386.
5. Nowacki WK 1974, *Wave Problems in the Theory of Plasticity*, PWN, Warszawa. (In Polish) (In Russian, 1978).
6. Perzyna, P 1966, *Fundamental Problems in Viscoplasticity*, Advances in Applied Mechanics, vol. 9, Academic Press, New York.
7. Rakhmatullin, KhA & Demyanov, YuA 1961, *Strength under Intensive Short-Time Loads*, Fizmatgiz, Moscow. (In Russian)
8. Rakhmatullin, KhA 1945, 'On Propagation of the Unloading Wave', *PMM*, vol. 9, no. 1, pp. 15-24.
9. Rakhmatullin, KhA & Shapiro, GI 1948, 'On Propagation of Plane Elasto-Plastic Waves', *PMM*, vol. 12, no. 4, pp. 369-374.
10. Taylor, GI 1942, 'The Plastic Wave in a Wire Extended by an Impact Load'. *British Official Report RC329*.
11. Wood, DS 1952, 'On Longitudinal Plane Waves of Elastic-Plastic Strain in Solids'. *Trans.ASME, J. Appl.Mech.*, vol. 19, no. 4, pp. 521-525.

Questions

- 16.1. Comment the proportionality limit and yield limit for the real material. What means coinciding of these limits?
- 16.2. Look for definitions of the shock waves, waves of weak and strong discontinuities. Link these waves.
- 16.3. Comment the difference between the continuous waves (for example, harmonic ones) and discontinuous waves (for example, shock ones).
- 16.4. Consider and compare the utilized in the chapter uni-axial and two-axial statements of the problem on wave propagation in rods.
- 16.5. Remember the Riemann wave definition and main features of this wave. Why it is assumed as the nonlinear wave?
- 16.6. In which way the wave front in the rod can be represented geometrically?
- 16.7. The Taylor wave equations (16.1)-(16.3) and von Karman wave equations (16.5), (16.6) are quite similar. But for derivation of these equations, different coordinate systems – Eulerian and Lagrangean – were used. Comment this fact.
- 16.8. Why the wave velocity in elastoplastic materials is different for the elastic state and for plastic state in the way, that the plastic wave is slower. It is associated with the material choice or reflects the general nature of plastic deformation?

17 Piezoelastic waves. Classical models

Dielectrics. Piezoelectric materials. Polarization. The direct and inverse piezoelectric effects. Basic classical model. Coupled systems of equations. New physical constants.

Let us start with the classification of materials by the attribute of their interaction with an electromagnetic field.

Uppermost, when the material is deformed under action of an electric field and this deformation is not changing with changing the field direction, then this phenomenon is called **the electrostriction**. This phenomenon is observed in all the materials. But it is accepted that classification by this attribute is inconvenient.

If the criterion is chosen as ability to conduct the current, then all the materials can be divided on three groups:

Group 1. Materials with the resistance $< 10^{-5} \Omega \cdot m$ (the conductors).

Group 2. Materials with resistance $> 10^7 \Omega \cdot m$ (the dielectrics).

Group 3. Materials with the resistance $10^{-6} \div 10^9 \Omega \cdot m$ (the semiconductors).

Note 17.1. This classification is conditional in some sense, because the pressure and temperature can change strongly the resistance and translate the material, for example, from conductors to isolators.

Later we will concern with dielectrics, namely this part of dielectrics, which is called **the active dielectrics**. The part includes **ferroelectrics, piezoelectrics, electrooptic materials, electrets and some other materials**.

Because this chapter is devoted to the theory of piezoelectricity, then the analysis of active dielectrics will be naturally narrowed to **piezoelectrics**.

It should be noted that dielectrics are defining through **the polarization**. The polarization as physical phenomenon is introduced by means of the notion of **doublet moment** of the unit volume of material. The doublet moment \vec{P} is the vector quantity and appears when the electric field is studied, which is forming around some finite volume of the material.

The polarization is divided on three different types: **atomic or electronic, ionic, orientational**. Then the total doublet moment is $\vec{P} = \vec{P}_{el} + \vec{P}_{ion} + \vec{P}_{or}$.

The total polarization for the unit volume of material is as follows $\vec{P} = \sum_{k=1}^N \vec{p}^{(k)}$, where N is the number of molecules in the volume.

Definition 17.1. The material with nonzero total electric polarization \vec{P} is called **the electrically polarized**.

Definition 17.2. Usually the ratio of the total electric polarization \vec{P} to the value of the caused the polarization electric field \vec{E} is some internal property of material. It is the nondimensional quantity, has the special notation $\chi_{el} = \left(\frac{|\vec{P}|}{|\vec{E}|} \right)$ and is called **dielectric or electric susceptibility**.

Definition 17.3. The **permittivity constant (dielectric permeability)** ε is defined through the dielectric susceptibility

$$\varepsilon = 1 + 4\pi\chi_{el} \text{ or } \varepsilon = 1 + \chi_{el}. \quad (17.1)$$

The notion of polarization permits to define exactly the dielectrics.

Definition 17.4. Certain substance is **the dielectric**, if it has not the free charges, it does not conduct the electrics and has the electric polarization.

The essence of piezoelectricity phenomenon consists in that in some crystals when the mechanical stresses (more exactly, strains) being acted, the electric polarization arises. And vice versa, the action of the external electric field causes the appearance of mechanical deformations in the crystal.

Please click the advert



What do the telephone handset and
the Celsius thermometer have in common with
the pacemaker and the computer mouse?

They are all
Swedish inventions
used every day worldwide.

Challenge Yourself – Study in Sweden

www.studyinsweden.se

Definition 17.5. The first effect is called **the direct piezoelectric effect**; the second one is called **the inverse piezoelectric effect**.

Note 17.2. The phenomenon when the change of the electric field sign does not change the strain field of crystals was called above **the electrostriction**. It is proper for all the solid dielectrics.

Note 17.3. The inverse to electrostriction phenomenon – a generation in the crystal of the polarization by means of mechanical deformation – depends essentially on the symmetry of crystal lattice of the crystal.

The ability to manifest both effects – the direct and the inverse – singles out the piezoelectrics from the class of dielectrics.

Traditionally the theory of piezoelectricity is substantiated by that many devices, which transform the mechanical energy into the electromechanical one and vice versa, are working basing on the direct and inverse piezoelectric effects.

The physical mechanism of piezoelectricity is well explained on an example of **the sulfide cadmium crystal**. The crystal is built of alternating layers of cadmium and sulfur. In the direction perpendicular to the layers, the ions form chains, in which the sulfur ion is going after cadmium ion. When the electric field or the mechanical deformation being acted, then all the ions are translating identically. It is enough therefore to consider one chain only.

The mechanical model for the chain is assumed in the form of ions linked by two types of springlets – differing by stiffness and lengths – on both ion sides. If the ion charge is q and springlet lengths are l_1, l_2 , then the molecule doublet moment is $p_m = (1/2)q(l_1 - l_2)$. Thus the molecule has its own polarization and is therefore the polar molecule. The crystal is also the polar one.

The direct piezoelectric effect is explained as follows:

when the chain being compressed, then differing springlets are deforming in different way; then distances l_1, l_2 are also changing in different way; the change of distances yields the change of polarization and the forming of full polarization $P = \Delta P_o = (1/2)Nq(\Delta l_1 - \Delta l_2)$, where N is as before the number of molecules in unit volume.

The inverse piezoelectric effect is explained as follows:

the electric field translates the positive and negative ions in opposite directions, therefore the distances between ions are changed; owing to distinguishing springlet stiffness the springlet deformations will differ; in this way the deformations arise in the crystal.

For the simplest model above, the elements of **one-dimensional theory of electroelasticity** can be constructed. At least the constitutive equation can be obtained very simply. It has the form of the linear link among the **stress T** , **strain S** and **electric field E**

$$T = cS - eE, \quad (17.2)$$

where **elastic modulus** c and **piezoelectric modulus** e are evaluated by the formulas

$$c = \frac{N(l_1)^2 K_1 K_2}{K_1 + K_2}; \quad e = \frac{Nl_1 q (K_1 - K_2)}{2(K_1 + K_2)},$$

and K_1, K_2 are the springlet stiffness.

The polarization P is expressed through the electric field and strain linearly also

$$P = \chi_{ion} E + eS. \quad (17.3)$$

The crystal ion susceptibility χ_{ion} is evaluated by the formula $\chi_{ion} = \frac{Nq^2}{K_1 + K_2}$.

The electric induction D depends also linearly on the electric field and strain

$$D = \varepsilon E + eS. \quad (17.4)$$

The dielectric permeability ε is evaluated by the formula $\varepsilon = \varepsilon_o + \chi_{ion} + \chi_{el}$.

This is the simplest model for the asymmetric ion crystal.

But crystals occur of essentially more complicate by the structure and properties. Moreover, so called ceramics is fabricated on the base of crystals. The ceramics is usually the transversally isotropic material, the direction of polarization coincides with the isotropy axis, the subjects of polarization are domains.

Let us cite here the most known piezoelectric materials:

quartz (SiO_2), **sulfide cadmium** (CdS), **zinc oxide** (ZnO), **Rochelle salt**, **aluminium oxide or corund** (Al_2O_3), **barium titanate** ($BaTiO_3$), **lithium niobate** ($LiNbO_3$), **barium and natrium niobate** ($Ba_2NaNb_5O_{15}$), **lithium tantalate** ($LiTaO_3$), **gallium arsenide** ($GaAs$), **bismuth germanate** ($Bi_{12}GeO_{20}$), **different ceramics**.

Remember that materials can be divided on four groups:

1. monocrystalline; 2. polycrystalline; 3. amorphous; 4. amorphous-crystalline.

Definition 17.6. The monocrystalline materials or monocrystals or crystals are materials, which symmetrically and in some order are formed of atoms. This ordering and symmetry are manifesting in existence of some spatial structure of constructing the crystal matter, which is called **the crystal lattice**.

Not very strongly, the presence of the crystal lattice can be meant that the matter is formed of identical periodically repeated cells.

Definition 17.7. The polycrystalline materials are formed of the large number of small crystalline grains (so called **crystallites**) which are oriented randomly and are usually isotropic. First of all, metals can be included into this class of materials.

Definition 17.8. The ceramics (ceramic materials) are also the polycrystalline materials. Grains (crystallites) are assumed to be mono-crystals; their sizes are measured from a fraction of micron to tens microns.

The crystal lattice is the base for theoretical description of crystals. The very useful notion is **the Bravais lattice**. Within the framework of this notion, the classification exists, which includes seven crystalline systems:

1. Triclinic system. 2. Monoclinic system. 3. Rhombic system. 4. Tetragonal system. 5. Trigonal system. 6. Hexagonal system. 7. Cubic system.

Altogether, the 14 types of Bravais lattices and 32 crystalline classes are distinguishing with each other.

It should be noted that the attention to crystals is caused by that the piezoelectricity phenomenon is observed just in crystals.

Please click the advert



Sharp Minds - Bright Ideas!

Employees at FOSS Analytical A/S are living proof of the company value - First - using new inventions to make dedicated solutions for our customers. With sharp minds and cross functional teamwork, we constantly strive to develop new unique products - Would you like to join our team?

FOSS works diligently with innovation and development as basis for its growth. It is reflected in the fact that more than 200 of the 1200 employees in FOSS work with Research & Development in Scandinavia and USA. Engineers at FOSS work in production, development and marketing, within a wide range of different fields, i.e. Chemistry, Electronics, Mechanics, Software, Optics, Microbiology, Chemometrics.

We offer
A challenging job in an international and innovative company that is leading in its field. You will get the opportunity to work with the most advanced technology together with highly skilled colleagues.

Read more about FOSS at www.foss.dk - or go directly to our student site www.foss.dk/sharpminds where you can learn more about your possibilities of working together with us on projects, your thesis etc.

Dedicated Analytical Solutions

FOSS
 Slangerupgade 69
 3400 Hillerød
 Tel. +45 70103370
www.foss.dk

The Family owned FOSS group is the world leader as supplier of dedicated, high-tech analytical solutions which measure and control the quality and production of agricultural, food, pharmaceutical and chemical products. Main activities are initiated from Denmark, Sweden and USA with headquarters domiciled in Hillerød, DK. The products are marketed globally by 23 sales companies and an extensive net of distributors. In line with the corevalue to be 'First', the company intends to expand its market position.



It is well-known that only in 20 of 32 crystalline classes the piezoeffect is possible. For that, ten classes describe the non-polar crystals and ten – polar crystals. These polar crystals are including into the class of segnetoelectrics.

Let us start now with the basic thermodynamic parameters in the classical model of piezoelectricity.

The first two parameters are the parameters of the classical elastic medium – **the Kirchhoff stress tensor** t_{ik} and **the Cauchy-Green strain tensor** ε_{ik} . They form the ordered pair of parameters and both are tensors of the second order. The fields of stresses and strains assume an existence of the third field – **displacement vector field** $\vec{u} = \{u_k\}$.

But in the piezoactive medium, the fields of electromagnetic nature exist. Therefore, the new thermodynamical parameters should be introduced. Two of them are distinguished. They form also the ordered pair – **the vector of electric field intensity** \vec{E} and **the vector of electric induction** \vec{D} . Also additionally **the vector of the full electric polarization** \vec{P} should be introduced.

Thus, the introduced four parameters – the Kirchhoff stress tensor t_{ik} , the Cauchy-Green strain tensor ε_{ik} , the vector of electric field intensity \vec{E} , the vector of electric induction \vec{D} – form the basis for some generalization of the classical theory of elasticity.

The theory of elasticity is constructed by four balance equations – mass, momentum, momentum of momentum, energy. The theory of piezoelectricity saves three first equations of the theory of elasticity in the unchanged form. It is assumed that all the peculiarities of piezoelectricity of the medium can be taken into account in the energy balance equation.

Note 17.4. Such neglecting the electric side of the deformation process is not full and is substantiated by that under not high levels of electric fields the mechanical and electromagnetic effects can be separated.

The mentioned separation is realized in the way, that the general system of Maxwell equations for media with polarization

$$\operatorname{div} \vec{D} = \rho, \quad \operatorname{rot} \vec{E} = -\frac{\partial \vec{B}}{\partial t}, \quad \operatorname{rot} \vec{H} = \frac{\partial \vec{D}}{\partial t} + \vec{j}, \quad \operatorname{div} \vec{B} = 0. \quad (17.5)$$

(here ρ, \vec{j} are **the density of free charges** and **the density of the current of free charges**, respectively) is not used in the full form.

The equations of forced electrostatics are usually used, in which the vector of electric induction \vec{D} , the vector of electric field intensity \vec{E} , and the scalar electric potential φ depend on time in the acoustic frequency range

$$\operatorname{div} \vec{D} = 0, \quad \operatorname{rot} \vec{E} = 0, \quad \vec{E} = -\operatorname{grad} \varphi. \quad (17.6)$$

The equations (17.6) together with the usual motion equations from the theory of elasticity

$$\sigma_{ik,k} = \rho \frac{\partial^2 u_i}{\partial t^2} \quad (17.7)$$

(here the Lagrange stress tensor is written, it is usually used in the linear theory) form the first part of the basic equations describing the deformation of piezoelastic materials.

The second part includes the linear Cauchy relationships (the linear representation of the Green strain tensor through the displacement vector)

$$\varepsilon_{ik} = \frac{1}{2}(u_{i,k} + u_{k,i}). \quad (17.8)$$

The full system must besides equations (17.6)-(17.8) include the constitutive equations.

The standard way to obtain the constitutive equations for an arbitrary piezoelectric medium consists in representation of internal energy of the medium as the function of two independent thermo

dynamical parameters – the Cauchy-Green strain tensor with components ε_{ik} and the vector of electric field intensity with components E_m

$$\mathcal{U} = \mathcal{U}(\varepsilon_{ik}, E_m) = \frac{1}{2}(\sigma_{ik}\varepsilon_{ik} + E_m D_m). \quad (17.9)$$

Note 17.5. From equation (17.9), both nonlinear and linear constitutive equations follow.

To obtain the linear constitutive equations, the internal energy like to the elastic, thermoelastic and other cases is expanded into Taylor series. Then the constitutive equations are as follows

$$\sigma_k = c_{iklm}\varepsilon_{lm} - e_{ikn}E_n, \quad D_m = \tilde{\varepsilon}_{mn}E_n + e_{mkn}\varepsilon_{kn}. \quad (17.10)$$

The formulas

$$c_{iklm} = \left(\frac{\partial^2}{\partial \varepsilon_{ik} \partial \varepsilon_{lm}} \right)_{\varepsilon, E = \text{const}} \mathcal{U} \delta_{ii} \delta_{kk} \delta_{ll} \delta_{mm} = c_{lmik}, \quad (17.11)$$

$$e_{ikm} = \left(\frac{\partial^2}{\partial \varepsilon_{km} \partial E_i} \right)_{\varepsilon, E = \text{const}} \mathcal{U} \delta_{ii} \delta_{kk} \delta_{mm} = e_{imk}, \quad (17.12)$$

$$\tilde{\varepsilon}_{mn} = \left(\frac{\partial^2}{\partial E_m \partial E_n} \right)_{\varepsilon, E = \text{const}} \mathcal{U} \delta_{mm} \delta_{nn} = \tilde{\varepsilon}_{nm}, \quad (17.13)$$

are valid for the physical constants.

Note 17.6. These formulas are never used for determination of constants and are always used for considerations relative to decreasing the number of independent constants by considering the properties of tensor symmetry.

Thus in the general case, the linear piezoelastic material is characterized by

**21 independent elastic constants,
18 independent piezoelectric constants,
6 independent dielectric permeabilities.**

The correlation between the symmetry state (the form of crystal lattice) and the physical constants is described in many books on piezoelasticity. For this purpose, the shown below matrix representation is utilized.

Note 17.7. Any additional symmetry decreases the number of independent physical constants. Particularly, a presence the symmetry center causes the absence in the material of the piezoelasticity effects.

$$\begin{pmatrix} c_{11} & c_{12} & c_{13} & c_{14} & c_{15} & c_{16} & e_{11} & e_{12} & e_{13} \\ c_{12} & c_{22} & c_{23} & c_{24} & c_{25} & c_{26} & e_{21} & e_{22} & e_{23} \\ c_{13} & c_{23} & c_{33} & c_{43} & c_{53} & c_{63} & e_{31} & e_{32} & e_{33} \\ c_{14} & c_{24} & c_{43} & c_{44} & c_{45} & c_{46} & e_{41} & e_{42} & e_{43} \\ c_{15} & c_{25} & c_{35} & c_{45} & c_{55} & c_{56} & e_{51} & e_{54} & e_{53} \\ c_{16} & c_{26} & c_{36} & c_{46} & c_{56} & c_{66} & e_{61} & e_{62} & e_{63} \\ e_{11} & e_{12} & e_{13} & e_{14} & e_{15} & e_{16} & \tilde{\epsilon}_{11} & \tilde{\epsilon}_{12} & \tilde{\epsilon}_{13} \\ e_{21} & e_{22} & e_{23} & e_{24} & e_{25} & e_{26} & \tilde{\epsilon}_{12} & \tilde{\epsilon}_{22} & \tilde{\epsilon}_{23} \\ e_{31} & e_{32} & e_{33} & e_{34} & e_{35} & e_{36} & \tilde{\epsilon}_{13} & \tilde{\epsilon}_{23} & \tilde{\epsilon}_{33} \end{pmatrix}$$

Please click the advert

The Wake

the only emission we want to leave behind

Low-speed Engines Medium-speed Engines Turbochargers Propellers Propulsion Packages PrimeServ

The design of eco-friendly marine power and propulsion solutions is crucial for MAN Diesel & Turbo. Power competencies are offered with the world's largest engine programme – having outputs spanning from 450 to 87,220 kW per engine. Get up front! Find out more at www.mandieselturbo.com

Engineering the Future – since 1758.

MAN Diesel & Turbo



Download free ebooks at bookboon.com

The matrix above corresponds to the triclinic system (with number of constants $21+18+6=45$).

The middle by number of constants ($9+3+3=15$) is the rhombic system 222

$$\begin{pmatrix} c_{11} & c_{12} & c_{13} & 0 & 0 & 0 & 0 & 0 & 0 \\ c_{12} & c_{22} & c_{23} & 0 & 0 & 0 & 0 & 0 & 0 \\ c_{13} & c_{23} & c_{33} & 0 & 0 & 0 & 0 & 0 & 0 \\ 0 & 0 & 0 & c_{44} & 0 & 0 & e_{14} & 0 & 0 \\ 0 & 0 & 0 & 0 & c_{55} & 0 & 0 & e_{25} & 0 \\ 0 & 0 & 0 & 0 & 0 & c_{66} & 0 & 0 & e_{36} \\ 0 & 0 & 0 & e_{14} & 0 & 0 & \tilde{\epsilon}_{11} & 0 & 0 \\ 0 & 0 & 0 & 0 & e_{25} & 0 & 0 & \tilde{\epsilon}_{22} & 0 \\ 0 & 0 & 0 & 0 & 0 & e_{36} & 0 & 0 & \tilde{\epsilon}_{33} \end{pmatrix}$$

The most symmetric cubic system (with number of constants $3+1+1=5$) is characterized by the matrix

$$\begin{pmatrix} c_{11} & c_{12} & c_{12} & 0 & 0 & 0 & 0 & 0 & 0 \\ c_{12} & c_{11} & c_{12} & 0 & 0 & 0 & 0 & 0 & 0 \\ c_{12} & c_{12} & c_{11} & 0 & 0 & 0 & 0 & 0 & 0 \\ 0 & 0 & 0 & c_{44} & 0 & 0 & e_{14} & 0 & 0 \\ 0 & 0 & 0 & 0 & c_{44} & 0 & 0 & e_{14} & 0 \\ 0 & 0 & 0 & 0 & 0 & c_{44} & 0 & 0 & e_{14} \\ 0 & 0 & 0 & e_{14} & 0 & 0 & \tilde{\epsilon}_{11} & 0 & 0 \\ 0 & 0 & 0 & 0 & e_{14} & 0 & 0 & \tilde{\epsilon}_{11} & 0 \\ 0 & 0 & 0 & 0 & 0 & e_{14} & 0 & 0 & \tilde{\epsilon}_{11} \end{pmatrix}$$

It is time at this place to discuss the problem of new physical constants – **the piezoelectric moduli and dielectric permeability moduli.**

Let us start with dimensions – the piezoelectric moduli are measured in $C/m^2 = s \cdot A \cdot m^{-2}$, they can be different signs and take the values in the range $(-10;10)$; the dielectric permeability moduli are measured in $F/m = s^4 \cdot A^2 \cdot m^{-3} \cdot kg^{-1}$ and takes usually values of the order $10^{11} - 10^{13} F/m$.

Values of these moduli for some frequently used materials are taken from (Dieulesaint, E & Royer, D 1974) and shown in tables below.

material	piezoelectric modulus C/m^2						dielectric permeability $10^{-11} F/m$	
	e_{11}	e_{14}	e_{15}	e_{22}	e_{31}	e_{33}	$\tilde{\epsilon}_{11}$	$\tilde{\epsilon}_{33}$
trigonal system								
Litium niobate	0	0	3.7	2.5	0.2	1.3	38.9	25.7
Litium tantalate	0	0	2.6	1.6	0	1.9	36.3	38.1
α -quartz	0.17	-0.04	0	0	0	0	3.92	4.1

Table 17.1. Values of piezoelectric constants and dielectric permeabilities for crystals of the trigonal system

material	piezoelectric modulus C/m^2					dielectric permeabilities $10^{-11} F/m$		
	e_{15}	e_{24}	e_{31}	e_{32}	e_{33}	$\tilde{\epsilon}_{11}$	$\tilde{\epsilon}_{22}$	$\tilde{\epsilon}_{33}$
rhombic system								
Barium and natrium niobate	2.8	3.4	-0.4	-0.3	4.3	196	201	28

Table 17.2. Values of piezoelectric constants and dielectric permeabilities for crystals of the rhombic system

material cubic system	piezoelectric modulus C/m^2	dielectric permeability $10^{-11} F/m$
Gallium arsenide	-0.16	9.73
Bismuth germanate	0.99	34.2

Table 17.3. Values of piezoelectric constant and dielectric permeability for crystals of the cubic system

Thus, the basic equations of the theory of piezoelectricity are known. Let write them together once again

$$\operatorname{div} \vec{D} = \rho, \quad \operatorname{rot} \vec{E} = -\frac{\partial \vec{B}}{\partial t}, \quad \operatorname{rot} \vec{H} = \frac{\partial \vec{D}}{\partial t} + \vec{j}, \quad \operatorname{div} \vec{B} = 0, \tag{17.14}$$

$$\sigma_{ik,k} = \rho \frac{\partial^2 u_i}{\partial t^2}, \quad \epsilon_{ik} = \frac{1}{2}(u_{i,k} + u_{k,i}), \quad \sigma_{ik} = c_{iklm} \epsilon_{lm} - e_{ikn} E_n, \quad D_m = \tilde{\epsilon}_{mn} E_n + e_{mkn} \epsilon_{kn}.$$

Here we are interesting in waves. In the general case, these equations must be solved as a coupled system. The wave solution will consists of two types of waves:

**the piezoelastic waves accompanying with the electric field and
the electromagnetic waves accompanying with the mechanical deformation.**

Usually the velocities of piezoelastic waves are five orders less of the velocities of electromagnetic waves.

Thus the interaction between these two types of waves occurs in practice very small and it can be neglected. Therefore the piezoelastic waves can be considered independently in the quasi-static approximation. In next analysis of piezoelastic waves equation (17.14) will be changed on the corresponding to this approximation equations

$$\operatorname{div} \vec{D} = 0, \quad \operatorname{rot} \vec{E} = 0, \quad \vec{E} = -\operatorname{grad} \varphi.$$

Comments

As a rule, some part of people working in material science is not well informed in electromagnetism. Therefore, this chapter can be considered as an introductory one for this part of readers, for which the first law of the electrician is written:

**do not touch the bare wire with wet hands,
because the wire can become rusty.**

Please click the advert

Technical training on *WHAT* you need, *WHEN* you need it

At IDC Technologies we can tailor our technical and engineering training workshops to suit your needs. We have extensive experience in training technical and engineering staff and have trained people in organisations such as General Motors, Shell, Siemens, BHP and Honeywell to name a few.

Our onsite training is cost effective, convenient and completely customisable to the technical and engineering areas you want covered. Our workshops are all comprehensive hands-on learning experiences with ample time given to practical sessions and demonstrations. We communicate well to ensure that workshop content and timing match the knowledge, skills, and abilities of the participants.

We run onsite training all year round and hold the workshops on your premises or a venue of your choice for your convenience.

For a no obligation proposal, contact us today at training@idc-online.com or visit our website for more information: www.idc-online.com/onsite/

Phone: **+61 8 9321 1702**
 Email: training@idc-online.com
 Website: www.idc-online.com



Since the piezoelectricity phenomenon has been discovered at 1880 by Pierre and Jacques Curie in quartz crystals, then it seems to be worthy to show the way to discovery (Dieulesaint, E & Royer, D 1974).

A base for the discovery was the Curie principles relative to symmetry and antisymmetry of causes and effects.

The first principle: The phenomenon has all the symmetry elements, which have the causes generating the phenomenon (effects can have more high symmetry than causes).

The second principle: Asymmetry of phenomenon is determined by asymmetry of causes generated the phenomenon. In notions of these principles, the direct piezoelectric effect is the phenomenon of appearance of electric polarization caused by the compression of crystals. Because the compression has the symmetry center, then such a center must be absent in the crystal. Curie's have been concluded that piezoelectric properties can be in the crystals only, which have not the symmetry center. Experimental observations has been justified this prediction.

Let us add some historical facts. Curie's have been described the experiments in which the electric charges have been appeared on the crystal surfaces and the charge values have been proportional to the applied compression, when the quartz crystals were mechanically compressed. The removal of mechanical loading has been accompanied by electric charges loss. This phenomenon was called the direct piezoelectric effect. In 1881 Lippmann basing on thermodynamic considerations has been predicted a possibility of the inverse piezoelectric effect: being under action of electric field, the crystals must be deformed. Just this year Curie's have been confirmed experimentally an existence of the inverse piezoelectric effect.

Further a few tens years the piezoelectric effect was treated as the scientific curios thing and has not been even mentioned in the textbooks on physics, not being the subject of scientific interest. Despite of that Pockels in 1894 has been analyzed very thoroughly the piezoeffects in many crystals. In 1928 only Voigt has been written the equations for piezocrystal deformations.

The scientific interest to piezoelectricity has been appeared in time of the First World War owing to Langevin works, in which this phenomenon was the basis of the device for detecting the location of submarines. From the presentday point of view, this was the simplest sonic transmitter and simultaneously the receiver of acoustic waves. The base for the device was formed by the piezoelectric plates, the principle of working the device was called **the location**, the device was called **the radar**.

Later a new important application for piezoelectric crystals has been found. The resonant elements were discovered. They stabilize and control the frequency in radiotechnical devices. Basing on these elements the etalons of time very high precision and stability were created, which actually are called **the quartz clock**. The same piezoresonators are used as the electric filters in different fields of communication.

Thus, two different properties of piezocrystals are now utilized:

**the ability to transform the energy of elastic deformations
into the electric signals and the stable resonance ability.**

Next comment is associated with the crystal structure. From point of view of geometry, the crystalline materials are formed of crystals having the form of convex polygons. Each crystalline material is usually formed of identical crystals.

For example, quartz is formed of polygons with the form of elongated hexagonal prisms extended at ends by pyramids. Two neighbouring sides form the angle 120° , number of sides is six, and they are not all equal with each other. The angle between pyramid side and prism side is equal to $141^\circ 47'$; the angle between two neighbouring sides of pyramid is equal to $133^\circ 44'$.

In mechanics and physics the lack of correspondence exists in denotation of strains and dielectric permeability – the one and the same Greek letter ε is used. Usually mechanicians are proposing for dielectric permeability some additional indexes.

And final comment to the quasi-static approximation. It includes also the energy consideration. For piezoelastic waves their electromagnetic energy is negligible small comparing with their elastic energy. And vice versa, for electromagnetic waves their elastic energy is negligible small comparing with their electromagnetic energy.

Further reading

1. Balakirev, MK & Gilinsky, IA 1982, *Waves in piezocrystals*, Nauka, Novosibirsk. (In Russian)
2. Dieulesaint, E & Royer, D 1974, *Ondes elastiques dans les solides. Application au traitement du signal*. Masson et Cie, Paris. (In French)
3. Grinchenko, VT, Ulitko, AF & Shulga, NA 1989, *Electroelasticity*. Vol.5. Edition in 5 volumes. Mechanics of Couples Fields in Structural Members, Naukova Dumka, Kiev. (In Russian)
4. Hippel, AR 1954, *Dielectrics and Waves*, John Wiley & Sons, New York.
5. Lines, ME & Glass, AM 1977, *Principles and Application of Ferroelectrics and Related Materials*, Clarendon Press, Oxford.
6. Mason, WP 1981, 'Piezoelectricity, its history and applications', *J.Acoust.Soc.Amer.*, vol. 70, no. 6, pp. 1561-1567.
7. Maugin, GA 1985, *Nonlinear Electromechanical Effects and Applications*, Academic Press, New York.
8. Maugin, GA 1988, *Continuum Mechanics of Electromagnetic Solids*, North-Holland, Amsterdam.
9. Nye, JP 1961, *Proprietes physiques des cristaux*, Dunod, Paris. (In French)
10. *Physical Acoustics* 1970, Mason, WP & Thurston, RN (eds), in 10 vols. Academic Press, New York.
11. Tiersten, HF 1969, *Linear Piezoelectric Plate Vibrations*, Plenum Press, New York.
12. Tiersten, HF 1984, *Electric Fields, Deformable Semiconductors and Piezoelectric Devices*. In: *The Mechanical Behavior of Electromagnetic Solid Continua*. Maugin, GA (ed), North-Holland, Amsterdam.

Questions

- 17.1. Let the distribution of charges $\rho(x_1, x_2, x_3)$ is known. Write the monopole moment, the dipole moment, and the quadrupole moment.
- 17.2. Define the physical dipole and the mathematical dipole.
- 17.3. Formulate the distinction between crystalline and amorphous materials on an example of heating and next cooling.
- 17.4. What is the basis of the complex crystal lattice? Can the complex crystal lattice consists of a few Bravais lattices?
- 17.5. List the main types of lattices within the framework of one crystal system.
- 17.6. List and comment the symmetry elements: symmetry axis, symmetry center, inverse axis.
- 17.7. Formulate the distinction between the general and approximate statement of the wave propagation problem in piezo-elasticity and comment it.

18 Piezoelastic plane waves

Basic classical model. Wave equations for new kinds of materials with new levels of physical properties symmetry. Plane waves. Christoffel tensor and Christoffel equations. Quasi-longitudinal and quasi-transverse plane waves. Piezo-electrically active waves. Coefficient of electromechanical coupling. Main features of plane waves within the framework of the basic model.

The wave equations and the basic wave effects are the main goal of this book. But some chapters-lectures are devoted to fundamentals of the particular theory. The prior chapter-lecture was just such one, it was concerned the theory of piezoelasticity and discusses waves quite in passing.

Let us remember the novelty of this model comparing with all prior models:

The theory of piezoelasticity is concerning mainly not on materials with classical symmetry – isotropic, transversely isotropic (monotropic) and orthotropic. This theory introduces into consideration new materials with three kinds of physical properties – the elastic constants, the piezoelectric constants, the dielectric permeabilities or the dielectric susceptibilities – and takes into account the diverse levels of symmetry of physical properties, which include the materials with the classical symmetry as a very particular case.

Please click the advert

I joined MITAS because
I wanted **real responsibility**

The Graduate Programme
for Engineers and Geoscientists
Maersk.com/Mitas



Month 16

I was a construction supervisor in the North Sea advising and helping foremen solve problems

Real work
International opportunities
Three work placements





Download free ebooks at bookboon.com

Show now the basic wave equations. Firstly the basic system from the prior chapter-lecture should be written in slightly changed form

$$\operatorname{div} \vec{D} = 0, \quad \operatorname{rot} \vec{E} = 0, \quad \vec{E} = -\operatorname{grad} \varphi, \quad \operatorname{div} \sigma = \rho \ddot{\vec{u}},$$

$$\sigma_k = c_{iklm} u_{l,m} - e_{ikn} E_n, \quad D_m = \tilde{\epsilon}_{mn} E_n + e_{mkn} u_{k,n}.$$

These equations can be transformed into two coupled systems of dynamic equations

$$\operatorname{div} (c_{iklm} u_{l,m} + e_{ikn} \varphi_{,n}) = \rho \ddot{u}_i, \quad \operatorname{div} (\tilde{\epsilon}_{mn} \varphi_{,n} - e_{mkn} u_{k,n}) = 0,$$

or

$$c_{iklm} u_{l,mk} + e_{ikn} \varphi_{,nk} = \rho \ddot{u}_i, \quad \tilde{\epsilon}_{mn} \varphi_{,nm} - e_{mkn} u_{k,nn} = 0. \quad (18.1)$$

The obtained four equations will describe the waves too.

Note 18.1. The condition $\operatorname{rot} \vec{E} = 0$ means that the vector \vec{E} is solenoidal one and this fact should be taken into account in (18.1).

The concrete form of system (18.1) is depending on the symmetry of chosen material. For example, if a ceramic piezoelectric of the hexagonal class $6mm$ with the vector of preliminary polarization in direction of the applicate axis is considered, then dynamic processes will be described by the coupled system of four equations relative to displacements u_k and electric potential φ , which will be the simplified variant of system (18.1)

$$\frac{1}{2}(c_{11} + c_{12}) \operatorname{grad} \operatorname{div} \vec{u} + \frac{1}{2}(c_{11} - c_{12}) \Delta \vec{u} + \left[c_{44} - \frac{1}{2}(c_{11} - c_{12}) \right] (\vec{u}_{,33} + \Delta \vec{u} \cdot \vec{x}_3^o) + \quad (18.2)$$

$$+ \left[c_{44} + c_{13} - \frac{1}{2}(c_{11} - c_{12}) \right] (\operatorname{grad} u_{3,3} + \operatorname{div} \vec{u} \cdot \vec{x}_3^o) + (c_{11} + c_{33} - 4c_{44} - c_{13}) \vec{u}_{,33} \cdot \vec{x}_3^o - \rho \ddot{\vec{u}} =$$

$$= -e_{15} \Delta \varphi \cdot \vec{x}_3^o - (e_{31} + e_{15}) \operatorname{grad} \varphi_{,3} - (e_{33} - e_1 - 2e_{15}) \varphi_{,33} \cdot \vec{x}_3^o,$$

$$\tilde{\epsilon}_{11} \Delta \varphi + (\tilde{\epsilon}_{33} - \tilde{\epsilon}_{11}) \varphi_{,33} = e_{15} \Delta u_3 + (e_{31} + e_{15}) \operatorname{div} \vec{u}_{,3} + (e_{33} - e_{31} - 2e_{15}) u_{3,33}. \quad (18.3)$$

Here \vec{x}_i^o ($i = 1; 2; 3$) are the ords of Cartesian coordinate system.

Note 18.2. The distinction of the translatory isotropy from the isotropy is small for this ceramics. But nevertheless the model of the isotropic medium could be not true.

Analysis of the problem (18.2),(18.3) seems to be more convenient after considering the more simple problems for plane waves.

Note 18.3. Some fragments from the listed in bibliography books are used in the chapter. This remark is related not only to this chapter.

So, consider now the equations (18.1) and assume that the solution is looking for the plane wave propagating in direction defined by the unit normal vector $\vec{n}^o = n_1 \vec{x}_1^o + n_2 \vec{x}_2^o + n_3 \vec{x}_3^o$.

Next step consists in representation of all four unknown functions in the form of D'Alembert waves

$$u_k(x_1, x_3, t) = u_k^o F(\xi), \quad \varphi(x_1, x_3, t) = \varphi^o F(\xi),$$

where the wave phase $\xi = t - \frac{\vec{n}^o \cdot \vec{r}}{v_{ph}}$ ($\vec{r} = (x_1, x_1, x_3)$) is introduced and F is the arbitrary function.

It should be additionally assumed that the electric field is longitudinal one

$$E_k = -(\partial\varphi/\partial x_k) = (n_k/v_{ph})\varphi^o F' \left(t - \frac{\vec{n}^o \cdot \vec{r}}{v_{ph}} \right).$$

Further the classical procedure of deriving the Christoffel equations should be repeated. Finally the coupled system of equations can be written in the form

$$\Gamma_{ik} u_k^o + \gamma_i \varphi^o = \rho (v_{ph})^2 u_i^o, \quad \gamma_i u_i^o - \tilde{\varepsilon} \varphi^o = 0, \quad (18.4)$$

where notations are adopted $\Gamma_{ik} = c_{iklm} n_l n_m$, $\gamma_i = e_{ikn} n_k n_m$, $\tilde{\varepsilon} = \tilde{\varepsilon}_{ik} n_i n_k$.

Note 18.4. The tensor Γ_{ik} is the classical Christoffel tensor for elastic medium.

If to exclude the amplitude of electric potential φ^o in equations (18.4), then the piezoelastic analog of classical Christoffel equations for elastic medium can be obtained in the form

$$\left(\Gamma_{ik} + \frac{\gamma_i \gamma_k}{\tilde{\varepsilon}} \right) u_k^o = \rho (v_{ph})^2 u_i^o. \quad (18.5)$$

First of all, the piezoelastic analog of the Christoffel tensor can be introduced

$$\Gamma_{ik}^{piezo} = \Gamma_{ik} + \frac{\gamma_i \gamma_k}{\tilde{\varepsilon}}. \quad (18.6)$$

This tensor is always the symmetric one.

By the way of taking into account formula (18.6), new equations (18.5) can be reduced to the classical Christoffel equation with some new "elastic" moduli

$$\Gamma_{ik}^{piezo} u_k^o = \rho (v_{ph})^2 u_i^o$$

For this case, the general statements are valid:

Statement 1. Three independent plane waves with different phase velocities can propagate.

Statement 2. These waves propagate in directions which are mutually perpendicular.

Statement 3. The wave propagating in direction most close to the polarization direction is called the quasi-longitudinal wave.

Statement 4. Other two waves are called the quasi-transverse waves.

As a rule, in the wave analysis the general case of anisotropy is practically not considered. For evaluation of moduli (18.6) for particular cases, three representations are used

$$\Gamma_{ik} = c_{i11k} (n_1)^2 + c_{i22k} (n_2)^2 + c_{i33k} (n_3)^2 + (c_{i12k} + c_{i21k}) n_1 n_2 + (c_{i13k} + c_{i31k}) n_1 n_3 + (c_{i32k} + c_{i23k}) n_2 n_3$$

$$\gamma_k = e_{11k} (n_1)^2 + e_{22k} (n_2)^2 + e_{33k} (n_3)^2 + (e_{12k} + e_{21k}) n_1 n_2 + (e_{13k} + e_{31k}) n_1 n_3 + (e_{32k} + e_{23k}) n_2 n_3,$$

$$\tilde{\varepsilon} = \tilde{\varepsilon}_{11} (n_1)^2 + \tilde{\varepsilon}_{22} (n_2)^2 + \tilde{\varepsilon}_{33} (n_3)^2 + (\tilde{\varepsilon}_{12} + \tilde{\varepsilon}_{21}) n_1 n_2 + (\tilde{\varepsilon}_{13} + \tilde{\varepsilon}_{31}) n_1 n_3 + (\tilde{\varepsilon}_{32} + \tilde{\varepsilon}_{23}) n_2 n_3.$$

Please click the advert

The advertisement features a grid of four images. The top-left image shows a person in a white shirt working at a computer workstation with a green chair. The top-right image shows two women in professional attire, one in a pink shirt and one in a white turtleneck, engaged in a conversation. The bottom-left image shows a man in a dark suit holding a document. The bottom-right image shows a modern, multi-story building with illuminated windows at night. A large, stylized blue wave graphic curves across the bottom of the collage. The Oticon logo is positioned in the bottom right corner of the advertisement.

www.job.oticon.dk

oticon
PEOPLE FIRST

Download free ebooks at bookboon.com

Finally basing on the Christoffel equation (18.5) the very important conclusion can be formulated:

in the fixed material, the number and types of piezoelectric plane waves (when the electric field is acting) and elastic plane waves (when the electric field is absent) are identical; the piezoelectric waves and corresponding elastic waves will distinguish by amplitudes and phase velocities only.

Consider three simple examples of evaluation of phase velocities for some piezoelectric crystals.

Example 1. Bismuth germanate crystal $Bi_{12}GeO_{20}$ of the cubic symmetry.

In this case, the three only piezoelectric moduli $e_{14} = e_{25} = e_{36}$ are nonzero and

$$\gamma_1 = 2e_{14}n_2n_3, \gamma_2 = 2e_{14}n_1n_3, \gamma_3 = 2e_{14}n_1n_2.$$

Consider the plane Ox_1x_2 , for which $n_1 = \cos \phi, n_2 = \sin \phi, n_3 = 0$. Then $\gamma_1 = \gamma_2 = 0, \gamma_3 = e_{14} \sin 2\phi$.

Also, for the plane under consideration three nonzero components of the Christoffel tensor rest unchanged $\hat{\Gamma}_{11} = \Gamma_{11}, \hat{\Gamma}_{22} = \Gamma_{22}, \hat{\Gamma}_{12} = \Gamma_{12}$ and only one is changed

$$\hat{\Gamma}_{33} = \Gamma_{33} + \frac{(\gamma_3)^2}{\tilde{\epsilon}_{11}} = c_{44} + \frac{(e_{14})^2}{\tilde{\epsilon}_{11}} \sin^2 2\phi. \quad (18.7)$$

Then two waves – one quasi-longitudinal and one quasi-transverse – are identical with corresponding elastic waves and are propagating without the piezoelectric effect with phase velocities

$$v_{ph}^{(1)} = \sqrt{\frac{1}{\rho} \left(c_{11} + c_{44} + \sqrt{(c_{11} - c_{44})^2 \cos^2 2\phi + (c_{12} - c_{44})^2 \sin^2 \phi} \right)},$$

$$v_{ph}^{(2)} = \sqrt{\frac{1}{\rho} \left(c_{11} + c_{44} - \sqrt{(c_{11} - c_{44})^2 \cos^2 2\phi + (c_{12} - c_{44})^2 \sin^2 \phi} \right)}.$$

These velocities should be commented.

Note 18.5. The first wave corresponds to the longitudinal wave and the second one corresponds to the transverse wave for $\phi = 0; \pi/2$ only. Then $v_{ph}^{(1)} = \sqrt{c_{11}/\rho}$ and $v_{ph}^{(2)} = \sqrt{c_{44}/\rho}$.

Note 18.6. It can be noted that these two piezoelectric displacement waves coincide with the corresponding elastic waves, because the displacements in the wave motion are not producing the longitudinal electric field.

The third piezoelectric wave is the transverse one. The corresponding elastic wave is polarized along the appicate axis. It propagates with the phase velocity $v_{ph}^{(3)} = \sqrt{c_{44}/\rho}$ and does not depend on the direction of propagation.

Owing to dependence (18.7) the phase velocity of third piezoelastic wave will be depending on presence of electric field and the direction of propagation

$$v_{ph}^{(3)piezo} = \sqrt{\frac{\hat{\Gamma}_{33}}{\rho}} = v_{ph}^{(3)} \sqrt{1 + \frac{(e_{14})^2}{c_{44}\tilde{\epsilon}_{11}} \sin^2 2\phi}. \quad (18.8)$$

The phase velocities of piezoelastic waves including velocity (18.8) are usually expressed through the constant of electromechanical coupling. This constant for the symmetry class 23, to which the crystal under consideration belongs, has the form

$$K = \frac{e_{14}}{\sqrt{c_{44}\tilde{\epsilon}_{11} + (e_{14})^2}}.$$

Then formula (18.8) is transforming into

$$v_{ph}^{(3)piezo} = v_{ph}^{(3)} \sqrt{1 + \frac{K^2}{1 - K^2} \sin^2 2\phi}. \quad (18.9)$$

Note 18.7. Because the constant K is known for many real crystals, then the formula (18.9) permits to evaluate the maximal percent of exceeding the piezoelastic phase velocity $v_{ph}^{(k)piezo}$ over the corresponding elastic one $v_{ph}^{(k)}$. Particularly, for the Bismuth germanate crystal $K=0.32$ and then $\frac{v_{ph}^{(3)piezo} - v_{ph}^{(3)}}{v_{ph}^{(3)}} \approx \frac{1}{2} K^2 \approx 0.05$. Thus the exceeding comes to 5 % only.

Example 2. Lithium niobate crystal $LiNbO_3$ of the trigonal symmetry.

The waves in the plane Ox_2x_3 are considering. In this case, $n_1 = 0, n_2 = \sin \phi, n_3 = \cos \phi$, the four nonzero piezoelectric moduli $e_{22}, e_{33}, e_{15}, e_{31}$ should be used and

$$\gamma_1 = 0, \quad \gamma_2 = e_{22} \sin^2 \phi + (e_{13} + e_{31}) \sin \phi \cos \phi, \quad \gamma_3 = e_{15} \sin^2 \phi + e_{33} \cos^2 \phi, \quad \tilde{\epsilon} = \tilde{\epsilon}_{11} \sin^2 \phi + \tilde{\epsilon}_{33} \cos^2 \phi.$$

Also, for the plane under consideration only one nonzero component of the Christoffel tensor rests unchanged $\hat{\Gamma}_{11} = \Gamma_{11} = c_{66} \sin^2 \phi + c_{44} \cos^2 \phi + c_{14} \sin 2\phi$ and three components are changed

$$\hat{\Gamma}_{22} = \Gamma_{22} + \frac{(\gamma_2)^2}{\tilde{\epsilon}} = c_{11} \sin^2 \phi + c_{44} \cos^2 \phi - c_{14} \sin 2\phi + \frac{(\gamma_2)^2}{\tilde{\epsilon}},$$

$$\hat{\Gamma}_{23} = \Gamma_{23} + \frac{\gamma_2 \gamma_3}{\tilde{\epsilon}} = -c_{11} \sin^2 \phi + \frac{1}{2}(c_{13} + c_{44}) \sin 2\phi + \frac{\gamma_2 \gamma_3}{\tilde{\epsilon}},$$

$$\hat{\Gamma}_{33} = \Gamma_{33} + \frac{(\gamma_3)^2}{\tilde{\epsilon}} = c_{44} \sin^2 \phi + c_{33} \cos^2 \phi + \frac{(\gamma_3)^2}{\tilde{\epsilon}}.$$

One of three waves – the transverse wave polarized along the abscissa axis – is not piezoelectric active. The phase velocity of this wave $v_{ph}^{(3)piezo}$ coincides with phase velocity of corresponding elastic wave $v_{ph}^{(3)}$

$$v_{ph}^{(3)piezo} = v_{ph}^{(3)} = \sqrt{\frac{c_{66} \sin^2 \phi + c_{44} \cos^2 \phi + c_{14} \sin 2\phi}{\rho}}. \quad (18.10)$$

As it follows from (18.10), the phase velocity of this non-piezoactive wave depends on the angle ϕ .

Two other waves are quasi-longitudinal and quasi-transverse waves in the elastic case and save this property in the piezoelastic case. The corresponding phase velocities in the elastic case are evaluated by the formulas

$$v_{ph}^{(1,2)} = \sqrt{\frac{\Gamma_{22} + \Gamma_{33} \pm \sqrt{(\Gamma_{22} - \Gamma_{33})^2 + 4(\Gamma_{23})^2}}{2\rho}}, \quad (18.11)$$

$$v_{ph}^{(1,2)} = \left\{ c_{44} + c_{11} \sin^2 \phi + c_{33} \cos^2 \phi - c_{14} \sin 2\phi \pm \left[(c_{11} \sin^2 \phi - c_{33} \cos^2 \phi + c_{44} \cos 2\phi - c_{14} \sin 2\phi)^2 + \left((c_{13} + c_{44}) \sin 2\phi - 2c_{14} \sin^2 \phi \right)^2 \right]^{1/2} \right\}^{1/2}.$$

Please click the advert



What do the telephone handset and the Celsius thermometer have in common with the pacemaker and the computer mouse?

They are all Swedish inventions used every day worldwide.

Challenge Yourself – Study in Sweden

www.studyinsweden.se

The quasi-longitudinal and quasi-transverse polarized in the plane Ox_2x_3 piezoelectric waves are piezoelectrically active and their phase velocities should be evaluated by the formulas very similar to (18.11)

$$v_{ph}^{(1,2)piezo} = \sqrt{\frac{\widehat{\Gamma}_{22} + \widehat{\Gamma}_{33} \pm \sqrt{(\widehat{\Gamma}_{22} - \widehat{\Gamma}_{33})^2 + 4(\widehat{\Gamma}_{23})^2}}{2\rho}}.$$

The maximal exceeding the values of velocities for the piezowaves over the corresponding values for elastic waves is about 13%.

Example 3. Zinc oxide crystal ZnO of the hexagonal symmetry.

The waves in the plane Ox_2x_3 are considering. In this case, $n_1 = 0, n_2 = \sin \phi, n_3 = \cos \phi$, the four nonzero piezoelectric moduli $e_{11}, e_{33}, e_{15}, e_{31}$ should be used and

$$\gamma_1 = 0, \gamma_2 = (1/2)(e_{15} + e_{31})\sin 2\phi, \gamma_3 = e_{15}\sin^2 \phi + e_{33}\cos^2 \phi, \tilde{\varepsilon} = \tilde{\varepsilon}_{11}\sin^2 \phi + \tilde{\varepsilon}_{33}\cos^2 \phi.$$

Also, for the plane under consideration only one nonzero component of the Christoffel tensor rests unchanged $\widehat{\Gamma}_{11} = \Gamma_{11} = c_{66}\sin^2 \phi + c_{44}\cos^2 \phi$ and three are changed

$$\widehat{\Gamma}_{22} = \Gamma_{22} + \frac{(\gamma_2)^2}{\tilde{\varepsilon}} = c_{11}\sin^2 \phi + c_{44}\cos^2 \phi + \frac{(\gamma_2)^2}{\tilde{\varepsilon}}, \quad (18.12)$$

$$\widehat{\Gamma}_{23} = \Gamma_{23} + \frac{\gamma_2\gamma_3}{\tilde{\varepsilon}} = \frac{1}{2}(c_{13} + c_{44})\sin 2\phi + \frac{\gamma_2\gamma_3}{\tilde{\varepsilon}},$$

$$\widehat{\Gamma}_{33} = \Gamma_{33} + \frac{(\gamma_3)^2}{\tilde{\varepsilon}} = c_{44}\sin^2 \phi + c_{33}\cos^2 \phi + \frac{(\gamma_3)^2}{\tilde{\varepsilon}}.$$

One of three waves – the transverse wave polarized along the applicate axis – is not piezoelectric active. The phase velocity $v_{ph}^{(3)piezo}$ coincides with phase velocity of corresponding elastic wave $v_{ph}^{(3)}$

$$v_{ph}^{(3)piezo} = v_{ph}^{(3)} = \sqrt{\frac{(1/2)(c_{11} - c_{12})\sin^2 \phi + c_{44}\cos^2 \phi}{\rho}}. \quad (18.13)$$

As it follows from (18.13), the phase velocity of this non-piezoactive wave depends on the angle ϕ .

Two other waves are quasi-longitudinal and quasi-transverse waves in the elastic case and save this property in the piezoelectric case. The corresponding phase velocities in the elastic case are evaluated by the formulas (18.11)

$$v_{ph}^{(1,2)} = \left\{ c_{44} + c_{11}\sin^2 \phi + c_{33}\cos^2 \phi \pm \left[(c_{11}\sin^2 \phi - c_{33}\cos^2 \phi + c_{44}\cos 2\phi)^2 + (c_{13} + c_{44})^2 \sin^2 2\phi \right]^{1/2} \right\}^{1/2}.$$

The polarized in the plane Ox_2x_3 quasi-longitudinal and quasi-transverse piezoelastic waves are piezoelectrically active and their phase velocities should be evaluated by the formulas very similar to (18.11)

$$v_{ph}^{(1,2)piezo} = \sqrt{\frac{\widehat{\Gamma}_{22} + \widehat{\Gamma}_{33} \pm \sqrt{(\widehat{\Gamma}_{22} - \widehat{\Gamma}_{33})^2 + 4(\widehat{\Gamma}_{23})^2}}{2\rho}}, \quad (18.14)$$

but here representations (18.12) should be taken into account.

The maximal exceeding the values of velocities for the piezo-elastic waves over the corresponding values for elastic waves is about 10%.

Thus, the main conclusion from the shown examples can be formulated:

plane waves in piezoactive materials can be piezoactive and not piezoactive, that is, the electric field can effect on these waves or not; as a rule, one or two of three different plane waves are not piezoactive and coincide with the corresponding elastic wave.

Solve now the problem (18.2),(18.3) assuming the solution to be the plane waves propagating in the plane Ox_1x_2 under certain angle to the polarization axis in the direction with the unit vector

$$\vec{n}_g^o = n_1 \vec{x}_1^o + n_3 \vec{x}_3^o = \sin \vartheta \vec{x}_1^o + \cos \vartheta \vec{x}_3^o.$$

Next step consists in representation of all the four unknown functions in the form of D'Alembert waves

$$u_k(x_1, x_3, t) = A_k F(\xi), \quad \varphi(x_1, x_3, t) = A_4 F(\xi), \quad (18.15)$$

where F is the arbitrary function and $\xi = n_1 x_1 + n_3 x_3 - v_{ph} t$ is the wave phase.

Substituting (18.15) into equations (18.2),(18.3) after the standard procedures gives finally three different values for the phase velocities

$$v_{ph}^{(1)} = \sqrt{\frac{q_{11} + q_{22} + \sqrt{(q_{11} - q_{22})^2 + 4(q_{12})^2}}{2\rho}}, \quad (18.16)$$

$$v_{ph}^{(2)} = \sqrt{\frac{q_{11} + q_{22} - \sqrt{(q_{11} - q_{22})^2 + 4(q_{12})^2}}{2\rho}}, \quad (18.17)$$

$$v_{ph}^{(3)} = \sqrt{\frac{(n_1)^2 (c_{11} - c_{12}) + 2(n_3)^2 c_{44}}{2\rho}}, \quad (18.18)$$

where the next notations are used

$$q_{11} = (n_1)^2 c_{11} + (n_3)^2 c_{44} + \frac{(n_1 n_3)^2 (e_{31} + e_{15})^2}{(n_1)^2 \tilde{\epsilon}_{11} + (n_3)^2 \tilde{\epsilon}_{33}}, \quad q_{22} = (n_1)^2 c_{44} + (n_3)^2 c_{33} + \frac{((n_1)^2 e_{15} + (n_3)^2 e_{33})^2}{(n_1)^2 \tilde{\epsilon}_{11} + (n_3)^2 \tilde{\epsilon}_{33}},$$

$$q_{12} = \ln \left[c_{13} + c_{44} + \frac{(e_{13} + e_{15})((n_1)^2 e_{15} + (n_3)^2 e_{33})^2}{(n_1)^2 \tilde{\epsilon}_{11} + (n_3)^2 \tilde{\epsilon}_{33}} \right]$$

The important feature of phase velocities (18.16)-(18.18) is their dependence on the angle ϑ , which determines an incline of the wave front relative to the polarization axis. This angle influences essentially on the piezoelectric coupling of the first two waves. For certain values of the angle, these waves can be at all not piezoactive (not coupled piezoelectrically).

Owing to the form of obtained formulas for the phase velocities and validity the inequality for elastic constants $c_{11} > c_{12}$, the next inequalities for the phase velocities are true

$$(v_{ph}^{(1)})^2, (v_{ph}^{(2)})^2, (v_{ph}^{(3)})^2 > 0, \quad v_{ph}^{(1)} > v_{ph}^{(2)} \geq v_{ph}^{(3)} \quad (\vartheta \in [0; \pi/2]).$$

Finally return to amplitudes from formulas (18.15). They can be evaluated by the classical procedure from obtained algebraic equations, when the representation (18.15) being substituted into the basic equations. As a rule, one of these amplitudes must be arbitrary.

Please click the advert

STUDY FOR YOUR MASTER'S DEGREE

IN THE CRADLE OF SWEDISH ENGINEERING

Chalmers University of Technology conducts research and education in engineering and natural sciences, architecture, technology-related mathematical sciences and nautical sciences. Behind all that Chalmers accomplishes, the aim persists for contributing to a sustainable future – both nationally and globally.

Visit us on Chalmers.se or [Next Stop Chalmers](#) on facebook.



CHALMERS
UNIVERSITY OF TECHNOLOGY

Download free ebooks at bookboon.com

In the present case, the procedure has some simplification, which consists in that the amplitudes for the first two waves and for the third wave are determined as if from independent systems. For the first two waves therefore the amplitudes fulfill the relationships

$$A_1^{(n)} = \frac{q_n + q_{11} - q_{22}}{2q_{12}} A_3^{(n)}, \quad A_2^{(n)} = 0, \quad A_4^{(n)} = \frac{\ln(e_{31} + e_{15}) A_1^{(n)} + (e_{15} (n_1)^2 + e_{33} (n_3)^2) A_3^{(n)}}{\tilde{\epsilon}_{11} (n_1)^2 + \tilde{\epsilon}_{33} (n_3)^2} \quad (n = 1; 2).$$

This means that the amplitude $A_1^{(n)}$ or $A_3^{(n)}$ can be assuming to be the arbitrary quantities. The third wave is characterized by next amplitudes $A_1^{(3)} = A_3^{(3)} = A_4^{(3)} = 0$ and $A_2^{(3)}$ is the arbitrary quantity.

This also means that the first two waves are the quasi-longitudinal and quasi-transverse active piezoelastic waves, that is they are piezoelectrically coupled (they depend on the electric field). The third wave has the phase velocity which does not depend on parameters of electric field and therefore this wave coincides with the corresponding elastic wave.

It should be noted that when the quasi-longitudinal wave being propagated, then particles are displaced almost normal to the wave front, and when the quasi-transverse wave being propagated, then particles are displaced almost parallel to the wave front. The displacement vectors of both waves are mutually orthogonal.

Comments

Owing to formulas (18.5) and (18.6), the effect of electromagnetic field on the phase velocities of piezoelastic waves of displacement can be treated as the change of elastic properties of material in which the waves are propagating. These new elastic moduli can be presented as follows

$$\hat{c}_{nikm} = c_{nikm} + \frac{e_{pni} n_p \cdot e_{qkm} n_q}{\tilde{\epsilon}_{ik} n_i n_k}.$$

It should be noted that these new elastic moduli can be called the elastic ones conditionally only, because they depend on the direction of wave propagation (what is forbidden as a rule for the physical moduli) and they are formed for the plane waves only.

The second comment is associated with wave energy. For the adopted here model, the electric energy does not dissipate and all the waves are propagating without distortions.

Also the coefficient of electromechanical (piezoelectric) coupling K should be commented. It is linking the phase velocity of piezoelastic wave with the phase velocity of corresponding elastic wave and is introducing for different waves by different formula. But the structure of the formula is similar for all the waves.

Further reading

1. Balakirev, MK & Gilinsky, IA 1982, *Waves in piezocrystals*, Nauka, Novosibirsk. (In Russian)
2. Dieulesaint, E & Royer, D 1974, *Ondes elastiques dans les solides. Application au traitement du signal*. Masson et Cie, Paris. (In French)
3. Grinchenko, VT, Ulitko, AF & Shulga, NA 1989, *Electroelasticity*. Vol.5. Edition in 5 volumes. Mechanics of Couples Fields in Structural Members, Naukova Dumka, Kiev. (In Russian)
4. Maugin, GA 1988, *Continuum Mechanics of Electromagnetic Solids*, North-Holland, Amsterdam.

5. Tiersten, HF 1969, *Linear Piezoelectric Plate Vibrations*, Plenum Press, New York.
6. Tiersten, HF 1984, *Electric Fields, Deformable Semiconductors and Piezoelectric Devices*. In: *The Mechanical Behavior of Electromagnetic Solid Continua*. Maugin, GA (ed), North-Holland, Amsterdam.

Questions

- 18.1. Remember the definition of the wave modes. Can be called the set of three plane waves – quasilongitudinal and two transverse – the modes?
- 18.2. Compare the amplitudes of piezoelastic plane waves u_k^o and the amplitude of electric waves φ^o and comment results.
- 18.3. Comment the difference between coefficients of piezoelectric coupling for different types of plane waves on examples 1 - 3.
- 18.4. Because the example 1 corresponds to the real isotropic material, let try to generalize results on the case of arbitrary isotropic materials.
- 18.5. Let the waves are studied in the orthotropic material with orthotropy axes coinciding with coordinates axes. Can be expressed the characteristics of plane waves propagating in arbitrary direction through characteristics of plane waves propagating in coordinate axes directions?
- 18.6. Comment the small deviation of maximal values of phase velocities of piezoelastic waves from the corresponding values of phase velocities of elastic waves.

Please click the advert





it's an **interesting** world

Get under the skin of it.

Graduate opportunities
Cheltenham | £24,945 + benefits

One of the UK's intelligence services, GCHQ's role is two-fold: to gather and analyse intelligence which helps shape Britain's response to global events, and, to provide technical advice for the protection of Government communication and information systems. In doing so, our specialists – in IT, internet, engineering, languages, information assurance, mathematics and intelligence – get well beneath the surface of global affairs. If you thought the world was an interesting place, you really ought to explore our world of work.

www.careersinbritishintelligence.co.uk

Applicants must be British citizens. GCHQ values diversity and welcomes applicants from all sections of the community. We want our workforce to reflect the diversity of our work.







19 Piezoelastic waves in piezopowders

Piezocrystals, piezoceramics, piezopowders. Basic structural model of piezoelastic mixtures. Linear wave equations. Plane piezoelastic waves. Main features on an example of the plane waves.

This chapter-lecture will focus on the structural model of piezoelastic mixtures and the harmonic wave propagation in piezopowders. Two novelties will be included into the theory of piezoelectricity – the presence of internal structure in piezomaterials and discussion of special kind of piezomaterials - **piezopowders**.

Remember what is meant, when **the structural model** is introduced and the term **internal structure** is used.

Definition 19.1. The **structural model** can be any continuum model, which describes the internal structure of material and differs from the classical model of averaged moduli.

Definition 19.2. The **internal structure** reflects the fact that all the materials are composed of some components (phases) with distinguishing physical properties, geometrical shapes and known arrangement of components in the piece of material (body). Knowledge of three mentioned groups defines knowledge the internal structure.

In the book, materials are modeled within the framework of continuum mechanics; therefore firstly the material with internal structure should be described in mechanics as the inhomogeneous continuum. Further the inhomogeneous material can be analyzed in mechanics by two ways.

The first way is associated with theories of inhomogeneous media or theories of piece-wise homogeneous media. This way is out the topic of present book.

The second way is based on averaging procedures which have the goal to transform the inhomogeneous medium into the homogeneous one. The classical model of elastic medium and the corresponding classical theory of elasticity are the simplest representative of this way. But many other models – structural models – exist, which also use the averaging procedure, but take into account the presence of internal structure in the fuller manner.

Consider here the structural model of piezoelastic mixtures. And first draw the attention to three kinds of piezomaterials – **piezocrystals, piezoceramics, piezopowders**.

The piezoelectric phenomena were initially associated with crystals. Such materials are satisfactory characterized by the structure of a single crystal.

The question of the internal structure does not arise here and the classical model is therefore soundly used.

Piezoceramics is manufactured as synthesis of some initial components (oxides, nitrides, carbides, sulfides, salts and hydroxides of metals) in the form of very small granules (a few microns in diameter) using procedure of fritting. For example, for manufacturing the ceramics of Barium titanate $BaTiO_3$ the initial components TiO_2 and $BaCO_3$, and for manufacturing the ceramics $(Ba_{0.15}Sr_{0.15})TiO_3$ the initial components TiO_2 , $BaCO_3$, $SrCO_3$ are used.

The appearance of piezoceramics as the second generation of piezomaterials and the study of waves in these materials could have touched upon the questions of microstructure and drawn attention to the microstructure. But the assumptions concerning the mechanical uniformity (homogeneity) of characteristic volume of ceramics and the domain structure of polarization were found, however, to be sufficient.

Again, knowledge of the microstructure was not necessary.

Only studying and applying the granulated piezoelectric powders have forced to take into account the microstructure of these materials.

Let us point out the basis features of piezopowders:

Feature 1. Technologies of piezopowders manufacturing are used in the engineering practice. Components are lot-produced.

Feature 2. Internal structure of piezopowders is forecasted and described.

Feature 3. Granules are chosen according to their sizes and shapes, and they form the basis for the powder manufacturing.

Feature 4. The piezopowders as piezomaterials of the third generation are characterized by presence of two types of granules – granules of some ceramic piezoelectric material and lead or paraffin granules.

Note 19.1. It is necessary to remark that the layered materials “ceramics – lead” were used in piezodevices for delaying some signals. Piezopowders as granular materials were designed similarly with layered ones and they were used for the formation of delayed signals.

So, the real granular piezopowders will be later modeled by **the structural linear model of piezo-elastic mixtures**. This model unite two considered in prior chapters models – the model of homogeneous piezoelastic medium and the linear model of elastic two-component mixture.

Let us formulate the main assumption of the model.

Assumption 1. The representative volume should contain the having differing mechanical and piezoelectric properties of particles-granules of both components of the mixture; the sufficiently large number of particles of both components should be presented in the volume.

The second assumption is also characteristic of mixtures and is never used in classical models.

Assumption 2. The separate component is characterized by its own set of physical (thermodynamical) parameters:

vector of displacements $\vec{u}^{(\alpha)} = \{u_k^{(\alpha)}\}$; linear tensor of mechanical strains $\mathcal{E}^{(\alpha)} = \{\mathcal{E}_{ik}^{(\alpha)}\}$;

tensor of mechanical stresses $\sigma^{(\alpha)} = \{\sigma_{ik}^{(\alpha)}\}$; vector of electric induction $\vec{D}^{(\alpha)} = \{D_k^{(\alpha)}\}$;

vector of electric field intensity $\vec{E}^{(\alpha)} = \{E_k^{(\alpha)}\}$.

Note 19.2. In this chapter, the Greek indexes are associated with the mixture component and possess the values (1;2) and the Latin indexes are standard for all the vectors and tensors and possess the values (1;2;3).

By the general procedure of continuum mechanics, the independent thermodynamical parameters should be chosen and then the ordered pairs of parameters have to be formed. As a rule, the kinematical ones are assumed as the independent. This is formulated as the next assumption.

Assumption 3. Two ordered pairs $(\sigma_{mn}^{(\alpha)}, \mathcal{E}_{ik}^{(\alpha)})$, $(E_n^{(\alpha)}, D_k^{(\alpha)})$ correspond to each mixture component; for these pairs later the dependences will be established in the form of linear constitutive equations.

Next assumption defines the interaction between the mixture components.

Assumption 4. The interaction between the mixture components is linear and two mechanisms of interaction are taken into account – the shear force mechanism $F_i = \beta_i(u_i^{(1)} - u_i^{(2)})$ and the linear cross dependence in constitutive equations.

On the next step the constitutive equations have to be formulated. But first the polarization in the mixture should be defined and the link between polarization and the electric field intensity should be written. Thus **the polarization of separate mixture component** is assumed as follows

$$\vec{P}^{(\alpha)} = \chi_{\alpha\alpha}^{(p)} \vec{E}^{(\alpha)} + \chi_{\alpha\delta}^{(p)} \vec{E}^{(\delta)} \quad (\alpha + \delta = 3), \quad (19.1)$$

where $\chi_{11}^{(p)}, \chi_{22}^{(p)}, \chi_{12}^{(p)} = \chi_{21}^{(p)}$ are **coefficients of dielectric susceptibility**.

These coefficients should be determined from experiments or evaluated by special formulas. This is associated with the last assumption about the internal energy.

Assumption 5. The internal energy is written for the mixture as whole

$$\mathcal{U} = \mathcal{U}(\mathcal{E}_{ik}^{(1)}, \mathcal{E}_{ik}^{(2)}, u_i^{(1)} - u_i^{(2)}, D_m^{(1)}, D_m^{(2)}) \quad (19.2)$$

and assumed to be the quadratic form of independent parameters.

Now the basic system of equations for the structural model can be shown. It consists of 4 groups of equations:

Motion equations

$$\sigma_{ik}^{(\alpha)} + (-1)^\alpha \beta_i (u_i^{(1)} - u_i^{(2)}) = \rho_{\alpha\alpha} \ddot{u}_i^{(\alpha)}, \quad (19.3)$$

where $\beta_k, \rho_{\alpha\alpha}$ are the standard denotations of physical constants of the theory of mixtures.

Equations of forced electrostatics in dielectrics

$$\operatorname{div} \vec{D}^{(\alpha)} = 0, \quad \vec{E}^{(\alpha)} = -\operatorname{grad} \varphi^{(\alpha)} \quad (19.4)$$

(that is, the pure electromagnetic waves are absent).

Classical linear Cauchy relationships

$$\varepsilon_{ik}^{(\alpha)} = (1/2)(u_{i,k}^{(\alpha)} + u_{k,i}^{(\alpha)}). \quad (19.5)$$

Linear constitutive equations

$$\begin{aligned} \sigma_{ik}^{(\alpha)} &= c_{iklm}^{(\alpha)} \varepsilon_{lm}^{(\alpha)} + c_{iklm}^{(3)} \varepsilon_{lm}^{(\delta)} - e_{ikn}^{(\alpha)} E_n^{(\alpha)} - e_{ikn}^{(3)} E_n^{(\delta)}, \\ D_m^{(\alpha)} &= \tilde{\varepsilon}_{mn}^{(\alpha)} E_n^{(\alpha)} + \tilde{\varepsilon}_{mn}^{(3)} E_n^{(\delta)} + e_{mkn}^{(\alpha)} \varepsilon_{kn}^{(\alpha)} + e_{mkn}^{(3)} \varepsilon_{kn}^{(\delta)}. \end{aligned} \quad (19.6)$$

Please click the advert



HORIZONS UNIVERSITY

In Paris or Online

International programs taught by professors and professionals from all over the world

- BBA in Global Business
- MBA in International Management / International Marketing
- DBA in International Business / International Management
- MA in International Education
- MA in Cross-Cultural Communication
- MA in Foreign Languages

Innovative – Practical – Flexible – Affordable

Visit: www.HorizonsUniversity.org

Write: Admissions@horizonsuniversity.org

Call: 01.42.77.20.66



www.HorizonsUniversity.org

Equations (19.6) contain three groups of physical constants:

$c_{iklm}^{(n)}$ – elastic coefficients (determined for the constant electric field); they form three tensors of the fourth rank;

$e_{ikn}^{(m)}$ – piezoelectric coefficients; they form three tensors of the third rank;

$\tilde{\epsilon}_{mn}^{(n)}$ – coefficients of dielectric permeability (determined for the zero strains); they form three tensors of the second rank.

In the general case of arbitrary symmetry the two-component piezoelastic mixture is characterized by $21 \times 3 = 63$ independent elastic constants, $18 \times 3 = 54$ independent piezoelectric constants, and $9 \times 3 = 27$ independent dielectric permeabilities.

For example, in the simplest case of the mixture with the cubic symmetry $\bar{4}3m$ three sets of constants will include 9 elastic constants, 3 piezoelectric constants and 3 dielectric permeabilities. In the often considered case of the mixture with the hexagonal symmetry (the classical transversely isotropic case) $6mm$ the sets will include 15 elastic constants, 9 piezoelectric constants, and 6 dielectric permeabilities.

Note 19.3. It is observed that piezoceramics have usually the transversely isotropic kind of symmetry. The axis of symmetry coincides with the direction of the preliminary polarization field.

So, the basic system of equations (19.3)-(19.6) contains 32 equations and 32 unknown functions, respectively. It can be written in the form of three groups of equations:

Equations in the volume of piezoelastic body

$$c_{iklm}^{(\alpha)} u_{l,mk}^{(\alpha)} + c_{iklm}^{(3)} u_{l,mk}^{(\delta)} + (-1)^\alpha \beta_i (u_i^{(1)} - u_i^{(2)}) + e_{ikn}^{(\alpha)} \varphi_{,nk}^{(\alpha)} + e_{ikn}^{(3)} \varphi_{,nk}^{(\delta)} = \rho_{\alpha\alpha} \ddot{u}_i^{(\alpha)}, \quad (19.7)$$

$$\tilde{\epsilon}_{mn}^{(\alpha)} \varphi_{,nm}^{(\alpha)} + \tilde{\epsilon}_{mn}^{(3)} \varphi_{,nm}^{(\delta)} - e_{mkn}^{(\alpha)} u_{k,mn}^{(\alpha)} - e_{mkn}^{(3)} u_{k,mn}^{(\delta)} = 0. \quad (19.8)$$

Equations on the surface of piezoelastic body

$$\left(c_{iklm}^{(\alpha)} u_{l,m}^{(\alpha)} + c_{iklm}^{(3)} u_{l,m}^{(\delta)} + e_{ikn}^{(\alpha)} \varphi_{,n}^{(\alpha)} + e_{ikn}^{(3)} \varphi_{,n}^{(\delta)} \right) n_k = S_i^{(\alpha)o}, \quad (19.9)$$

$$\left(-\tilde{\epsilon}_{mn}^{(\alpha)} \varphi_{,n}^{(\alpha)} - \tilde{\epsilon}_{mn}^{(3)} \varphi_{,n}^{(\delta)} + e_{mkn}^{(\alpha)} u_{k,n}^{(\alpha)} + e_{mkn}^{(3)} u_{k,n}^{(\delta)} \right) = \omega^{(\alpha)o}, \quad (19.10)$$

where $S_i^{(\alpha)o}, \omega^{(\alpha)o}$ are components of the resultant vector of partial forces given on the body surface and the partial surface currents, respectively.

Equations for partial electric potentials beyond the piezoelastic body

$$\Delta \varphi^{(\alpha)} = 0 \quad \varphi^{(\alpha)} \rightarrow 0 \quad r \rightarrow \infty. \quad (19.11)$$

Groups (19.7)-(19.11) contain 8 equations relative to 8 unknown functions (two vectors of partial displacements $\vec{u}^{(\alpha)}$ and two partial electric potentials $\varphi^{(\alpha)}$).

Consider now **the plane harmonic waves**.

Definition 19.3. The propagating in the direction \vec{k} plane harmonic waves in the mixture are characterized by the partial displacements

$$\vec{u}^{(\alpha)}(x, t) = \vec{u}^{(\alpha)o} e^{i(\xi - \omega t)}, \quad (19.12)$$

where $\vec{u}^{(\alpha)o}$ is the arbitrary constant vector characterizing the wave amplitudes $\xi = \vec{k} \cdot \vec{r} = k_1 x_1 + k_2 x_2 + k_3 x_3$; \vec{r} is the radius-vector of the point (x_1, x_2, x_3) .

Note 19.4. The definition of the plane harmonic wave in the mixture (19.12) is not sufficient. It should be assumed additionally that the partial electric potentials are changing by the same law as the partial mechanical displacements

$$\varphi^{(\alpha)}(x, t) = \varphi^{(\alpha)o} e^{i(\xi - \omega t)}. \quad (19.13)$$

Substituting (19.12),(19.13) into equations (19.7),(19.8) gives the system of Christoffel type algebraic equations

$$\begin{aligned} & \left[c_{iklm}^{(\alpha)} n_k n_l \frac{k^2}{\omega^2} - \left(\rho_{\alpha\alpha} + \frac{\beta_i}{\omega^2} \right) \delta_{im} \right] u_m^{(\alpha)o} + \left[c_{iklm}^{(3)} n_k n_l \frac{k^2}{\omega^2} - \frac{\beta_i}{\omega^2} \delta_{im} \right] u_m^{(\delta)o} + \\ & + \frac{k^2}{\omega^2} \left(e_{mkn}^{(\alpha)} n_k n_n \varphi^{(\alpha)o} - e_{mkn}^{(3)} n_k n_n \varphi^{(\delta)o} \right) = 0, \end{aligned} \quad (19.14)$$

$$\tilde{\varepsilon}_{mn}^{(\alpha)} n_n n_m \varphi^{(\alpha)o} + \tilde{\varepsilon}_{mn}^{(3)} n_n n_m \varphi^{(\delta)o} - e_{mkn}^{(\alpha)} n_k n_m u_n^{(\alpha)o} - e_{mkn}^{(3)} n_k n_m u_n^{(\delta)o} = 0. \quad (19.15)$$

The system (19.14),(19.15) is the coupled system of 12 equations. But the structure of (19.15) is such that the general system of 12 equations can be reduced to the system of 6 equations identical with the Christoffel equations for a linear elastic mixture (accurate within the coefficients)

$$\left(\tilde{c}_{iklm}^{(\alpha)} \frac{k^2}{\omega^2} - \tilde{\rho}_{im} \right) u_m^{(\alpha)o} + \left(\tilde{c}_{iklm}^{(3)} \frac{k^2}{\omega^2} - \beta_{im} \right) u_m^{(\delta)o} = 0, \quad (19.16)$$

where $\tilde{\rho}_{im} = \left(\rho_{\alpha\alpha} + \frac{\beta_i}{\omega^2} \right) \delta_{im}$, $\beta_{im} = \frac{\beta_i}{\omega^2} \delta_{im}$ and formulas for tensors $\tilde{c}_{iklm}^{(n)}$ can be evaluated also. Because later they will not be used, they are omitted here.

Note 19.5. Three tensors of the fourth order $\widehat{c}_{iklm}^{(n)}$ do not describe now the elastic properties only, they include the constants of dielectric permeability and piezoelectric moduli. Thus the structural model of mixture saves the main property of inverse piezoelectric effect: coupling the mechanical and electric fields is manifested in the plane wave propagation in the way as if the medium is elastic, but the elastic moduli of this conditional medium are not the real elastic moduli. Owing to influence of the electric field, the elastic medium becomes as if more stiff and all the phase velocities must increase comparing with phase velocities evaluated when the electric field is absent.

Let simplify the next analysis assuming the wave propagation direction as the abscissa axis and the medium of propagation as the isotropic one. Then 8 unknown functions $\bar{u}^{(\alpha)}$, $\varphi^{(\alpha)}$ will depend on two variables (x, t) only.

Now the piezoelectric harmonic waves will be described by three linear wave equations

$$\rho_{aa} \ddot{u}_1^{(\alpha)} - (\lambda_\alpha + 2\mu_\alpha) u_{1,xx}^{(\alpha)} - (\lambda_3 + 2\mu_3) u_{1,xx}^{(\delta)} - \beta(u_1^{(\alpha)} - u_1^{(\delta)}) = 0, \quad (19.17)$$

$$\rho_{aa} \ddot{u}_2^{(\alpha)} - \mu_\alpha u_{2,xx}^{(\alpha)} - \mu_3 u_{2,xx}^{(\delta)} - \beta(u_2^{(\alpha)} - u_2^{(\delta)}) - e_\alpha \varphi_{,xx}^{(\alpha)} - e_3 \varphi_{,xx}^{(\delta)} = 0, \quad (19.18)$$

$$\rho_{aa} \ddot{u}_3^{(\alpha)} - \mu_\alpha u_{3,xx}^{(\alpha)} - \mu_3 u_{3,xx}^{(\delta)} - \beta(u_3^{(\alpha)} - u_3^{(\delta)}) = 0, \quad (19.19)$$

$$\tilde{\epsilon}_\alpha \varphi_{,xx}^{(\alpha)} + \tilde{\epsilon}_3 \varphi_{,xx}^{(\delta)} - e_\alpha u_{2,xx}^{(\alpha)} - e_3 u_{2,xx}^{(\delta)} = 0. \quad (19.20)$$

Please click the advert



Nido

Luxurious accommodation

Central zone 1 & 2 locations

Meet hundreds of international students

BOOK NOW and get a £100 voucher from voucherexpress

Nido Student Living - London

Visit www.NidoStudentLiving.com/Bookboon for more info.

+44 (0)20 3102 1060

Download free ebooks at bookboon.com

The last equation (19.20) permits to reevaluate the partial electric potentials through the partial displacements

$$\begin{aligned} \varphi_{,xx}^{(1)} = \bar{e}_{11} u_{2,xx}^{(1)} - \bar{e}_{12} u_{2,xx}^{(2)} = 0, \quad \varphi_{,xx}^{(2)} = \bar{e}_{21} u_{2,xx}^{(1)} - \bar{e}_{22} u_{2,xx}^{(2)} = 0, \\ \bar{e}_{11} = \frac{\tilde{\epsilon}_1 e_1 - \tilde{\epsilon}_3 e_3}{\tilde{\epsilon}_1 \tilde{\epsilon}_2 - (\tilde{\epsilon}_3)^2}, \quad \bar{e}_{12} = \frac{\tilde{\epsilon}_2 e_3 - \tilde{\epsilon}_3 e_2}{\tilde{\epsilon}_1 \tilde{\epsilon}_2 - (\tilde{\epsilon}_3)^2}, \quad \bar{e}_{21} = \frac{\tilde{\epsilon}_3 e_1 - \tilde{\epsilon}_1 e_3}{\tilde{\epsilon}_1 \tilde{\epsilon}_2 - (\tilde{\epsilon}_3)^2}, \quad \bar{e}_{22} = \frac{\tilde{\epsilon}_2 e_2 - \tilde{\epsilon}_3 e_3}{\tilde{\epsilon}_1 \tilde{\epsilon}_2 - (\tilde{\epsilon}_3)^2}. \end{aligned} \quad (19.21)$$

Then equations (19.18) and (19.10) can be united

$$\rho_{\alpha\alpha} \ddot{u}_2^{(\alpha)} - (\mu_\alpha + e_\alpha \bar{e}_{\alpha\alpha}) u_{2,xx}^{(\alpha)} - (\mu_3 + e_3 \bar{e}_{\alpha\delta}) u_{2,xx}^{(\delta)} - \beta (u_2^{(\alpha)} - u_2^{(\delta)}) = 0. \quad (19.22)$$

Thus, three coupled systems of wave equations (each system consists of two coupled equations) describe the plane wave propagation in isotropic materials – (19.17) for the plane longitudinal wave, (19.22) for the transverse horizontal plane wave, (19.19) for the transverse vertical plane wave.

The plane longitudinal and transverse vertical plane waves are purely elastic waves and do not react on presence of electric field (do not show the inverse piezoelectric effect). The transverse horizontal plane wave only manifests the inverse piezoelectric effect and reacts to presence of electric field.

Note 19.6. It can be seen from system of equations (19.22) that they are identical with corresponding elastic waves accurate within the elastic constants. New hypothetic elastic constants in (19.22) are obtained by strengthening (increasing their values) of shear constant of linear theory of elastic mixture $\hat{\mu}_\alpha = \mu_\alpha + e_\alpha \bar{e}_{\alpha\alpha}$, $\hat{\mu}_3 = \mu_3 + e_3 \bar{e}_{\alpha\delta}$.

The strengthening in the theory of elastic waves nearly always means some increasing of phase velocities of waves. But it is known that some piezoelectric materials (for example, crystals of Gallium arsenide) are characterized by the negative piezoelectric modulus. In this case, the material will not be stiffer – it will be softer.

Further some computer spatial plots will be shown. But firstly the necessary physical constants should be discussed and it is need then to define the structure of piezoelastic material. So, the piezoelastic powder will be considered, which is formed of two phases – **the first phase is made of a piezoelastic material (crystal or ceramics) and the second phase of not piezoactive material (in this case, the lead).**

The mixture of granules of two sorts is slightly pressed, and in such a way the powder becomes the material. The lead fills voids between granules of crystals or ceramics. As a result, composite granular material is formed.

Such a microstructure is classical one - granules of piezoelastic material in the matrix - lead. Therefore the obtained before in the composite materials theory formulas can be used for calculation of physical constants of the mixture-powder.

Some feature of the powders-mixtures consists in that piezo-elastic phase-component is not quite or is not at all isotropic. So, the powder will conserve this symmetry, since another phase - lead is isotropic, and it does not complicate the symmetry.

Next plots will correspond to the powder fabricated of the Gallium arsenide granules as fillers and lead as the matrix.

The granules of *GaAs* as a representative of piezocrystals belong to cubic system of the $\bar{4}3m$ class and have next physical properties:

density $\rho = 5.307 \cdot 10^3 \text{ kg/m}^3$; elastic constants $c_{11} = 118.8 \text{ MPa}$, $c_{12} = 53.8 \text{ MPa}$, $c_{44} = 59.4 \text{ MPa}$;

piezoelectric modulus $e_4 = -0.16 \text{ C/m}^2$; dielectric permeability $\tilde{\epsilon} = 0.973 \text{ nF/m}$.

The second phase-component is lead (isotropic elastic material) with next physical properties:

density $\rho = 11.23 \cdot 10^3 \text{ kg/m}^3$;

elastic constants $c_{11} = 5.2 \text{ MPa}$, $c_{12} = 3.7 \text{ MPa}$, $c_{44} = 0.75 \text{ MPa}$.

The volume fraction of the fillers was assumed to be changed in the range 0.1 – 0.5.

Dispersion curves as the main characteristics of piezoelastic plane wave propagation process show that they are qualitative identical with the corresponding elastic plane wave propagation process:

1. The piezoelastic plane wave is split into two modes both dispersive.
2. The second mode is always faster one and it is cut off for low frequencies.
3. The first mode is dispersive in the area around the cut off frequency.
4. The strong dispersion is observed for the second mode in the area to the right side from the cut off frequency.
5. The energy of initial harmonic signal is distributed among four waves – two modes in the fillers and two modes in the lead.

On next plots the horizontal transverse plane wave is considered. The formulas for evaluation of dispersion curves “phase velocity – frequency” are as follows

$$\left[\frac{1}{\left(v_{ph}^{(2)piezo\pm} \right)^2} \right] = \frac{\rho_{11}\rho_{22}}{\tilde{\mu}_1\tilde{\mu}_2 - (\tilde{\mu}_1)} \left\{ \left(\frac{\tilde{\mu}_1}{\rho_{11}} + \frac{\tilde{\mu}_2}{\rho_{22}} \right) - \frac{\tilde{\mu}_1 + \tilde{\mu}_2 + 2\tilde{\mu}_3}{\rho_{11}\rho_{22}} \frac{\beta}{\omega^2} \right\} \pm \left[\left(\left(\frac{\tilde{\mu}_1}{\rho_{11}} + \frac{\tilde{\mu}_2}{\rho_{22}} \right) - \frac{\tilde{\mu}_1 + \tilde{\mu}_2 + 2\tilde{\mu}_3}{\rho_{11}\rho_{22}} \frac{\beta}{\omega^2} \right) - \frac{\tilde{\mu}_1\tilde{\mu}_2 - (\tilde{\mu}_1)}{\rho_{11}\rho_{22}} \left(1 - \frac{\rho_{11} + \rho_{22}}{\rho_{11}\rho_{22}} \frac{\beta}{\omega^2} \right) \right]^{1/2} \right\} \quad (19.23)$$

The dispersion curves on Fig.19.1 correspond to the first slow mode (the first picture) and the second fast mode (the second picture); the third picture unites both modes. The unit on abscissa axis corresponds to frequency 100 kHz, the unit on ordinate axis corresponds to the phase velocity in 1 km/s.

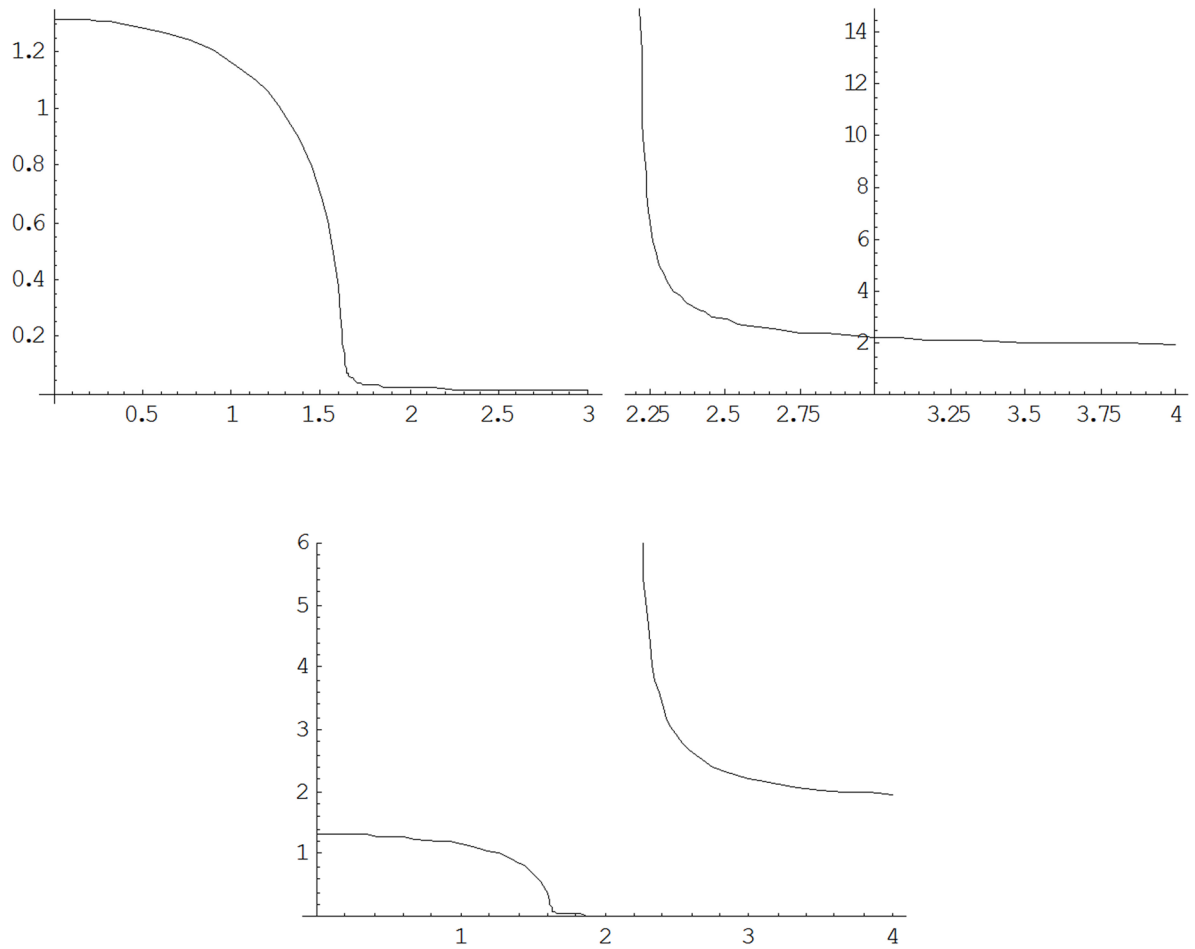

Fig.19.1. The dispersion curves for the first mode of transverse plane piezoelastic wave propagation (volume fraction of lead 0.9).

On next plots the first mode is shown for five values of volume fraction of fillers 0.1; 0.2; 0.3; 0.4; 0.5. The abscissa axis corresponds to the propagated by the wave distance in cm , the ordinate axis – to time of wave propagation in μs , the applicate axis – the wave amplitude in mm .

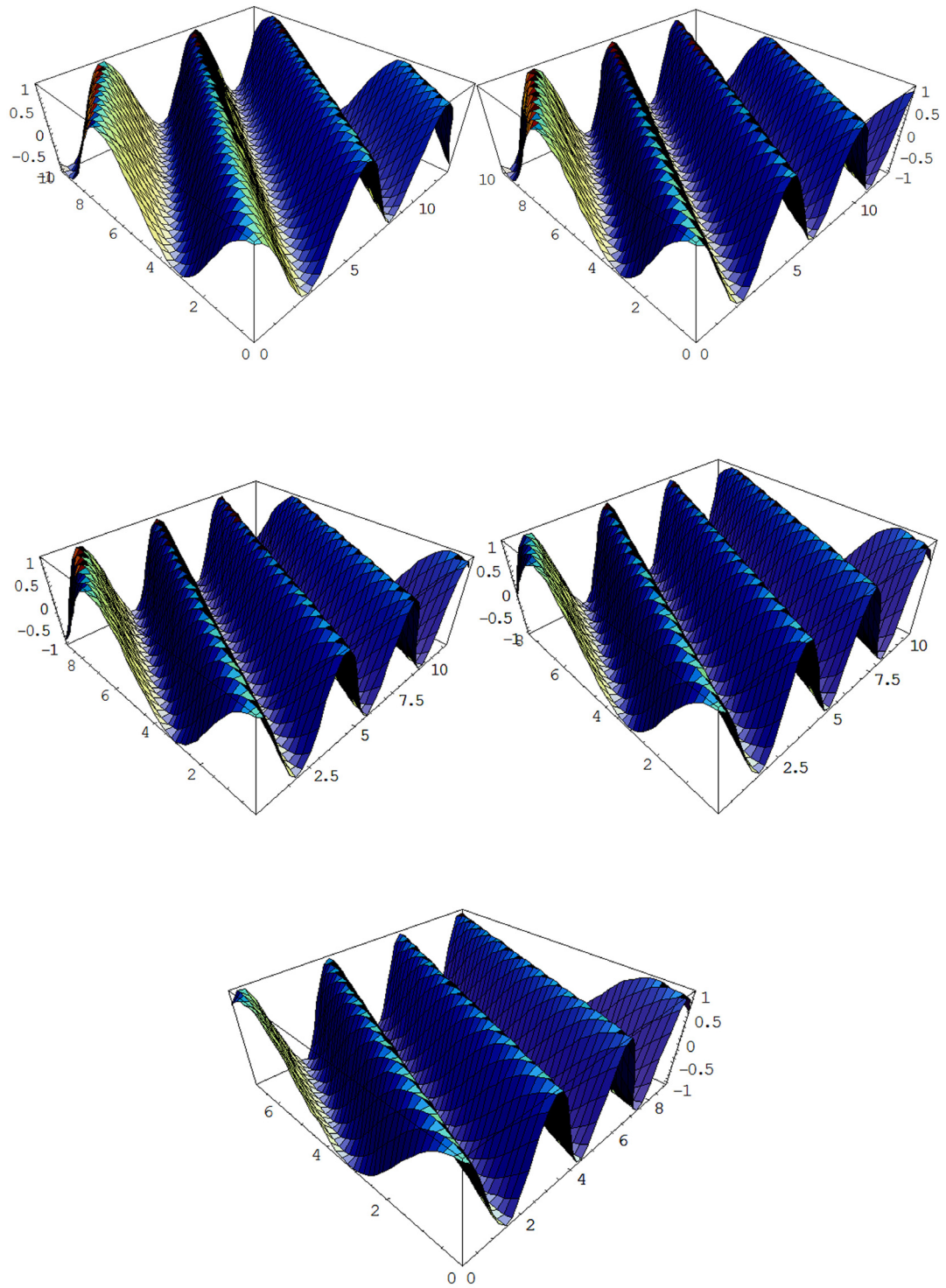

Fig.19.2. The transverse plane piezoelastic wave propagation for five case of volume fractions of lead.

As it can be seen from the pictures, the distinction of plots for different volume fractions is quite significant – when the volume fraction being changed from the very small to the almost limit case, the plot is rotated relative the coordinate axes on the not small angle (on these pictures it is about 30°).

So, by the change of volume fraction of lead the parameters of wave motion can be changed very essentially. The phase velocities of both modes are changed in the way that to more lead is added into the powder, to less the harmonic signal is propagated through this powder. It is necessary to note that this property of piezopowders is the basic one in many applications.

Comments

The specificity of piezomaterials consists in that they display the great number of physical properties symmetries. This phenomenon is characteristic for piezoactive material, and it was never before characteristic of traditional materials. But at present time, piezopowders united these two different groups of materials - they are classical granular composite materials and classical piezomaterials simultaneously.

Let us remember also that the linear piezoelastic one-continuum medium is characterized by 21 independent elastic constants, 18 independent piezoelectric constants, and 6 independent dielectric permeabilities. For piezoelastic two-phase mixtures, these constants become three times more.

Please click the advert

UNIVERSITY OF COPENHAGEN



Copenhagen Master of Excellence

Copenhagen Master of Excellence are two-year master degrees taught in English at one of Europe's leading universities

Come to Copenhagen - *and aspire!*

Apply now at
www.come.ku.dk

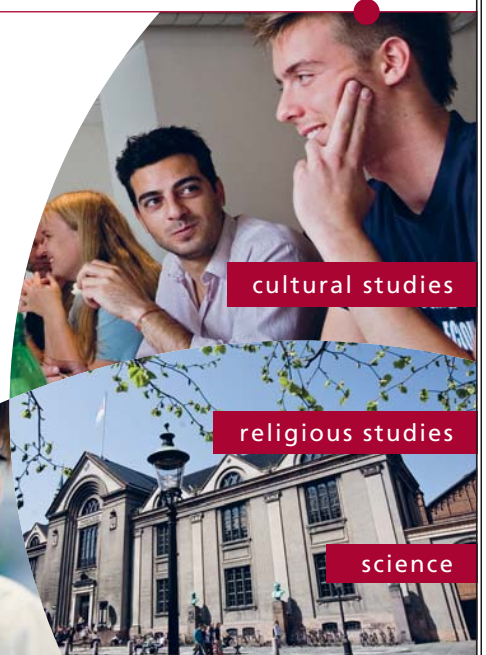

cultural studies

religious studies

science

Download free ebooks at bookboon.com

Next comment is more particular: in the theory of piezoelastic two-component mixtures in contrast to one-component continuum theories many new coefficients appear, which characterize the electromechanical interaction in the material (in the real piezopowders). For example, the wave equations for horizontal transverse plane waves (19.22) contain three blocks of constants. But the elastic mixture is the dispersive medium, for which the phase velocities depend nonlinearly on frequency and they are determined in essentially more complicate way than in the classical theory of elasticity. For example, the phase velocities for two modes of the horizontal transverse plane waves should be evaluated by the formulas.

In this case the introduction of the coefficient of electromechanical (piezoelectric) coupling K seems to be impossible and unpractical.

Further reading

1. Kessel, AP, Zeldovich, SA & Gurevich, IL 1976, 'Theory of electroacoustic echoes in piezoelectric powders', *Phys. Tverd. Tela*, vol. 18, no. 3, pp. 826-831.
2. Krainik, NN, Lemanov, VV, Popov, SN & Smolensky, GA 1975, 'Phonon echoes in crystalline powders', *Phys. Tverd. Tela*, vol. 17, no. 9, pp. 2462-2464.
3. Lightman, BT 1976, 'To the theory of two-impulse electroacoustic echoes in powders', *Phys. Tverd. Tela*, vol. 18, no. 2, pp. 612-614.
4. Maugin, GA & Eringen, AC 1977, 'On the equations of the electrodynamics of deformable bodies of finite extent', *J. de Mécanique*, vol. 16, no. 1, pp. 101-147.
5. Maugin, GA 1979, 'A continuum approach to magnon-phonon couplings. – I, II', *Int. J. Engng. Sci.*, vol. 17, no. 11, pp. 1073-1091, 1093-1108.
6. Pouget, J 1984, 'Electro-acoustic echoes in piezoelectric powders.' In: The Mechanical Behaviour of Electromagnetic Solid Continuum. Vaugin, GA (ed) *Proceedings of the IUTAM-IUPAP Symposium*, Paris, 1983. North-Holland, Amsterdam, P.177-184.
7. Rushchitsky, JJ & Khotenko, IN 1995, 'Linear waves in two-phase piezoelectrics', *Dop. NAN Ukrainy*, no. 3, pp. 41- 43. (In Ukrainian)
8. Rushchitsky, JJ & Khotenko, IN 1998, 'On nonlinear waves in two-phase piezoelectric powders', *Int. Appl. Mech.*, vol. 34, no. 8, pp. 746-754.
9. Rushchitsky, JJ, Savelieva, KV & Khotenko IN 2002, 'Plane shear waves in piezopowders: unexpected new phenomenon - the third harmonics generation', *Book of abstracts XXXth Intern. Summer School 'Advanced Problems in Mechanics'*, St. Petersburg, Russia, June 2002. - pp. 84.

Questions

- 19.1. Find some information on paraffin-based piezopowders and comment their application.
- 19.2. Build the dispersion curves like the shown on Fig.19.1 for cases of filler volume fraction 0.3 and 0.5. Compare and comment curves.
- 19.3. Build the spatial picture like shown on Fig. 19.2 for the case of filler volume fraction 0.15. Compare with cases 0.1 and 0.2. Comment this comparison.
- 19.4. Evaluate the cut off frequency for the second mode by the formula $\omega_{cut} = \sqrt{\frac{\rho_{11} + \rho_{22}}{\rho_{11}\rho_{22}}} \beta$ for five cases of filler volume fraction 0.1; 0.2; 0.3; 0.4; 0.5 and comment results.
- 19.5. Basing on results from 19.4, comment the drift of the cut off frequency in direction of higher frequencies.
- 19.6. Basing on the features of electromagnetic waves in the continuum, comment why the piezoelastic horizontal plane wave only is piezoactive.

Please click the advert

**THE BEST MASTER
IN THE NETHERLANDS**

Master of Science in Management

Kickstart your career. Start your MSc in Management in September, graduate within 16 months and join 15,000 alumni from more than 80 countries.

Are you ready to take the challenge? Register for our MSc in Management Challenge and compete to win 1 of 3 partial-tuition revolving scholarships worth €10,000!

www.nyenrode.nl/msc

NYENRODE
BUSINESS UNIVERSITEIT
A REWARD FOR LIFE

BEST MASTERS
KEUZEGIDS MASTERS 2012 *

*Keuzegids Higher Education Masters 2012, in the category of business administration

Download free ebooks at bookboon.com

20 Magnetoelastic waves

Basic model. Cases of real and perfect conductivity. Coupled systems of equations. Main features on an example of the plane magnetoelastic waves

The theory of magnetoelasticity describes the coupling of electromagnetic field and strain field, when a material is subjected to the electromagnetic field and then is deformed, as a result of which the electromagnetic field is changing and the strain field is arising.

Let us remember the classification of materials by the attribute of their interaction with an electromagnetic field (see chapter 17).

If ability to conduct the current is chosen as criterion, then all the materials can be divided on three groups:

Group 1. Materials with the resistance $< 10^{-5} \Omega \cdot m$ (the conductors).

Group 2. Materials with resistance $> 10^7 \Omega \cdot m$ (the dielectrics).

Group 3. Materials with the resistance $10^{-6} \div 10^9 \Omega \cdot m$ (the semiconductors).

The chapter is devoted to the theory of magnetoelasticity, therefore the attention is drawn to the group 1 – the conductors.

Note 20.1. The prior three chapters (chapters 17-19) were devoted to piezoelectric materials, which are relating to dielectrics (group 2). The magnetoelastic materials belong to conductors and represent therefore the somewhat different group of materials and will need new models.

The deformation of elastic conducting materials in presence of the magnetic field is described by two systems of equations: **equations of the theory of elasticity and equations of electrodynamics**, which are coupled by additional terms in both systems and by the boundary conditions.

Note 20.2. If coupling by new terms in the basic equations is standard for many theories of coupled fields, then the coupling by the nonlinear boundary conditions is specific for the magneto-elasticity.

The basic thermodynamic parameters in the classical model of magnetoelasticity are the sum of the classical parameters from the theories of elasticity and electrodynamics.

The first two parameters are the parameters of the classical elastic medium –

the Kirchhoff stress tensor t_{ik} , the Green strain tensor ε_{ik} .

They form the ordered pair of parameters and both are the second order tensors. As usually, the fields of stresses and strains assume existence of the displacement vector $\vec{u} = \{u_k\}$ field.

The set of basic parameters in electrodynamics includes four vectors –

$$\begin{aligned} &\text{the vector of electric field intensity } \vec{E} = \{E_n\}, \\ &\text{the vector of magnetic field intensity } \vec{H} = \{H_n\}, \\ &\text{the vector of electric induction } \vec{D} = \{D_n\}, \\ &\text{the vector of magnetic induction } \vec{B} = \{B_n\}. \end{aligned}$$

Restrict next analysis to anisotropic materials with linear constitutive equations both elastic and electrodynamic nature.

Notet 20.3. If a material is polarizing and magnetizable, then two vectors are additionally introducing - the vector of electric polarization $\vec{P} = \{P_n\}$ and the vector of magnetization $\vec{M} = \{M_n\}$. In next considerations these vectors will be neglected.

The motion equations of classical theory of elasticity are supplemented by two new terms and get the form

$$\sigma_{ik,k} + F_i + f_i = \rho \frac{\partial^2 u_i}{\partial t^2} \rightarrow \sigma_{ik,k} + F_i + \rho_e E_i + \epsilon_{imn} j_m B_n = \rho \frac{\partial^2 u_i}{\partial t^2}, \quad (20.1)$$

where action of electromagnetic field on mechanical field of strains is described by the Lorentz force $\vec{f} = \{f_n\}$

$$\vec{f} = \rho_e \vec{E} + \vec{j} \times \vec{B}, \quad (20.2)$$

the Levi-Civita tensor ϵ_{ijk} and current density vector $\vec{j} = \{j_m\}$ are used.

Note 20.4. Such simplified model of magnetoelastic deformation, when coupling of mechanical and electromagnetic fields is described by the Lorentz force, is historically first one. It was developed by many scientists. The model has been arisen in geophysics; the first publication (Knopoff, L 1955) considered an influence of the Earth magnetic field on elastic wave propagation in the earth stratum. It was shown thus that the magnetic field of no high level produces the small effect on the elastic wave characteristics.

As a rule, when the waves being studied, the mass forces \vec{F} are neglecting $F_i = 0$.

The constitutive equations and Cauchy relationships are no changing

$$\sigma_k = c_{iklm} \epsilon_{lm}, \quad \epsilon_{ik} = \frac{1}{2} (u_{i,k} + u_{k,i}). \quad (20.3)$$

Next group of equations is associated with the electrodynamics. It includes four basic systems

$$-\epsilon_{ikm} \frac{\partial H_m}{\partial x_k} = j_i + \frac{\partial D_i}{\partial t}, \quad \epsilon_{ikm} \frac{\partial E_m}{\partial x_k} = \frac{\partial B_i}{\partial t}, \quad (20.4)$$

$$\frac{\partial D_k}{\partial x_k} = 0, \quad \frac{\partial B_k}{\partial x_k} = 0 \quad (20.5)$$

and three types of constitutive equations

$$B_i = \mu_{ik} H_k, \quad D_i = \epsilon_{ik} E_k, \quad (20.6)$$

$$j_i = \lambda_{ik} \left(E_k + \epsilon_{ikm} B_m \frac{\partial u_k}{\partial t} \right) + \rho_e \frac{\partial u_i}{\partial t}. \quad (20.7)$$

The equation (20.7) represents the Ohm law, in which new terms arose. They reflect an influence of velocity of the moving in magnetic field particles on the density of electric current.

Note 20.5. The characteristic of magnetoelasticity terms can be commented. The term $\epsilon_{imn} j_m B_n$ in (20.1) describes an influence of ponderomotive forces, which reflect the interaction of electric currents with the magnetic field. The term $\epsilon_{ikm} B_m (\partial u_k / \partial t)$ in (20.7) corresponds to the electromotive force arising, when the electroconducting material being deformed in the magnetic field. The term $\rho_e (\partial u_i / \partial t)$ takes into account the convection currents.

Usually the stress and strain tensors $\sigma_{ik}, \epsilon_{mn}$ as well as the tensor of magnetic permeability $\hat{\mu}_{pq}$ are symmetric ones. The tensors of the dielectric permeability ϵ_{mn} and the conductivity $\hat{\lambda}_{ik}$ can be asymmetric.

The main wave effects will be saved when **to assume the free electric charges and offset current to be zero** $\rho_e = 0$, $D_m = 0$.

The system (20.1),(20.3)-(20.7) is the basic one for the theory of magnetoelasticity. But sometimes **the Maxwell stress tensor** T_{ik} is introduced into this system

$$T_{ik} = E_i D_k + H_i B_k - (1/2)(E_m D_m + H_m B_m) \delta_{ik}, \quad (20.8)$$

or for the case of the offset current absence $D_m = 0$

$$T_{ik} = H_i B_k - (1/2) H_m B_m \delta_{ik}. \quad (20.9)$$

Then the system (20.1) with allowance for (20.9) is changed to

$$(\sigma_{ik} + T_{ik})_{,k} + F_i = \rho \frac{\partial^2 u_i}{\partial t^2}, \quad (20.10)$$

and the boundary condition of absence of the stresses are very like to the classical ones

$$(\sigma_{ik} + T_{ik})n_k = 0. \quad (20.11)$$

In the case $F_i = 0$, $\rho_e = 0$, $D_m = 0$ the system (20.1),(20.3)-(20.7) is simplified and the isotropic magnetoelastic materials are governed by next equations

$$\rho_o \ddot{\vec{u}} = \mu \nabla^2 \vec{u} + (\lambda + \mu) \nabla (\nabla \cdot \vec{u}) + \hat{\mu} \vec{j} \times \vec{H}, \quad (20.12)$$

$$\nabla \times \vec{H} = \vec{j}, \quad \nabla \times \vec{E} = -\hat{\mu} \dot{\vec{H}}, \quad \nabla \cdot \vec{H} = 0, \quad \vec{j} = \hat{\lambda} (E + \dot{\vec{u}} \times \vec{H}),$$

$$\dot{\vec{H}} = -\nabla \times \nabla \times \vec{H} + \nabla \times (\dot{\vec{u}} \times \vec{H}),$$

where **six physical constants only are used:**

the density of material ρ_o , two Lamé elastic constants λ, μ , the magnetic permeability $\hat{\mu}$, the dielectric permeability ϵ , the conductivity $\hat{\lambda}$.

Usually the linearization of nonlinear relationships in magnetoelasticity is carried out. First, the restriction on the magnetic field is adopted: the initial magnetic field is strong and constant $\vec{H}^o = const$. Let the magnetoelastic body starts to move at $t = 0$. Then next assumption is taken on: the motion of the body will be described by small fluctuations in values and directions of electric and magnetic fields $\vec{e}(x, t), \vec{h}(x, t)$ ($x \equiv (x_1, x_2, x_3)$), respectively

$$\vec{E}(x, t) = \vec{e}(x, t), \quad \vec{H}(x, t) = \vec{H}^o + \vec{h}(x, t). \quad (20.13)$$

Then the basic system of magnetoelasticity is reducing to **two coupled vector equations (six coupled scalar equations)**

$$\rho_o \ddot{\vec{u}} = \mu \Delta \vec{u} + (\lambda + \mu) \text{gr} \text{div} \vec{u} + \hat{\mu} (\text{rot} \vec{h} \times \vec{H}^o - \hat{\epsilon} \vec{e} \times \vec{H}^o - \hat{\epsilon} \ddot{\vec{u}} \times \vec{H}^o \times \vec{H}^o), \quad (20.14)$$

$$\Delta \vec{h} - \beta \dot{\vec{h}} - \beta_o \ddot{\vec{h}} = -\beta \text{rot} (\dot{\vec{u}} \times \vec{H}^o) - \alpha \text{rot} (\ddot{\vec{u}} \times \vec{H}^o), \quad (20.15)$$

$$\alpha = \hat{\epsilon} \hat{\mu} - \hat{\epsilon}_o \hat{\mu}_o, \quad \beta = \hat{\lambda} \hat{\mu}, \quad \beta_o = \hat{\epsilon} \hat{\mu},$$

where $\hat{\epsilon}_o, \hat{\mu}_o$ are **the electric permeability and magnetic permeability**, in vacuum, respectively.

It is well-known that the electromagnetic waves are faster significantly the mechanical waves, what means that frequencies of electromagnetic waves are essentially more than those of mechanical waves for the fixed wave length of mechanical wave. Therefore the electromagnetic field can be treated as the quasi-static one, when the mechanical waves being studied. In this case, the system (20.14),(20.15) is simplified

$$\rho_o \ddot{\vec{u}} = \mu \Delta \vec{u} + (\lambda + \mu) \text{gr} \text{div} \vec{u} + \hat{\mu} \text{rot} \vec{h} \times \vec{H}^o, \quad (20.16)$$

$$\Delta \vec{h} - \beta \dot{\vec{h}} = -\beta \operatorname{rot}(\dot{\vec{u}} \times \vec{H}^o). \quad (20.17)$$

Note 20.6. The system (20.16),(20.17) is still coupled.

Solving this system gives two vector functions – the displacement \vec{u} and the magnetic field intensity \vec{h} . The electric field intensity \vec{e} , the electric current density \vec{j} , and the magnetic induction \vec{B} can be determined from the simplified Maxwell equations

$$\operatorname{rot} \vec{h} = \vec{j}, \operatorname{div} \vec{h} = 0, \operatorname{rot} \vec{E} = -\hat{\mu} \dot{\vec{h}}, \vec{j} = \hat{\lambda} (\vec{e} + \hat{\mu} \dot{\vec{u}} \times \vec{H}^o), \vec{B} = \hat{\mu} (\vec{H}^o + \vec{h}). \quad (20.18)$$

Note 20.7. It follows from equation (20.18) that the coupled basic system of equations (20.16)-(20.18) is partially split. Two of five unknown fields should be determined from the coupled system and then next three fields can be determined through the first two fields.

**The system (20.16)-(20.18) describes
the magnetoelastic materials with the real conductivity.**

Destination MMU



Manchester
Metropolitan
University

MMU is proud to be one of the most popular universities in the UK. Some 34,000 students from all parts of the globe select from its curricula of over 1,000 courses and qualifications.

We are based in the dynamic yet conveniently compact city of Manchester, located at the heart of a sophisticated transport network including a major international airport on the outskirts. Parts of the campus are acclaimed for their architectural style and date back over 150 years, in direct contrast to our teaching style which is thoroughly modern, innovative and forward-thinking.

MMU offers undergraduate and postgraduate courses in the following subject areas:

- Art, Design & Performance
- Computing, Engineering & Technology
- Business & Management
- Science, Environmental Studies & Geography
- Law, Education & Psychology
- Food, Hospitality, Tourism & Leisure Studies
- Humanities & Social Science

For more details or an application form please contact MMU International.
email: international@mmu.ac.uk
telephone: +44 (0)161 247 1022
www.mmu.ac.uk/international

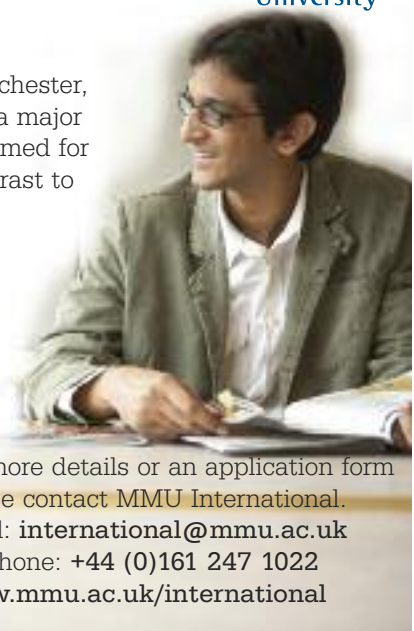

Please click the advert

Consider now **the case of perfect conductivity**, which is characterized by the value of conductivity $\hat{\lambda} = \infty$ and hence $\beta = \infty$. Then equations (20.17),(20.18) are simplified

$$\vec{h} = \text{rot}(\vec{u} \times \vec{H}^o), \quad (20.19)$$

$$\vec{e} = -\dot{\vec{u}} \times \vec{H}^o, \quad \vec{\nabla} \cdot \vec{h} = 0. \quad (20.20)$$

Substituting (20.19) into (20.16) gives

$$\rho_o \ddot{\vec{u}} = \mu \Delta \vec{u} + (\lambda + \mu) \text{gr} \text{div} \vec{u} + \hat{\mu} \text{rot} \text{rot}(\vec{u} \times \vec{H}^o) \times \vec{H}^o. \quad (20.21)$$

Thus, system (20.19)-(20.21) is no coupled. First equation (20.21) should be solved and the displacement field \vec{u} found. Second, the magnetic field intensity \vec{h} and electric field intensity \vec{e} can be found from equations (20.19),(20.20).

Note 20.8. Two books (Nowacki, W 1984; Selezov, IT & Selezova, LV 1975) can be recommended for additional information on above and next considerations of wave propagation in magnetoelastic materials.

Consider now **one more variant of the model of perfect conductivity**, when initially the constant magnetic induction field is given instead (20.13)

$$\vec{E}(x, t) = \vec{e}(x, t), \quad \vec{B}(x, t) = \vec{B}^o + \vec{b}(x, t). \quad (20.22)$$

Then the system like to system (20.19)-(20.21) governs the magnetoelastic processes in materials

$$\rho_o \ddot{\vec{u}} = \mu \Delta \vec{u} + (\lambda + \mu) \text{gr} \text{div} \vec{u} + (1/\hat{\mu}) \text{rot} \text{rot}(\vec{u} \times \vec{B}^o) \times \vec{B}^o. \quad (20.23)$$

$$\vec{b} = \text{rot}(\vec{u} \times \vec{B}^o). \quad (20.24)$$

The case of real conductivity is some more complicate

$$\rho_o \ddot{\vec{u}} = \mu \Delta \vec{u} + (\lambda + \mu) \text{gr} \text{div} \vec{u} + (1/\hat{\mu}) \text{rot} \vec{b} \times \vec{B}^o, \quad (20.25)$$

$$\Delta \vec{b} - \beta \dot{\vec{b}} = -\beta \text{rot}(\dot{\vec{u}} \times \vec{B}^o). \quad (20.26)$$

Let us pass to **the plane waves in magnetoelastic materials** and start with the simplest case of **materials with perfect conductivity**.

Then equation (20.23),(20.24) are the basic ones. Assume the motion in direction of abscissa axis and all the fields depend on variables (x_1, t) only.

Remind that the magnetic induction $\vec{B}^o = \{B_1^o, B_2^o, B_3^o\}$ is constant and then owing to (20.24)

$$\vec{b} = \left\{ 0; \frac{\partial}{\partial x_1}(u_1 B_2^o - u_2 B_1^o); \frac{\partial}{\partial x_1}(u_3 B_1^o - u_1 B_3^o) \right\}.$$

Substitution last representation into equations (20.23) gives three wave equations

$$(\lambda + 2\mu) \frac{\partial^2 u_1}{\partial x_1^2} - \rho \frac{\partial^2 u_1}{\partial t^2} + \frac{1}{\bar{\mu}} \left[(B_2^o)^2 + (B_3^o)^2 \right] \frac{\partial^2 u_1}{\partial x_1^2} - \frac{B_1^o B_2^o}{\bar{\mu}} \frac{\partial^2 u_2}{\partial x_1^2} - \frac{B_1^o B_3^o}{\bar{\mu}} \frac{\partial^2 u_3}{\partial x_1^2} = 0, \quad (20.27)$$

$$\mu \frac{\partial^2 u_2}{\partial x_1^2} - \rho \frac{\partial^2 u_2}{\partial t^2} + \frac{(B_1^o)^2}{\bar{\mu}} \frac{\partial^2 u_2}{\partial x_1^2} - \frac{B_1^o B_2^o}{\bar{\mu}} \frac{\partial^2 u_1}{\partial x_1^2} = 0, \quad (20.28)$$

$$\mu \frac{\partial^2 u_3}{\partial x_1^2} - \rho \frac{\partial^2 u_3}{\partial t^2} + \frac{(B_1^o)^2}{\bar{\mu}} \frac{\partial^2 u_3}{\partial x_1^2} - \frac{B_1^o B_3^o}{\bar{\mu}} \frac{\partial^2 u_1}{\partial x_1^2} = 0. \quad (20.29)$$

Note 20.9. In contrast to the corresponding classical case of plane elastic waves, when one longitudinal and two transverse waves are described by independent linear equations, the magnetoelastic waves are coupled and depend nonlinearly (quadratically nonlinear) on the known constant magnetic induction field $\vec{B}^o = \{B_1^o, B_2^o, B_3^o\}$.

Assume now following to (Nowacki, W 1984) $b_3 = 0 \leftrightarrow B_3^o = 0, u_3 = 0$. This permits to use the similarity of equations (20.28) and (20.29) for transverse horizontal and vertical plane waves and to consider two waves only – longitudinal and transverse horizontal waves

$$(\lambda + 2\mu) \frac{\partial^2 u_1}{\partial x_1^2} - \rho \frac{\partial^2 u_1}{\partial t^2} + \frac{(B_2^o)^2}{\bar{\mu}} \frac{\partial^2 u_1}{\partial x_1^2} - \frac{B_1^o B_2^o}{\bar{\mu}} \frac{\partial^2 u_2}{\partial x_1^2} = 0, \quad (20.30)$$

$$\mu \frac{\partial^2 u_2}{\partial x_1^2} - \rho \frac{\partial^2 u_2}{\partial t^2} + \frac{(B_1^o)^2}{\bar{\mu}} \frac{\partial^2 u_2}{\partial x_1^2} - \frac{B_1^o B_2^o}{\bar{\mu}} \frac{\partial^2 u_1}{\partial x_1^2} = 0. \quad (20.31)$$

Assume that the plane harmonic waves with known frequency ω , unknown phase velocity v_{ph} and unknown wave number $k = (\omega/v_{ph})$ are propagating

$$u_1 = u_1^o e^{i(kx_1 - \omega t)}, \quad u_2 = u_2^o e^{i(kx_1 - \omega t)}.$$

Then the dispersion equation is as follows

$$k^4 \left(1 + \frac{(B_1^o)^2}{\rho \bar{\mu} (c_T)^2} + \frac{(B_2^o)^2}{\rho \bar{\mu} (c_L)^2} \right) - k^2 \left[\left(1 + \frac{(B_1^o)^2}{\rho \bar{\mu} (c_T)^2} \right) \frac{\omega^2}{(c_L)^2} + \left(1 + \frac{(B_2^o)^2}{\rho \bar{\mu} (c_L)^2} \right) \frac{\omega^2}{(c_T)^2} \right] + \frac{\omega^2}{(c_L)^2} \frac{\omega^2}{(c_T)^2} = 0, \quad (20.32)$$

or $k^4 M_4 - k^2 M_2 + M_0 = 0$,

where the classical denotations for velocities of elastic waves $c_L = \sqrt{\frac{\lambda + 2\mu}{\rho}}$, $c_T = \sqrt{\frac{\mu}{\rho}}$ are used.

The equation (20.32) is the algebraic biquadratic equation and describes therefore two waves with differing phase velocities propagating in two directions – to the left and to the right.

Note 20.10. Such situation of existence of two wave modes has been fixed before for elastic waves, propagation of which was described by the structural model of two-component mixture (see chapter 9).

Choose the right direction. Then system of wave equations (20.31),(20.32) has the solution

$$u_1(x_1, t) = A_{11} e^{-i\omega \left(t - \frac{x_1}{v_{ph}^{(1)}} \right)} + A_{12} e^{-i\omega \left(t - \frac{x_1}{v_{ph}^{(2)}} \right)}, \quad (20.33)$$

$$u_2(x_1, t) = A_{21} e^{-i\omega \left(t - \frac{x_1}{v_{ph}^{(1)}} \right)} + A_{22} e^{-i\omega \left(t - \frac{x_1}{v_{ph}^{(2)}} \right)}, \quad (20.34)$$

where phase velocities $v_{ph}^{(k)}$ are determined from dispersion equation (20.32)

$$\left(k^{(1;2)} \right)^2 = \frac{\omega^2}{\left(v_{ph}^{(1;2)} \right)^2} = \frac{1}{2M_4} \left(M_2 \pm \sqrt{(M_2)^2 - M_0} \right). \quad (20.35)$$

Please click the advert



Develop the tools we need for Life Science

Masters Degree in Bioinformatics

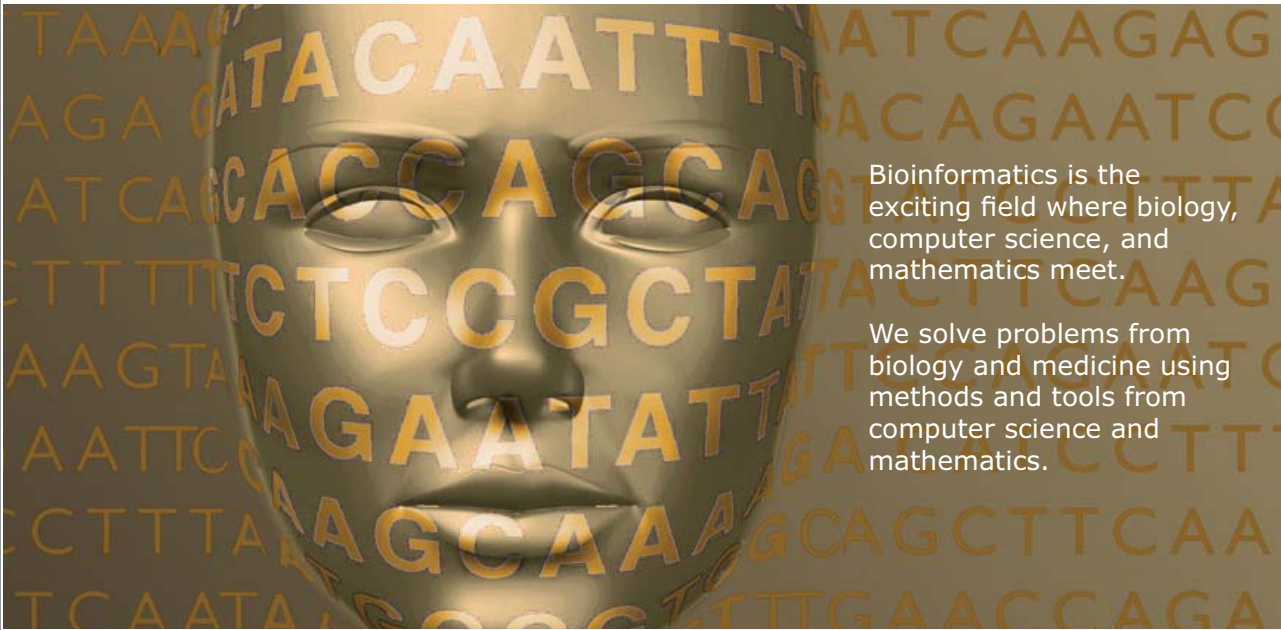

Bioinformatics is the exciting field where biology, computer science, and mathematics meet.

We solve problems from biology and medicine using methods and tools from computer science and mathematics.

Read more about this and our other international masters degree programmes at www.uu.se/master

Download free ebooks at bookboon.com

Because $M_0 \geq 0$, then roots (20.35) are positive and phase velocities take values of real numbers.

When the mechanical displacement waves are evaluated, then the electromagnetic waves with the same wave characteristics can be evaluated by the formulas

$$\vec{b} = \left\{ 0; \frac{\partial}{\partial x_1} (u_1 B_2^o - u_2 B_1^o); 0 \right\}, \quad \vec{e} = -\left\{ 0; 0; (\dot{u}_1 B_2^o - \dot{u}_2 B_1^o) \right\}, \quad \vec{j} = \left\{ 0; 0; \frac{\partial b_2}{\partial x_1} \right\}. \quad (20.36)$$

Some properties of waves can be observed right away.

1. All the waves are magnetoelastic ones in the sense that the parameters of waves (phase velocities, wave numbers, coefficients of amplitude distribution) depend nonlinearly on the values of magnetic induction.
2. All the waves are dispersive ones owing to nonlinear dependence of M_2, M_0 on frequency.
3. Two only A_{11}, A_{22} of four amplitudes A_{mn} are arbitrary, other two amplitudes are as follows $A_{21} = l_1(\omega) A_{11}$, $A_{12} = l_2(\omega) A_{22}$, and the matrix of amplitude distribution can be introduced $\begin{pmatrix} 1 & l_2 \\ l_1 & 1 \end{pmatrix}$. The matrix shows that relative values of amplitudes is changing with the frequency change.
4. All the types of waves (mechanical displacement \vec{u} , magnetic induction \vec{b} , electric field intensity \vec{e} , electric current density \vec{j}) are doubled – two waves with distinguishing phase velocities are propagating simultaneously, the fast and the slow waves.
5. Each wave does not attenuate and saves its harmonic profile over all the distance of propagation.

Consider further three simple cases of assignment of the constant magnetic induction.

Case 1. $\vec{B}^o = \{0; 0; 0\}$. It is the simplest one, because it corresponds to absence of the magnetic induction. The wave equations (20.29), (20.30) are split fully and dispersion equation (20.32)

$$\text{becomes } \left(k^2 - \frac{\omega^2}{(c_L)^2} \right) \left(k^2 - \frac{\omega^2}{(c_T)^2} \right) = 0.$$

Thus the set of different magnetoelastic waves is transformed into two only purely elastic displacement waves.

Case 2. The vector of magnetic induction involves the second component only $B^o = \{0; B_2^o; 0\}$. The wave equations (20.29), (20.30) are split fully, but (20.29) saves the dependence on B_2^o

$$(\lambda + 2\mu) \frac{\partial^2 u_1}{\partial x_1^2} - \rho \frac{\partial^2 u_1}{\partial t^2} + \frac{(B_2^o)^2}{\bar{\mu}} \frac{\partial^2 u_1}{\partial x_1^2} = 0, \quad \mu \frac{\partial^2 u_2}{\partial x_1^2} - \rho \frac{\partial^2 u_2}{\partial t^2} = 0.$$

The dispersion equation becomes as condition of solvability of the system above (the determinant of the second order is zero)

$$\left[k^2 \left(1 + \frac{(B_2^o)^2}{\rho \bar{\mu} (c_L)^2} \right) - \frac{\omega^2}{(c_L)^2} \right] \left(k^2 - \frac{\omega^2}{(c_T)^2} \right) = 0.$$

Thus the transverse displacement wave is purely elastic one.

The longitudinal displacement wave is magnetoelastic one,

it propagates with the phase velocity $v_{ph}^{(1)} = c_L \sqrt{1 + \frac{(B_2^o)^2}{\rho \hat{\mu} (c_L)^2}}$, which exceeds the phase velocity of corresponding elastic wave c_L .

The electromagnetic fields will repeat the wave motion of mechanical displacement field $\vec{u} = \{u_1, u_2, 0\}$ according to formulas (20.36).

Case 3. The vector of magnetic induction involves the first component only $B^o = \{B_1^o; 0; 0\}$.

The wave equations (20.29), (20.30) are split fully, but (20.30) saves the dependence on B_1^o

$$(\lambda + 2\mu) \frac{\partial^2 u_1}{\partial x_1^2} - \rho \frac{\partial^2 u_1}{\partial t^2} = 0, \quad \mu \frac{\partial^2 u_2}{\partial x_1^2} - \rho \frac{\partial^2 u_2}{\partial t^2} + \frac{(B_1^o)^2}{\hat{\mu}} \frac{\partial^2 u_2}{\partial x_1^2} = 0.$$

The dispersion equation becomes $\left(k^2 - \frac{\omega^2}{(c_L)^2}\right) \left[k^2 \left(1 + \frac{(B_1^o)^2}{\rho \hat{\mu} (c_T)^2}\right) - \frac{\omega^2}{(c_T)^2}\right] = 0$.

Thus the longitudinal displacement wave is purely elastic one.

The transverse displacement wave is magnetoelastic one,

it propagates with the phase velocity $v_{ph}^{(2)} = c_T \sqrt{1 + \frac{(B_1^o)^2}{\rho \hat{\mu} (c_T)^2}}$, which exceeds the phase velocity of corresponding elastic wave c_T .

The electromagnetic fields will repeat the wave motion of mechanical displacement field $\vec{u} = \{u_1, u_2, 0\}$ according to formulas (24.36).

Finally, consider **the materials with a real conductivity.**

First rewrite basic system (20.23), (20.24)

$$\rho_o \ddot{\vec{u}} = \mu \Delta \vec{u} + (\lambda + \mu) \text{grad} \text{div} \vec{u} + (1/\hat{\mu}) \text{rot} \vec{b} \times \vec{B}^o, \quad \Delta \vec{b} - \beta \dot{\vec{b}} = -\beta \text{rot}(\dot{\vec{u}} \times \vec{B}^o).$$

Assume like the case of perfect conductivity from above the motion in direction of abscissa axis and all the fields depend on variables (x_1, t) only.

Then last equations become

$$(\lambda + 2\mu) \frac{\partial^2 u_1}{\partial x_1^2} - \rho \frac{\partial^2 u_1}{\partial t^2} + \frac{1}{\hat{\mu}} \left(B_2^o \frac{\partial b_2}{\partial x_1} + B_3^o \frac{\partial b_3}{\partial x_1} \right) = 0, \quad (20.37)$$

$$\mu \frac{\partial^2 u_2}{\partial x_1^2} - \rho \frac{\partial^2 u_2}{\partial t^2} + \frac{B_1^o}{\hat{\mu}} \frac{\partial b_2}{\partial x_1} = 0, \quad (20.38)$$

$$\mu \frac{\partial^2 u_3}{\partial x_1^2} - \rho \frac{\partial^2 u_3}{\partial t^2} + \frac{B_1^o}{\hat{\mu}} \frac{\partial b_3}{\partial x_1} = 0, \quad (20.39)$$

$$\frac{\partial^2 b_1}{\partial x_1^2} - \beta \frac{\partial b_1}{\partial t} = 0, \quad (20.40)$$

$$\frac{\partial^2 b_2}{\partial x_1^2} - \beta \frac{\partial b_2}{\partial t} = \beta \left(B_2^o \frac{\partial^2 u_1}{\partial x_1 \partial t} - B_1^o \frac{\partial^2 u_2}{\partial x_1 \partial t} \right), \quad (20.41)$$

$$\frac{\partial^2 b_3}{\partial x_1^2} - \beta \frac{\partial b_3}{\partial t} = -\beta \left(B_1^o \frac{\partial^2 u_3}{\partial x_1 \partial t} - B_3^o \frac{\partial^2 u_1}{\partial x_1 \partial t} \right). \quad (20.42)$$

Let now $b_3 = 0 \leftrightarrow B_3^o = 0, u_3 = 0$.

This permits to use the similarity of equations (20.38) and (20.39) for transverse horizontal and vertical plane waves and to consider equations for longitudinal and transverse horizontal waves (20.37),(20.38). Also equation (20.41) will remain.

Assume that the plane harmonic waves with known frequency ω , unknown phase velocity v_{ph} and unknown wave number $k = (\omega/v_{ph})$ are propagated

$$u_1 = u_1^o e^{i(kx_1 - \omega t)}, u_2 = u_2^o e^{i(kx_1 - \omega t)}, b_2 = b_2^o e^{i(kx_1 - \omega t)}. \quad (20.43)$$

Please click the advert

MÄLARDALEN UNIVERSITY SWEDEN

WELCOME TO OUR WORLD OF TEACHING!
INNOVATION, FLAT HIERARCHIES AND OPEN-MINDED PROFESSORS

STUDY IN SWEDEN - HOME OF THE NOBEL PRIZE
CLOSE COLLABORATION WITH FUTURE EMPLOYERS SUCH AS ABB AND ERICSSON

TAKE THE FAST TRACK

GIVE YOUR CAREER A HEAD START AT MÄLARDALEN UNIVERSITY
www.mdh.se

SASHA SHAHBAZI
LEFT IRAN FOR A MASTERS IN PRODUCT AND PROCESS DEVELOPMENT AND LOTS OF INNEBANDY
HE'LL TELL YOU ALL ABOUT IT AND ANSWER YOUR QUESTIONS AT MDUSTUDENT.COM

Then the dispersion equation is obtaining as condition of solvability of the system (20.37),(20.38), (24.41) (the determinant of the third order is zero)

$$\left(k^2 - \frac{\omega^2}{(c_L)^2}\right) \left[\left(k^2 - \frac{\omega^2}{(c_L)^2}\right) \left(1 + \frac{ik^2}{\bar{\mu}\omega\bar{\lambda}}\right) + \frac{k^2 (B_2^o)^2}{\rho\bar{\mu}(c_L)^2} \right] + \frac{k^2 (B_1^o)^2}{\rho\bar{\mu}(c_T)^2} \left(k^2 - \frac{\omega^2}{(c_L)^2}\right) = 0 \quad (20.44)$$

or

$$k^6 \bar{M}_6 + k^4 \bar{M}_4 - k^2 \bar{M}_2 + \bar{M}_0 = 0.$$

The equation (20.44) has three complex roots $(k^{(m)})^2$, corresponding three phase velocities $v_{ph}^{(m)} = (\omega/\Re k^{(m)})$ and three attenuation coefficients $\mathcal{G}^{(m)} = \Im k^{(m)}$. The solution in the form of propagating to the right plane waves is as follows

$$u_1(x_1, t) = A_{11} e^{\mathcal{G}^{(1)} x_1} e^{-i\omega \left(t - \frac{x_1}{v_{ph}^{(1)}}\right)} + A_{12} e^{\mathcal{G}^{(2)} x_1} e^{-i\omega \left(t - \frac{x_1}{v_{ph}^{(2)}}\right)} + A_{13} e^{\mathcal{G}^{(3)} x_1} e^{-i\omega \left(t - \frac{x_1}{v_{ph}^{(3)}}\right)}, \quad (20.45)$$

$$u_2(x_1, t) = A_{21} e^{\mathcal{G}^{(1)} x_1} e^{-i\omega \left(t - \frac{x_1}{v_{ph}^{(1)}}\right)} + A_{22} e^{\mathcal{G}^{(2)} x_1} e^{-i\omega \left(t - \frac{x_1}{v_{ph}^{(2)}}\right)} + A_{23} e^{\mathcal{G}^{(3)} x_1} e^{-i\omega \left(t - \frac{x_1}{v_{ph}^{(3)}}\right)}. \quad (20.46)$$

$$b_2(x_1, t) = A_{31} e^{\mathcal{G}^{(1)} x_1} e^{-i\omega \left(t - \frac{x_1}{v_{ph}^{(1)}}\right)} + A_{32} e^{\mathcal{G}^{(2)} x_1} e^{-i\omega \left(t - \frac{x_1}{v_{ph}^{(2)}}\right)} + A_{33} e^{\mathcal{G}^{(3)} x_1} e^{-i\omega \left(t - \frac{x_1}{v_{ph}^{(3)}}\right)}. \quad (20.47)$$

Note 20.11. The wave will be attenuating one if $\mathcal{G}^{(m)} < 0$. This fact is not proven and will possible be confirmed in real evaluations.

Some properties of waves can be observed right away.

1. All the waves are magnetoelastic ones in the sense that the parameters of waves (phase velocities, wave numbers, attenuation coefficients, coefficients of amplitude distribution) depend non-linearly on the values of magnetic induction.
2. All the waves are dispersive ones owing to nonlinear dependence of $\bar{M}_4, \bar{M}_2, \bar{M}_0$ on frequency.
3. Three only A_{11}, A_{22}, A_{33} of nine amplitudes A_{mn} are arbitrary, other six amplitudes are as follows

$$A_{21} = l_{12}(\omega) A_{11}, \quad A_{31} = l_{13}(\omega) A_{11}, \quad A_{12} = l_{21}(\omega) A_{22},$$

$$A_{32} = l_{23}(\omega) A_{22}, \quad A_{13} = l_{31}(\omega) A_{33}, \quad A_{32} = l_{23}(\omega) A_{33},$$

the matrix of amplitude distribution $\begin{pmatrix} 1 & l_{21} & l_{31} \\ l_{12} & 1 & l_{32} \\ l_{13} & l_{23} & 1 \end{pmatrix}$ can be evaluated.

The matrix shows that relative values of amplitudes will change with the frequency change.

4. All the types of waves (mechanical displacement \vec{u} , magnetic induction \vec{b} , electric field intensity \vec{e} , electric current density \vec{j}) are tripled –three waves with distinguishing phase velocities are propagating simultaneously.

5. Each wave attenuates by exponential law and save its frequency over all the distance of propagation.

Consider further **three simple cases** of assignment of the constant magnetic induction.

Case 1. $\vec{B}^o = \{0; 0; 0\}$. It is the simplest one, because it corresponds to absence of the magnetic induction. Three wave equations (20.37),(20.38),(20.41) are split fully and dispersion equation (20.44) becomes

$$\left(k^2 - \frac{\omega^2}{(c_L)^2} \right) \left(k^2 - \frac{\omega^2}{(c_T)^2} \right) (ik + i\bar{\mu}\bar{\lambda}\omega) = 0.$$

Thus the set of different magnetoelastic waves is transformed into three waves: two purely elastic longitudinal and transverse displacement waves and one wave reflecting the oscillation of the electromagnetic field.

Case 2. The vector of magnetic induction involves the second component only $B^o = \{0; B_2^o; 0\}$.

The wave equations are split partially: equations (20.37) and (20.41) save coupling

$$(\lambda + 2\mu) \frac{\partial^2 u_1}{\partial x_1^2} - \rho \frac{\partial^2 u_1}{\partial t^2} + \frac{(B_2^o)^2}{\bar{\mu}} \frac{\partial^2 b_2}{\partial x_1^2} = 0, \quad \frac{\partial^2 b_2}{\partial x_1^2} - \beta \frac{\partial b_2}{\partial t} = \beta B_2^o \frac{\partial^2 u_1}{\partial x_1 \partial t},$$

but equation (20.38) degenerates into its elastic variant $\mu \frac{\partial^2 u_2}{\partial x_1^2} - \rho \frac{\partial^2 u_2}{\partial t^2} = 0$.

The dispersion equation becomes as condition of solvability of the system above

$$\left\{ \frac{k^4}{\bar{\mu}\bar{\lambda}\omega} - k^2 \left[\frac{\omega^2}{(c_L)^2} \frac{1}{\bar{\mu}\bar{\lambda}\omega} + i \left(1 + \frac{(B_2^o)^2}{\rho\bar{\mu}(c_L)^2} \right) \right] + i \frac{\omega^2}{(c_L)^2} \right\} \times \left(k^2 - \frac{\omega^2}{(c_T)^2} \right) = 0.$$

So, the transverse displacement wave $u_2(x_1, t) = A_{22} e^{-i\omega \left(t - \frac{x_1}{v_{ph}^{(2)}} \right)}$ is purely elastic one. The longitudinal displacement wave and magnetic intensity wave are magnetoelastic ones, they are doubled

$$u_1(x_1, t) = A_{11} e^{g^{(1)}x_1} e^{-i\omega \left(t - \frac{x_1}{v_{ph}^{(1)}} \right)} + A_{13} e^{g^{(3)}x_1} e^{-i\omega \left(t - \frac{x_1}{v_{ph}^{(3)}} \right)}, \quad b_2(x_1, t) = A_{31} e^{g^{(1)}x_1} e^{-i\omega \left(t - \frac{x_1}{v_{ph}^{(1)}} \right)} + A_{33} e^{g^{(3)}x_1} e^{-i\omega \left(t - \frac{x_1}{v_{ph}^{(3)}} \right)}.$$

Case 3. The vector of magnetic induction involves the first component only $B^o = \{B_1^o; 0; 0\}$.

The wave equations are split partially: equations (20.38) and (20.41) save coupling

$$\mu \frac{\partial^2 u_2}{\partial x_1^2} - \rho \frac{\partial^2 u_2}{\partial t^2} + \frac{B_1^o}{\bar{\mu}} \frac{\partial b_2}{\partial x_1} = 0, \quad \frac{\partial^2 b_2}{\partial x_1^2} - \beta \frac{\partial b_2}{\partial t} = -\beta B_1^o \frac{\partial^2 u_2}{\partial x_1 \partial t},$$

but equation (20.37) degenerates into its elastic variant $(\lambda + 2\mu)\frac{\partial^2 u_1}{\partial x_1^2} - \rho\frac{\partial^2 u_1}{\partial t^2} = 0$,

The dispersion equation is as follows

$$\left\{ \frac{k^4}{\widehat{\mu}\widehat{\lambda}\omega} - k^2 \left[\frac{\omega^2}{(c_T)^2} \frac{1}{\widehat{\mu}\widehat{\lambda}\omega} + i \left(1 + \frac{(B_1^o)^2}{\rho\widehat{\mu}(c_T)^2} \right) \right] + i \frac{\omega^2}{(c_T)^2} \right\} \times \times \left(k^2 - \left(\omega^2 / (c_L)^2 \right) \right) = 0.$$

In this case, the purely elastic wave is the longitudinal displacement wave $u_1(x_1, t) = A_{11}e^{-i\omega\left(t - \frac{x_1}{v_{ph}^{(1)}}\right)}$ is purely elastic one. The transverse displacement wave and magnetic intensity wave are magnetoelastic ones, they are doubled

$$u_2(x_1, t) = A_{11}e^{g^{(2)}x_1} e^{-i\omega\left(t - \frac{x_1}{v_{ph}^{(2)}}\right)} + A_{13}e^{g^{(3)}x_1} e^{-i\omega\left(t - \frac{x_1}{v_{ph}^{(3)}}\right)}, \quad b_2(x_1, t) = A_{32}e^{g^{(2)}x_1} e^{-i\omega\left(t - \frac{x_1}{v_{ph}^{(2)}}\right)} + A_{33}e^{g^{(3)}x_1} e^{-i\omega\left(t - \frac{x_1}{v_{ph}^{(3)}}\right)}.$$

This exhausted the facts on magnetoelastic waves, which were planned to be expounded in the book.

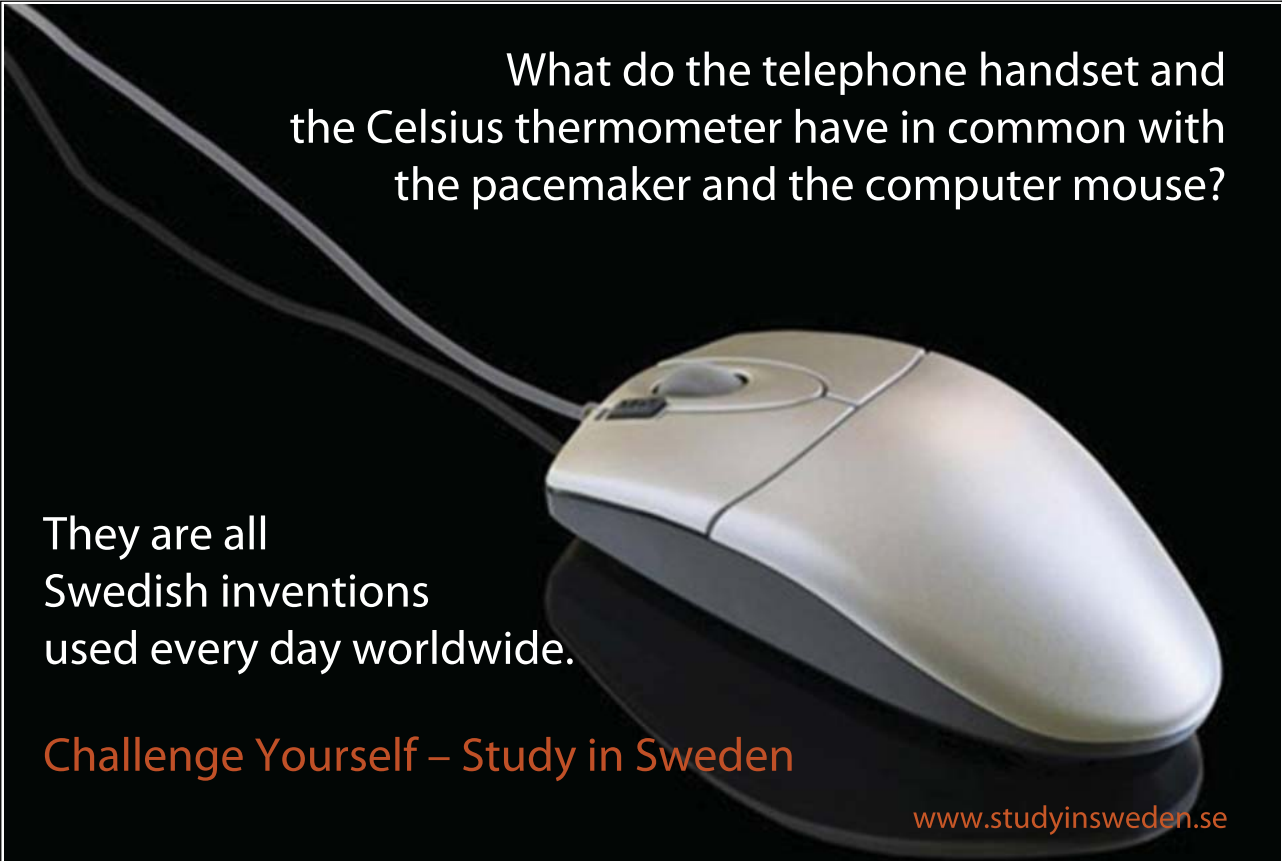

What do the telephone handset and the Celsius thermometer have in common with the pacemaker and the computer mouse?

They are all Swedish inventions used every day worldwide.

Challenge Yourself – Study in Sweden

www.studyinsweden.se

Please click the advert

Comments

The procedure of linearization in continuum mechanics is well described in the books (Germain, P 1973; Guz, AN 1999). Let us remember that the procedure is based on presence of three states – **natural, initial (no perturbed) and perturbed**. In the first state the stresses and strains are absent. For the third state, all the quantities are represented as sums of the corresponding quantity from the second state and perturbation. The perturbation is assumed the small quantity as compared with corresponding quantity from the second state.

Let the nonlinear equation $y = f(F, x)$ has the form in the first state $\hat{y} = f(\hat{F}, \hat{x})$, where \hat{F} are the functions known in the nonlinear problem; it will be transformed in the second state into $y_o = f(F_o, x_o)$ and then in the third state into $y_o + y = f(F_o + F, x_o + x)$ ($|F| \ll |F_o|, |x| \ll |x_o|$), where y, F, x are perturbations. Then the linearized equation is $y = \left[\left(\frac{\partial f}{\partial x} \right) \Big|_{F=F_o, x=x_o} \right] x$. It is the linear equation, but the coefficient $\left(\frac{\partial f}{\partial x} \right) \Big|_{F=F_o, x=x_o}$ also includes the parameters of the second, nonlinear, state.

Thus the linearized problems become the significantly complicate than corresponding linear ones.

Next comment is provoked by that lately many scholars are trying to unite many different properties of materials into one very complicate model like the thermo-visco-plastic-piezo-magnetoelasticity model. But at that the ancient sentence should be kept in mind:

**The Lord has been created the world in that way that all
what is simple is true, and all what is complicate is not true.**

Further reading

1. Brown, WF 1966, *Magnetoelastic interactions*. Springer Verlag, New York.
2. Chadwick, P 1957, 'Elastic wave propagation in a magnetic field'. Proceedings of the 9th ICTAM (Munich, 1956). Springer Verlag, New York.
3. Germain, P 1973, *Cours de mecanique des milieux continus*. Tome 1. Theorie generale, Masson et Cie, Editeurs, Paris. (In French).
4. Guz, AN 1999, *Fundamentals of the Three-Dimensional Theory of Stability of Deformable Bodies*. Springer Verlag, Berlin.
5. Knopoff, L 1955, 'The interaction between elastic wave motions and a magnetic field in electrical conductors', *J. Geophys. Res.*, vol. 60, no. 4, pp. 441-448.
6. Lines, ME & Glass, AM 1977, *Principles and Application of Ferroelectrics and Related Materials*, Clarendon Press, Oxford.
7. Maugin, GA 1985, *Nonlinear Electromechanical Effects and Applications*. Academic Press, New York.
8. Maugin, GA 1988, *Continuum Mechanics of Electromagnetic Solids*. North-Holland, Amsterdam.
9. Nowacki, W 1984, *Electromagnetic effects in solids*. PWN, Warszawa. (In Polish),(In Russian, 1986).
10. *Physical Acoustics* 1970, Mason, WP and Thurston, RN (eds) In 10 vols. Academic Press, New York.
11. Selezov, IT & Selezova, LV 1975, *Waves in Magnetoelastic Media*, Naukova Dumka, Kiev. (In Russian).
12. Selezov, IT & Korsunsky, SV 1991, *Non-stationary and Non-linear Waves in Electroconducting Media*. Naukova Dumka, Kiev. (In Russian).

Questions

- 20.1. Write the forming the Maxwell's system for electromagnetic media generalized Ampere's law, Faraday's law, Coulomb's law.
- 20.2. How many independent constitutive equations should be written for closing the system of equations in the coupled magnetoelasticity?
- 20.3. In the chapter, the boundary conditions of the coupled magnetoelasticity are mentioned in passing only. They are not necessary in studying the running plane waves. But they are necessary, for example, for studying the surface waves. Write the conditions on the plane boundary of two different by properties magnetoelastic media.
- 20.4. The study of mechanical and electromagnetic waves is usually separated. Which cogent argument exists for such a separation?
- 20.5. The linear relations between vectors of electric induction \vec{D} , electric field intensity \vec{E} , magnetic induction \vec{B} , magnetic field intensity \vec{H} have the form $D_m = \hat{\epsilon}_{mn} E_n$, $B_m = \hat{\mu}_{mn} H_n$. Can be the vectors \vec{E}, \vec{D} and \vec{B}, \vec{H} not parallel?
- 20.6. In studying the magnetoelastic waves, the electromagnetic field is assumed to be quasi-static. What it means relative to the electric induction \vec{D} ?

Please click the advert



Do you want your Dream Job?

More customers get their dream job by using RedStarResume than any other resume service.

RedStarResume can help you with your job application and CV.

Go to: Redstarresume.com
Use code "BOOKBOON" and save up to \$15

(enter the discount code in the "Discount Code Box")



Download free ebooks at bookboon.com

Afterword

Final comparative remarks on classical models of materials and corresponding basic properties of waves in materials

So, we tried to write the book in the clear and simple manner according to the Goethe sentence:

to sit down to table and write as if you have the million readers.

The main goal of the offered short course of twenty chapters-lectures was formulated as a coherent treatment of the theory of waves propagating in materials.

It is based on the concept of concentration on the correlation among six basic physical properties of materials (**elasticity, viscoelasticity, thermoelasticity, elastoplasticity, piezoelectricity, magnetoelasticity**), the reflecting these properties classical mechanical models and the corresponding to these models classical theories as well as the characteristic features of propagation of waves while the waves being analyzed within the framework of basic models on examples of the simplest types of waves.

The basic types of mathematical models of materials and the characteristic properties of simplest mechanical waves were analyzed from the position of similarity and distinction of models and the wave propagation process depending on the six mentioned above basic properties of materials, which are displayed, when the material being deformed.

Thus the book is devoted to a set of the most common types of models corresponding to certain theory –

**the theory of elastic waves, the theory of thermoelastic waves,
the theory of viscoelastic waves, the theory of elastoplastic waves,
the theory of piezoelectric waves, the theory of magnetoelastic waves.**

To begin with, all the models are constructing on the base of model of elastic behaviour by means of complication of the elastic model and introducing into the model new elements reflecting the presence of new property (viscosity or plasticity) or the new physical field (temperature or electromagnetic field).

The elastic behaviour was described by two basic models – **the classical linear model of elastic medium, the structural model of mixture of elastic components.**

These two models permit to describe all the family of linear wave effects in elastic materials. In the book, the main part of basic properties of running wave processes was analyzed. The linear model analysis was restricted to the plane waves, because the next analysis of the other models was concentrated on the plane wave mainly.

The **linear elastic plane harmonic waves** have the standard set of properties and the general description of a wave picture is as follows:

- three plane waves are propagating – the longitudinal wave, the horizontal transverse wave, and the vertical transverse wave;**
- all three waves are non-coupled and propagate independently;**
- the waves propagate with constant phase velocities, depending on properties of material only what means that the waves are not dispersive;**
- all the wave characteristics (amplitudes, wave numbers, frequencies, harmonic form of the wave profile) do not change during the propagation, what means that all the waves are not distorted.**

The same waves (linear elastic plane harmonic), while they being propagated in the two-component composite material and described therefore by **the structural linear model of mixture of two elastic components**, show more complicate wave picture:

- three plane waves are propagating in the form of two modes of each wave – two longitudinal waves, two horizontal transverse waves, and two vertical transverse waves;**
- two modes are propagating in two components of the mixture and in total four waves of every type are propagating simultaneously in the mixture;**
- all three types of waves are non-coupled and propagate independently, but existing for every type two modes are coupled;**
- the first mode is the slow wave and the second mode is the fast wave, the difference in phase velocities can reach many times;**
- the second mode is cut off for the low frequencies;**
- the waves propagate with phase velocities, depending nonlinearly on properties of material and frequency, that is, all the waves are dispersive waves;**
- all the wave characteristics (amplitudes, wave numbers, frequencies, harmonic form of the wave profile) do not change during the propagation, but in contrast to the classical case above they are changing with the frequency change;**
- two of four amplitudes of every type wave are arbitrary quantities, two other amplitudes depend nonlinearly on the properties of material and frequency.**

It should be mentioned that features of propagation of elastic plane waves are the basic ones for analysis of almost all the new kinds of waves – **viscoelastic, thermoelastic, piezoelectric, magnetoelastic**. But in one kind of waves only – **the elastoplastic waves** – the deviation from the plane waves is forcedly done. Here such type of uni-dimensional waves as the shock wave in rods is turned out the simplest type (essentially simpler than the plane waves) on which the main properties of elastoplastic waves can be shown.

Introducing into the linear elastic model the property of viscosity and constructing **the theory of viscoelasticity** change the basic properties of elastic wave propagation.

Two basic properties of elastic waves are preserved:

three plane waves are propagating – the longitudinal wave, the horizontal transverse wave, and the vertical transverse wave;
all three waves are non-coupled and propagate independently.

But two new properties are manifesting in the viscoelastic wave propagation:

the waves propagate with the phase velocities, depending nonlinearly on the properties of material and frequency what means that the waves are dispersive;
nearly all the wave characteristics (wave numbers, frequencies, harmonic form of the wave profile) do not change during the propagation; but amplitudes will have the additional exponential factor, which will include the attenuation coefficient and which will testify the amplitude attenuation with time.

Transition from the elastic waves to **the thermoelastic waves**, that is, taking into account an interaction of the mechanical fields and the temperature field, is described by two basic models – the model taking into account the interaction of mechanical and temperature fields (**the coupled model**) and the model, in which the influence of mechanical fields on temperature is neglected (**the partially uncoupled model**, in which the equation of heat conductivity doesn't include the coupling term) In both cases:

three plane mechanical waves –the longitudinal wave, the horizontal transverse wave, and the vertical transverse wave – and one thermal wave are propagating;
horizontal and vertical transverse (shear) waves are non-coupled and propagate independently, while the longitudinal (volume) wave and the thermal wave are coupled;
both longitudinal and thermal waves propagate in the form of two waves, basic parameters of which reflect the degree of coupling.

The presence of two forming the superposition waves both for longitudinal and the thermal waves is characteristic not only of the thermoelasticity. Such situation is occurring in the piezoelectricity and in the magnetoelasticity – if the mechanical fields and new additional physical field (temperature field, electric field, magnetic field) are interacting, then the wave picture will complicate and the number of mechanical and physical wave modes will doubled as compared with the pure elastic case. But these modes will be different for different degrees of coupling.

The partially coupled model of thermoelasticity describes two different modes consisting

of the pure elastic harmonic wave (which propagate with the constant phase velocity of elastic volume wave, is not dispersive wave and does not attenuate) and the harmonic diffusional heat wave, propagating with the depending on frequency phase velocity (hence the wave becomes dispersive one) and attenuating, while being propagated.

The coupled model of thermoelasticity includes two peer modes with distinguishable wave characteristics.

Both superposing modes are dispersive waves and both attenuating.

But if the coupling is weak, then

**the first mode is close to the mentioned above pure elastic harmonic wave;
the second mode is close to the harmonic diffusional heat wave.**

When coupling in the coupled model is assumed to be corresponding to the coupling in the partially coupled model (that is, the coupling term in the equation of heat conductivity tends to zero), then two dispersive and attenuating modes will degenerate into **the pure elastic harmonic wave and the harmonic diffusional wave.**

The property of plasticity introduces new features into the wave picture. **A fundamental distinction between the nonlinearly elastic and elastoplastic materials** consists in that when a structure member (rod, beam, plate and so on) being loaded, then the distinction between materials is absent (for example, the stress state in the plate will be inhomogeneous – in some parts of the plate the stresses do not exceed the yield limit and in other ones – exceed), then in the case, when the structure member being unloaded, then the structure member made of elastic material returns into the initial undeformed state, whereas in the same structure member made of elastoplastic material all the parts, in which the yield limit was exceeded (the so called plasticity zones) will be in the state of unremovable deformed state.

Please click the advert

Brain power

By 2020, wind could provide one-tenth of our planet's electricity needs. Already today, SKF's innovative know-how is crucial to running a large proportion of the world's wind turbines.

Up to 25 % of the generating costs relate to maintenance. These can be reduced dramatically thanks to our systems for on-line condition monitoring and automatic lubrication. We help make it more economical to create cleaner, cheaper energy out of thin air.

By sharing our experience, expertise, and creativity, industries can boost performance beyond expectations. Therefore we need the best employees who can meet this challenge!

The Power of Knowledge Engineering

Plug into The Power of Knowledge Engineering.
Visit us at www.skf.com/knowledge

SKF

Download free ebooks at bookboon.com

The problem of waves in elastoplastic materials seems to be very distinguishing as compared with the elastic materials. The harmonic waves in elastic materials are considered as the simplest kind of waves permitting the analytical approach. In contrast to this case, an analysis of harmonic waves in elastoplastic materials becomes markedly more complicated owing to necessity to describe unloading on each oscillation. Basically, unloading is the key word in elastoplasticity and can not be ignored in any problem including the wave problems. Fortunately, the problem of shock wave propagation in elastoplastic materials is not so complicated.

An analysis of shock waves in the rod, which has been carried out by many prominent scientists, shows two main effects:

- The initial pulse shape is changed during the wave propagation.**
- The initial pulse amplitude is attenuated during the wave propagation.**

Two cases should be distinguished:

Case 1. The maximal value of explosion compression at the bar end does not exceed the proportionality limit. The strain will propagate along the rod with the sound velocity $c_o = \sqrt{(E/\rho_o)}$. The rod particle at the distance x from the rod end takes at moment $t = (x/c_o)$ step-wise the maximal strain corresponding to the maximal compression. If the compression at the rod end is changed, then the strain at x repeats this change.

Case 2. The maximal value of explosion compression at the bar end exceeds the proportionality limit. The rod particle at the distance x from the rod end will increase continuously starting with the moment $t = (x/c_o)$ by the law $\sigma = \sigma(\varepsilon)$ up to some value, which will be less the maximal strain corresponding to the maximal compression at the rod end. Further the strain will decrease depending both on the compression change at the rod end and the law $\sigma = \sigma(\varepsilon)$. So, some moment t exists for given distance x in the plane (x, t) , from which the unloading is starting. In other words, certain curve exists in the plane (x, t) , on the one side of which the loading occurs and on other side of which the unloading occurs. This curve is called the unloading wave and motion of this curve defines the unloading wave motion.

If the load at the rod end $F(t)$ is known, then it has a representation

$$F(t) = \frac{1}{2} \{ \sigma[\varepsilon_o(x_1)] + \sigma[\varepsilon_o(x_2)] \} + \frac{E}{2c_o} \{ \psi[\varepsilon_o(x_1)] + \psi[\varepsilon_o(x_2)] \}$$

and the unloading wave $t = f(x)$ can be found from the system of equations

$$[f(x_1) - t]c_o = x_1, [f(x_2) - t]c_o = x_2, f(x_1)[\varepsilon_o(x_1)]c_R = x_1, f(x_2)[\varepsilon_o(x_2)]c_R = x_2,$$

where the unknown function ε_o corresponds to the unloading wave.

Last two kinds of waves are associated with interaction of elastic and electromagnetic fields and two different kinds of materials – piezoelectrics and conductors.

The models of piezoelectric deformation are applicable to the piezoelectrics – the particular class of dielectrics, in which two piezoelectric effects are manifesting – the direct and inverse piezoelectric effects.

The models of piezoelectricity is concerning mainly not on materials with classical symmetry – isotropic, transversely isotropic (monotropic) and orthotropic. These models introduce into consideration new piezoactive materials with three kinds of physical properties – the elastic constants c_{iklm} , the piezoelectric constants e_{ikm} , the dielectric permeabilities χ_{ik} or the dielectric susceptibilities $\tilde{\epsilon}_{ik}$ – and take into account the diverse levels of symmetry of physical properties, which include the materials with the classical symmetry as a very particular case.

**The classical linear model of piezoelectric wave propagation
includes the coupled system of four equations relative
to displacements u_k and electric potential φ .**

Four plane piezoelectric waves are propagating in the piezoactive materials – three mechanical and one electric. The basic facts on mechanical plane waves are as follows:

Three mechanical independent plane waves with different phase velocities can propagate in the material.

These waves propagate in directions, which are mutually perpendicular.

The mechanical wave propagating in direction most close to the polarization direction is called the quasi-longitudinal wave. Other two mechanical waves are called the quasi-transverse waves.

The piezoelectric mechanical waves and corresponding elastic waves will distinguish by amplitudes and phase velocities only.

Plane mechanical waves in piezoactive materials can be piezoactive and not piezoactive, that is, the electric field can effect on these waves or not; as a rule, one or two of three different plane waves are not piezoactive and coincide with the corresponding elastic wave.

Propagation of three plane mechanical waves will be accompanied by one plane electric wave:

The electric field will propagate in the form of plane wave with phase velocities associated with piezoactive mechanical plane waves.

The structural model of piezoelectric behavior has been offered for the third generation of piezo-active materials – the piezopowders. The model is based on the concept of two-component mixture, when the matrix is lead or paraffine and fillers are made of the piezoactive material.

In this case, the main features of plane mechanical waves will be as follows:

Every piezoelectric plane wave is split into two modes both dispersive.

The second mode is always faster one and it is cut off for low frequencies.

The first mode is dispersive in the area around the cut off frequency.

The strong dispersion is observed for the second mode in the area to the right side from the cut off frequency.

The energy of the initial harmonic signal is distributed among four waves – two modes in the fillers and two modes in the lead (paraffine).

Propagation of three doubled plane mechanical waves will be accompanied by one doubled plane electric wave:

The electric field will propagate in the form of two modes of plane wave with phase velocities associated with piezoelectric mechanical plane waves.

The models of magnetoelastic deformation are developed for description of behavior of conducting elastic materials under action of electromagnetic field and mechanical forces, when the electromagnetic field and strain field interact.

Three mechanical parameters (**the Kirchhoff stress tensor t_{ik}** , **the Green strain tensor ε_{ik}** , **the displacement vector $\vec{u} = \{u_k\}$**) and four electrodynamic parameters (**the vector of electric field intensity $\vec{E} = \{E_n\}$** , **the vector of magnetic field intensity $\vec{H} = \{H_n\}$** , **the vector of electric induction $\vec{D} = \{D_n\}$** , **the vector of magnetic induction $\vec{B} = \{B_n\}$**) are usually used in the theory of magneto-elasticity.

Trust and responsibility

NNE and Pharmaplan have joined forces to create NNE Pharmaplan, the world's leading engineering and consultancy company focused entirely on the pharma and biotech industries.

Inés Aréizaga Esteva (Spain), 25 years old
Education: Chemical Engineer

– You have to be proactive and open-minded as a newcomer and make it clear to your colleagues what you are able to cope. The pharmaceutical field is new to me. But busy as they are, most of my colleagues find the time to teach me, and they also trust me. Even though it was a bit hard at first, I can feel over time that I am beginning to be taken seriously and that my contribution is appreciated.



NNE Pharmaplan is the world's leading engineering and consultancy company focused entirely on the pharma and biotech industries. We employ more than 1500 people worldwide and offer global reach and local knowledge along with our all-encompassing list of services.
nnepharmaplan.com

nne pharmaplan®

Please click the advert

The theory is essentially nonlinear and has not the linear analog. But the basic nonlinear equations can be linearized. Practically the electric and magnetic fields are linearized with condition that the initial magnetic field is strong and constant $\vec{H}^o = const$. Also, the fact that the electromagnetic waves are faster significantly the mechanical waves is used, what means that frequencies of electro-magnetic waves are essentially more than mechanical waves ones for the fixed wave length of mechanical wave.

Therefore the electromagnetic field can be treated as the quasi-static one, when the mechanical waves being studied. In this case, the basic system of equations is simplified to two coupled vector equations with nonlinearly depending on the initial magnetic field values coefficients. Solving this system gives two vector functions – the displacement \vec{u} and the magnetic field intensity \vec{h} . The electric field intensity \vec{e} , the electric current density \vec{j} , and the magnetic induction \vec{B} can be determined from the simplified Maxwell equations.

The plane wave problems are studied for two cases of conductivity: **the real conductivity** and **the perfect conductivity**, which is characterized by the value of conductivity $\hat{\lambda} = \infty$.

The main properties of plane waves for the case of perfect conductivity are as follows:

All the waves are magnetoelastic ones in the sense that the parameters of waves (phase velocities, wave numbers, coefficients of amplitude distribution) depend nonlinearly on the values of magnetic induction.

All the waves are dispersive ones owing to nonlinear dependence of dispersion equation coefficients M_2, M_0 on frequency.

Two only A_{11}, A_{22} of four amplitudes A_{mn} are arbitrary, other two amplitudes are as follows

$A_{21} = l_1(\omega)A_{11}$, $A_{12} = l_2(\omega)A_{22}$, **the matrix of amplitude distribution $\begin{pmatrix} 1 & l_2 \\ l_1 & 1 \end{pmatrix}$ can be introduced. The matrix shows that values of amplitudes will change with the frequency change.**

All the types of waves (mechanical displacement \vec{u} , magnetic induction \vec{b} , electric field intensity \vec{e} , electric current density \vec{j}) will be doubled – two waves with distinguishing phase velocities will propagate simultaneously, the fast and the slow waves.

Each wave does not attenuate and save its harmonic profile over all the distance of propagation.

The case of real conductivity is richer on new wave effects:

All the waves are magnetoelastic ones from the standpoint that the parameters of waves (phase velocities, wave numbers, attenuation coefficients, coefficients of amplitude distribution) depend nonlinearly on the values of magnetic induction.

All the waves are dispersive ones owing to nonlinear dependence of dispersion equation factors $\check{M}_4, \check{M}_2, \check{M}_0$ on frequency.

Three only A_{11}, A_{22}, A_{33} of nine amplitudes A_{mn} are arbitrary, other six amplitudes are as follows

$$A_{21} = l_{12}(\omega)A_{11}, \quad A_{31} = l_{13}(\omega)A_{11}, \quad A_{12} = l_{21}(\omega)A_{22},$$

$$A_{32} = l_{23}(\omega)A_{22}, \quad A_{13} = l_{31}(\omega)A_{33}, \quad A_{33} = l_{33}(\omega)A_{33},$$

the matrix of amplitude distribution $\begin{pmatrix} 1 & l_{21} & l_{31} \\ l_{12} & 1 & l_{32} \\ l_{13} & l_{23} & 1 \end{pmatrix}$ can be evaluated.

The matrix shows that relative values of amplitudes will change with the frequency change.

All the types of waves (mechanical displacement \vec{u} , magnetic induction \vec{b} , electric field intensity \vec{e} , electric current density \vec{j}) will be tripled – three waves with distinguishing phase velocities will propagate simultaneously. Each wave attenuates by the exponential law and saves its frequency over all the distance of propagation.

Thus, in the book, six basic types of mechanical properties – elasticity, viscoelasticity, thermoelasticity, elastoplasticity, piezoelectricity, magnetoelasticity – are considered and commented, six basic types of waves – elastic, viscoelastic, thermoelastic elastoplastic, piezoelectric, magnetoelastic – are described, commented and compared. The basic features of all the waves are shown with comments of similarity and distinction.

Acknowledgment. The genesis of this book can be found in author's years of research and teaching while a head of department at SP Timoshenko Institute of Mechanics (National Academy of Sciences of Ukraine), a member of Centre for Micro- and Nanomechanics at School of Engineering of University of Aberdeen (Scotland) and a professor at Physical-Mathematical Faculty of National Technical University of Ukraine "KPI".