

2.76 / 2.760 Lecture 3: Large scale

Big-small intuition

System modeling

Big history

Big problems

Flexures

Design experiment

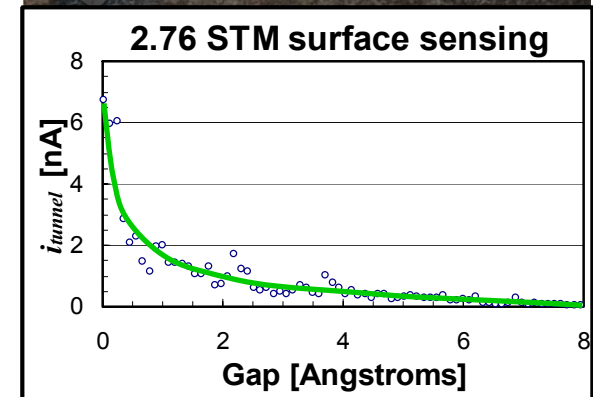
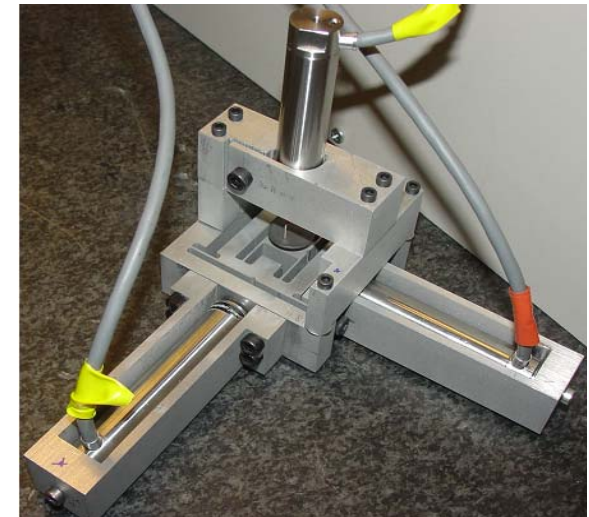
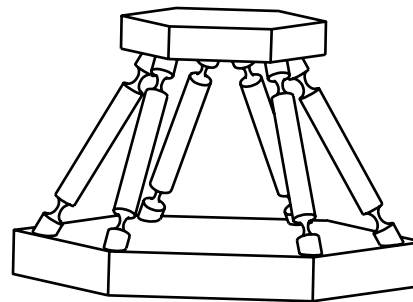
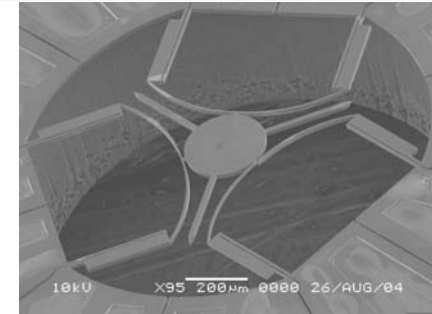
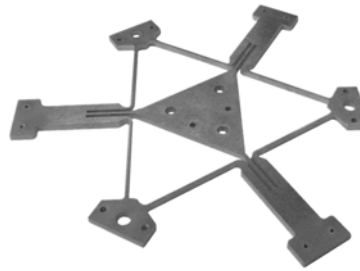

Cross-scale coupling

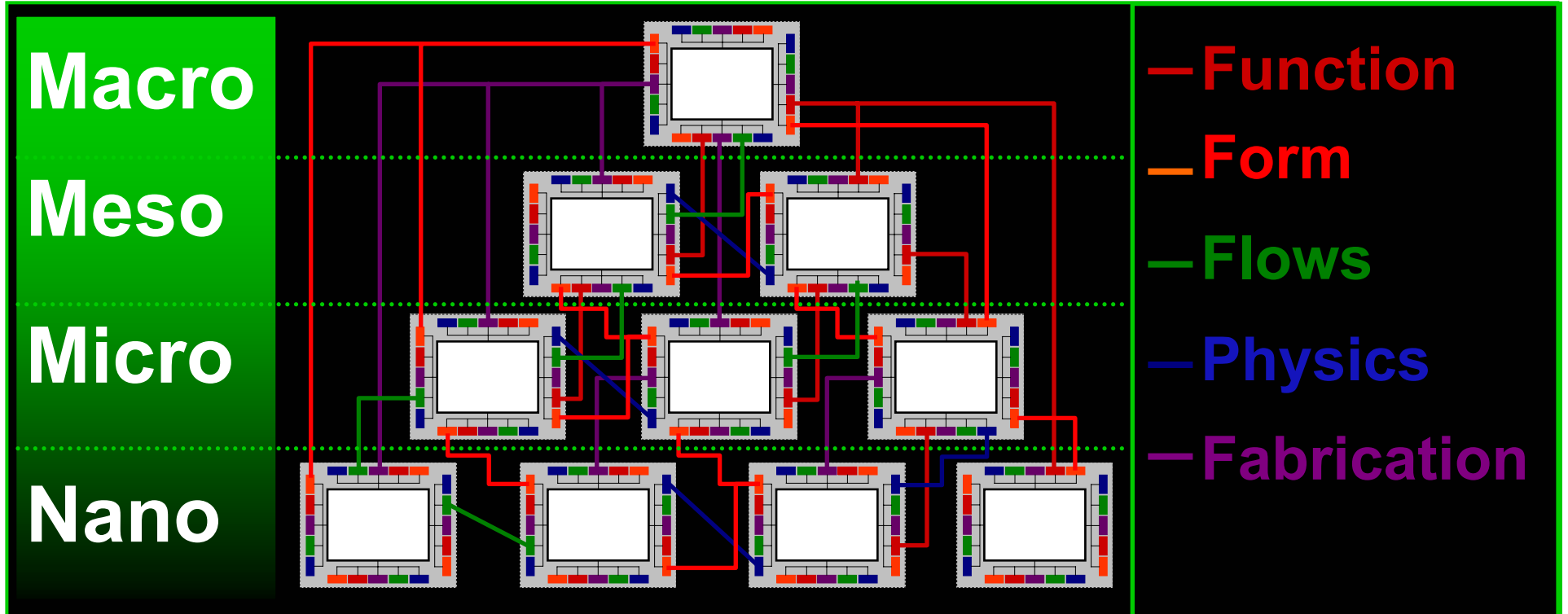

Function	Form	Flow	Physics	Fabrication
What	Geometry	Mass	Application	Compatibility
Who	Motion	Momentum	Modeling	Quality
Why	Interfaces	Energy	Limiting	Rate
Where	Constraints	Information	Dominant	Cost
Etc...	Etc...	Etc...	Etc...	Etc...

Short experiment

- (1) What cross-scale incompatibilities (5Fs) do you notice?**
- (2) What obstacles must be overcome to enable interaction between large/small?**

Time Limit: 5 minutes

Email results to me when time is called

Bulleted points please

Discussion

What was the nature of the trouble?

Comment on

- Strain
- Control/sensing
- Momentum
- Noise

What does this tell you about sensitivity and resolution / discretization?

Stage 1: Synthesis & selection

- Big issues
- Selection

Stage 2: Detailed design

- Analysis
- Optimization

- **Function**
- **Form**
- **Flows**
- **Physics**
- **Fabrication**

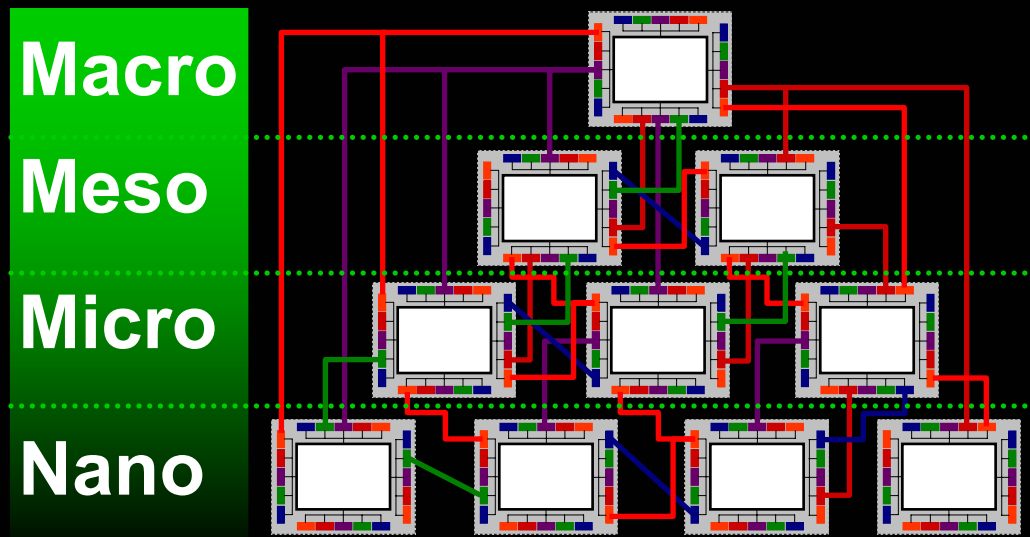

Cake Or Death ?

Is this a difficult decision?

- Decision making is differential
- Difference is indicated by model
- Model is supported by relationship

What determines quality of model?

Modeling and decision making

Determinism

- Does the system obey cause-effect (as observed)?
- Systematic error, random error

Everything

Repeatability

- How identical are repeated results?

Accuracy

- How close is the result to reality?

Non-dimensional analysis

- Qualitative & quantitative
- Rational process

*Experience
or
Relative importance*

Necessary &
Sufficient

Input-output mapping

$$O_{MuSS} = G(SR) \cdot I_{MuSS}$$

$$\begin{array}{c}
 O_{Macro} \\
 O_{Meso} \\
 O_{Micro} \\
 O_{Nano}
 \end{array}
 \left|
 \begin{array}{cccc}
 f_{11} \left(SR_{\frac{Macro}{Macro}} \right) & f_{12} \left(SR_{\frac{Meso}{Macro}} \right) & f_{13} \left(SR_{\frac{Micro}{Macro}} \right) & f_{14} \left(SR_{\frac{Nano}{Macro}} \right) \\
 f_{21} \left(SR_{\frac{Macro}{Meso}} \right) & f_{22} \left(SR_{\frac{Meso}{Meso}} \right) & f_{23} \left(SR_{\frac{Micro}{Meso}} \right) & f_{24} \left(SR_{\frac{Nano}{Meso}} \right) \\
 f_{31} \left(SR_{\frac{Macro}{Micro}} \right) & f_{32} \left(SR_{\frac{Meso}{Micro}} \right) & f_{33} \left(SR_{\frac{Micro}{Micro}} \right) & f_{34} \left(SR_{\frac{Nano}{Micro}} \right) \\
 f_{41} \left(SR_{\frac{Macro}{Nano}} \right) & f_{42} \left(SR_{\frac{Meso}{Nano}} \right) & f_{43} \left(SR_{\frac{Micro}{Nano}} \right) & f_{44} \left(SR_{\frac{Nano}{Nano}} \right)
 \end{array}
 \right|
 \begin{array}{c}
 I_{Macro} \\
 I_{Meso} \\
 I_{Micro} \\
 I_{Nano}
 \end{array}$$

Conceptual

Input-output mapping

$$O_{MuSS} = G(SR) \cdot I_{MuSS}$$

$$\begin{array}{c}
 O_{Macro} \\
 O_{Meso} \\
 O_{Micro} \\
 O_{Nano}
 \end{array}
 =
 \begin{array}{cccc}
 C_{11} \cdot \left(\frac{SR_{Macro}}{Macro} \right)^{A_{11}} & C_{12} \cdot \left(\frac{SR_{Meso}}{Macro} \right)^{A_{12}} & C_{13} \cdot \left(\frac{SR_{Micro}}{Macro} \right)^{A_{13}} & C_{14} \cdot \left(\frac{SR_{Nano}}{Macro} \right)^{A_{14}} \\
 C_{21} \cdot \left(\frac{SR_{Macro}}{Meso} \right)^{A_{21}} & C_{22} \cdot \left(\frac{SR_{Meso}}{Meso} \right)^{A_{22}} & C_{23} \cdot \left(\frac{SR_{Micro}}{Meso} \right)^{A_{23}} & C_{24} \cdot \left(\frac{SR_{Nano}}{Meso} \right)^{A_{24}} \\
 C_{31} \cdot \left(\frac{SR_{Macro}}{Micro} \right)^{A_{31}} & C_{32} \cdot \left(\frac{SR_{Meso}}{Micro} \right)^{A_{32}} & C_{33} \cdot \left(\frac{SR_{Micro}}{Micro} \right)^{A_{33}} & C_{34} \cdot \left(\frac{SR_{Nano}}{Micro} \right)^{A_{34}} \\
 C_{41} \cdot \left(\frac{SR_{Macro}}{Nano} \right)^{A_{41}} & C_{42} \cdot \left(\frac{SR_{Meso}}{Nano} \right)^{A_{42}} & C_{43} \cdot \left(\frac{SR_{Micro}}{Nano} \right)^{A_{43}} & C_{44} \cdot \left(\frac{SR_{Nano}}{Nano} \right)^{A_{44}}
 \end{array}
 \cdot
 \begin{array}{c}
 I_{Macro} \\
 I_{Meso} \\
 I_{Micro} \\
 I_{Nano}
 \end{array}$$

Equivalent

What might G look like?

“Ideal” or perfect scale interaction

$$\begin{array}{c}
 \left| \begin{array}{c} O_{Macro} \\ O_{Meso} \\ O_{Micro} \\ O_{Nano} \end{array} \right| \sim \left| \begin{array}{cccc} 10^0 & 10^3 & 10^6 & 10^9 \\ 10^{-3} & 10^0 & 10^3 & 10^6 \\ 10^{-6} & 10^{-3} & 10^0 & 10^3 \\ 10^{-9} & 10^{-6} & 10^{-3} & 10^0 \end{array} \right| \cdot \left| \begin{array}{c} I_{Macro} \\ I_{Meso} \\ I_{Micro} \\ I_{Nano} \end{array} \right| \longrightarrow G_p = \left| \begin{array}{cccc} 10^0 & 10^3 & 10^6 & 10^9 \\ 10^{-3} & 10^0 & 10^3 & 10^6 \\ 10^{-6} & 10^{-3} & 10^0 & 10^3 \\ 10^{-9} & 10^{-6} & 10^{-3} & 10^0 \end{array} \right|
 \end{array}$$

What does $|G_p^{ij} / G_{ij}|$ look like?

Why is this useful?

How will we use it?

$$G = \left| \begin{array}{cccc} 10^{100} & 10^3 & 10^6 & 10^{20} \\ 10^{-3} & 10^0 & 10^3 & 10^6 \\ 10^{-6} & 10^{-3} & 10^0 & 10^3 \\ 10^{-9} & 10^{-6} & 10^{-3} & 10^0 \end{array} \right|$$

Example: STM

$$i = C \cdot e^{(-2 \cdot K \cdot gap)}$$

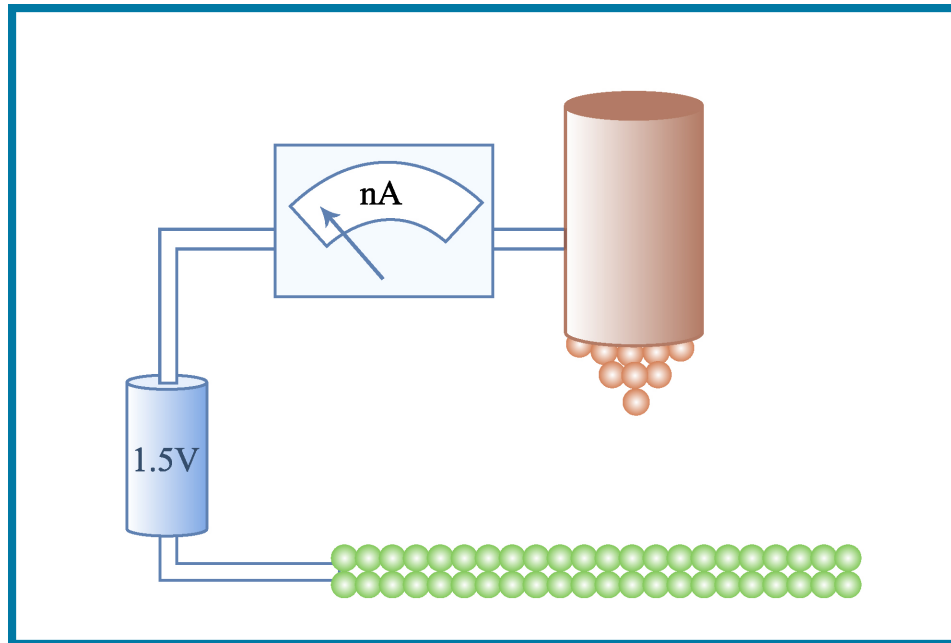

Figure by MIT OCW.

Is this the whole story?

Example: STM Signal

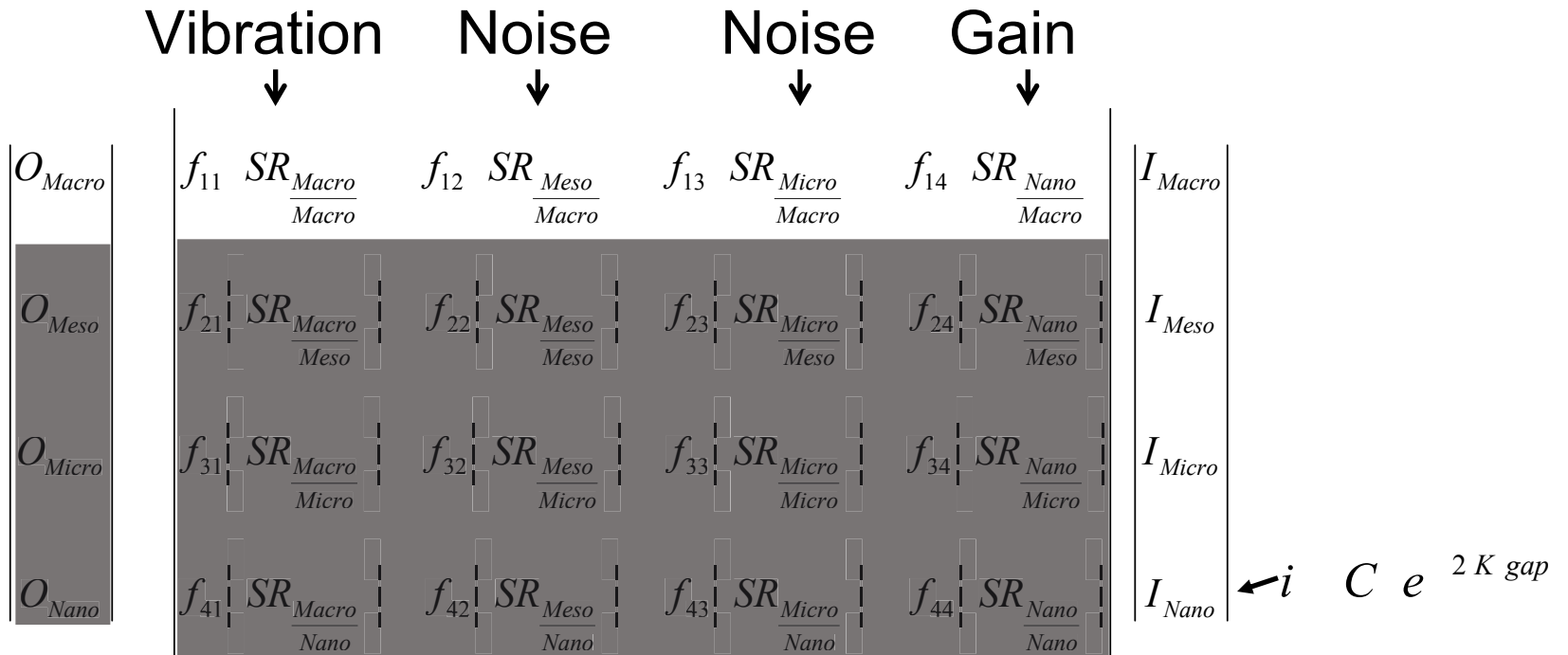
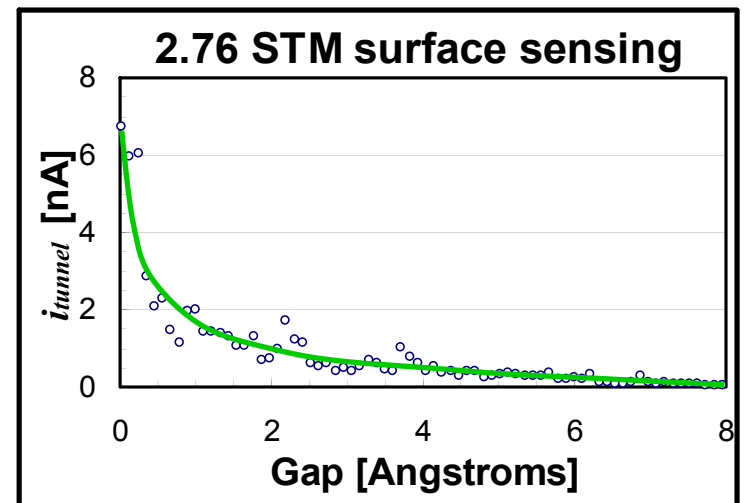

Image removed for copyright reasons.
Source: <http://www.almaden.ibm.com>



Example: STM Displacement

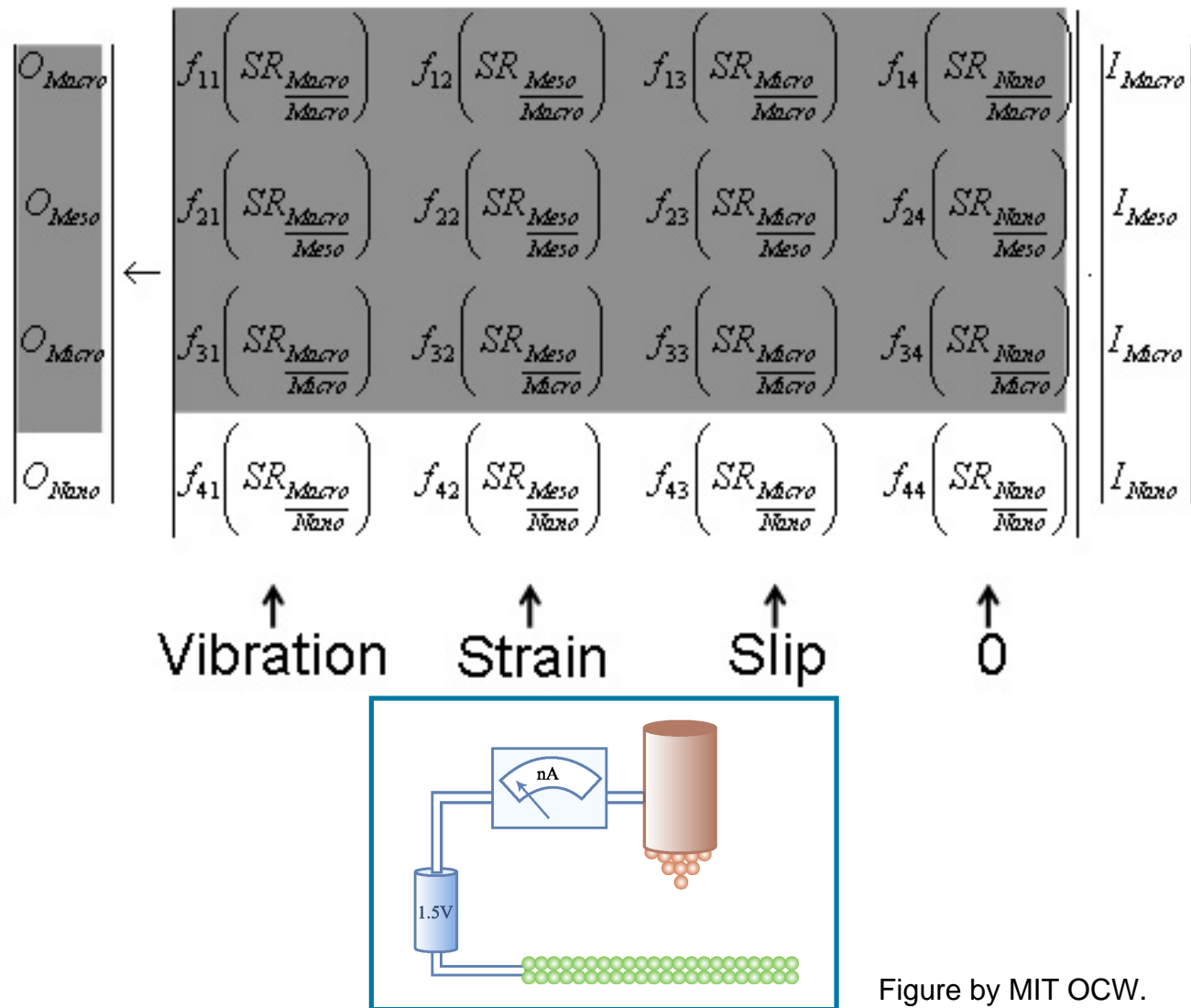

Figure by MIT OCW.

Purpose of today

$$\begin{array}{c}
 O_{Macro} \\
 O_{Meso} \\
 O_{Micro} \\
 O_{Nano}
 \end{array}
 =
 \begin{array}{cccc}
 f_{11} \left(\begin{array}{c} SR_{Macro} \\ Macro \end{array} \right) & f_{12} \left(\begin{array}{c} SR_{Meso} \\ Macro \end{array} \right) & f_{13} \left(\begin{array}{c} SR_{Micro} \\ Macro \end{array} \right) & f_{14} \left(\begin{array}{c} SR_{Nano} \\ Macro \end{array} \right) \\
 f_{21} \left(\begin{array}{c} SR_{Macro} \\ Meso \end{array} \right) & f_{22} \left(\begin{array}{c} SR_{Meso} \\ Meso \end{array} \right) & f_{23} \left(\begin{array}{c} SR_{Micro} \\ Meso \end{array} \right) & f_{24} \left(\begin{array}{c} SR_{Nano} \\ Meso \end{array} \right) \\
 f_{31} \left(\begin{array}{c} SR_{Macro} \\ Micro \end{array} \right) & f_{32} \left(\begin{array}{c} SR_{Meso} \\ Micro \end{array} \right) & f_{33} \left(\begin{array}{c} SR_{Micro} \\ Micro \end{array} \right) & f_{34} \left(\begin{array}{c} SR_{Nano} \\ Micro \end{array} \right) \\
 f_{41} \left(\begin{array}{c} SR_{Macro} \\ Nano \end{array} \right) & f_{42} \left(\begin{array}{c} SR_{Meso} \\ Nano \end{array} \right) & f_{43} \left(\begin{array}{c} SR_{Micro} \\ Nano \end{array} \right) & f_{44} \left(\begin{array}{c} SR_{Nano} \\ Nano \end{array} \right)
 \end{array}
 \cdot
 \begin{array}{c}
 I_{Macro} \\
 I_{Meso} \\
 I_{Micro} \\
 I_{Nano}
 \end{array}$$

Mechanical gain factors to make big machines work with little machines

What will this be applied to?

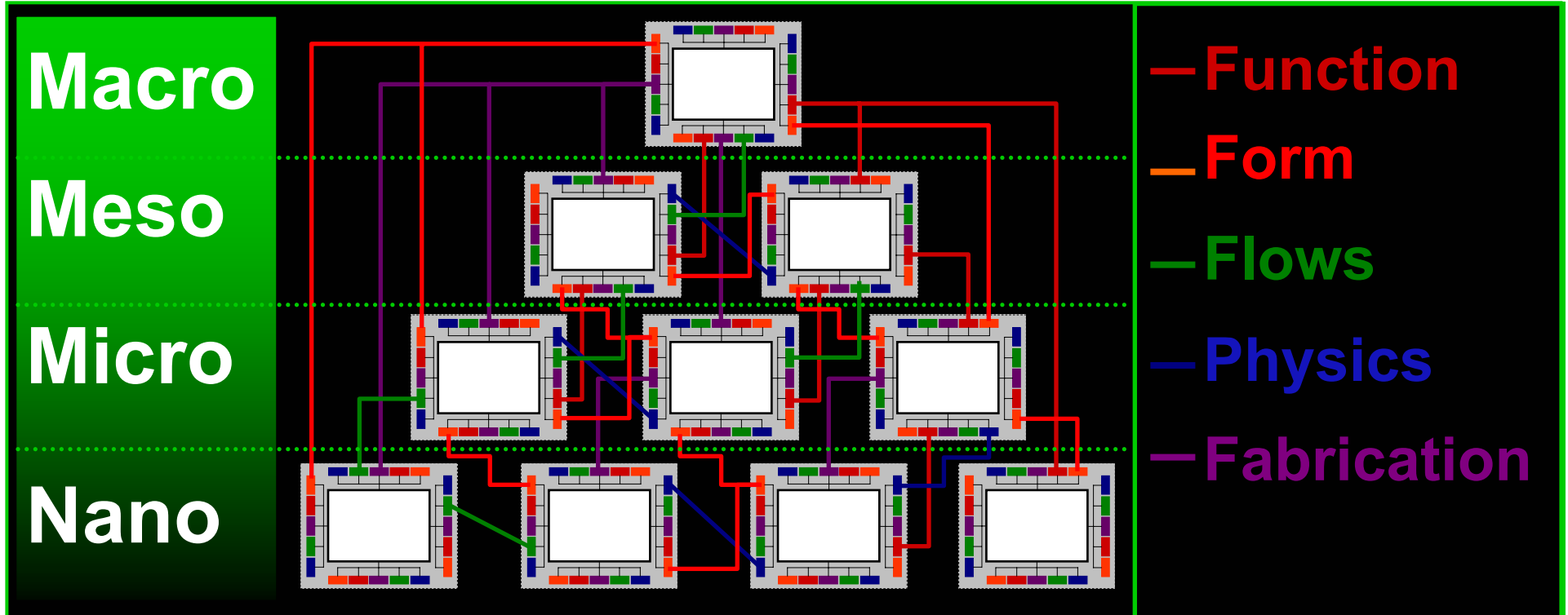

Function	Form	Flow	Physics	Fabrication
What	Geometry	Mass	Application	Compatibility
Who	Motion	Momentum	Modeling	Quality
Why	Interfaces	Energy	Limiting	Rate
Where	Constraints	Information	Dominant	Cost
Etc...	Etc...	Etc...	Etc...	Etc...

**Early big
machines made to
work with the
small**

Big machines working with the small

What is the most critical requirements for a large-scale machine to live in a MuSS?

Motion stability, resolution, repeatability

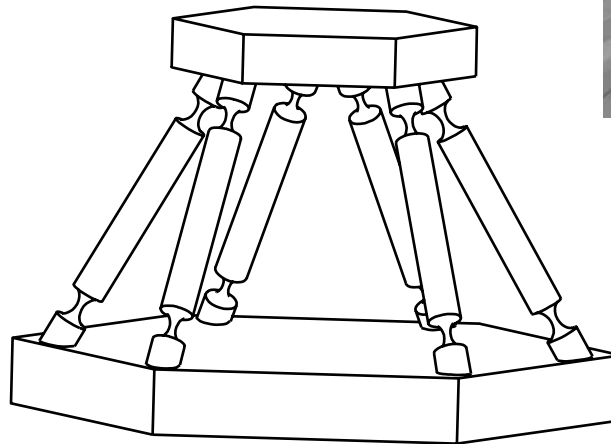
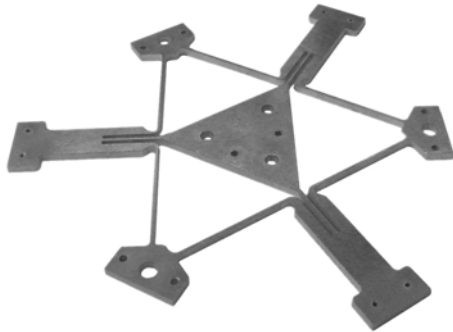
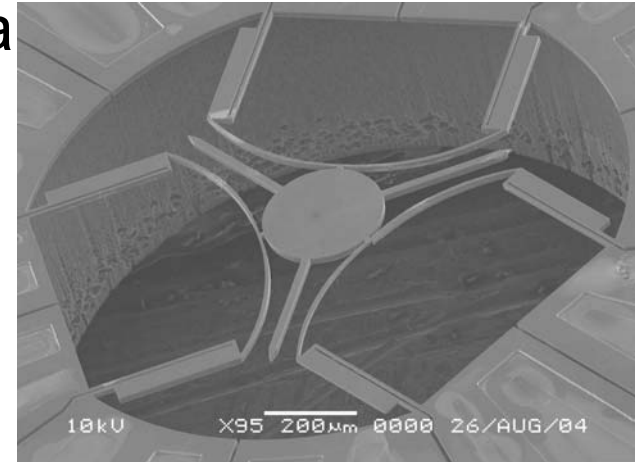

Two diagrams removed
for copyright reasons.

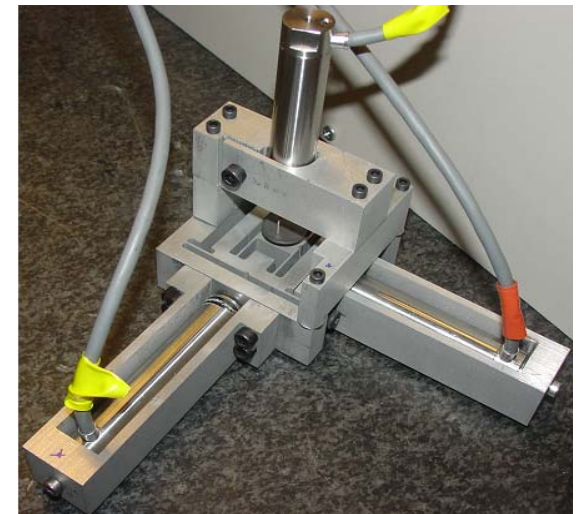

Strain management

Everything is compliant

- Strain error scales with size
- Large scale parts are kinematic bullies

Generally require “freedom to strain” to prevent over constraint & energy storage

Generally seek to minimize strain

Mechanism/fixture/structure design

- Necessary & sufficient constraint topology → concepts
- **Exact constraint**

History of compliant machines

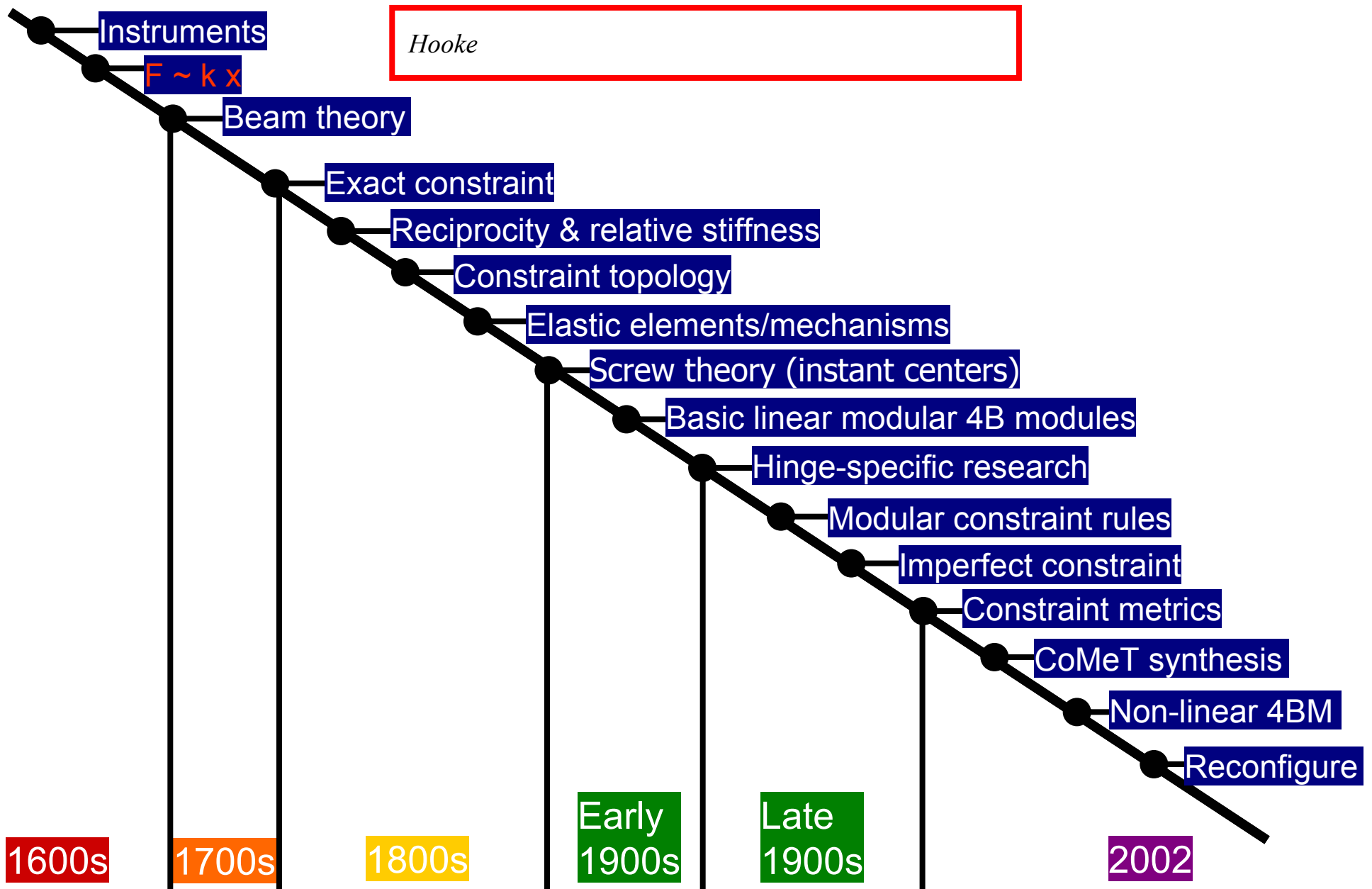

History of compliant machines

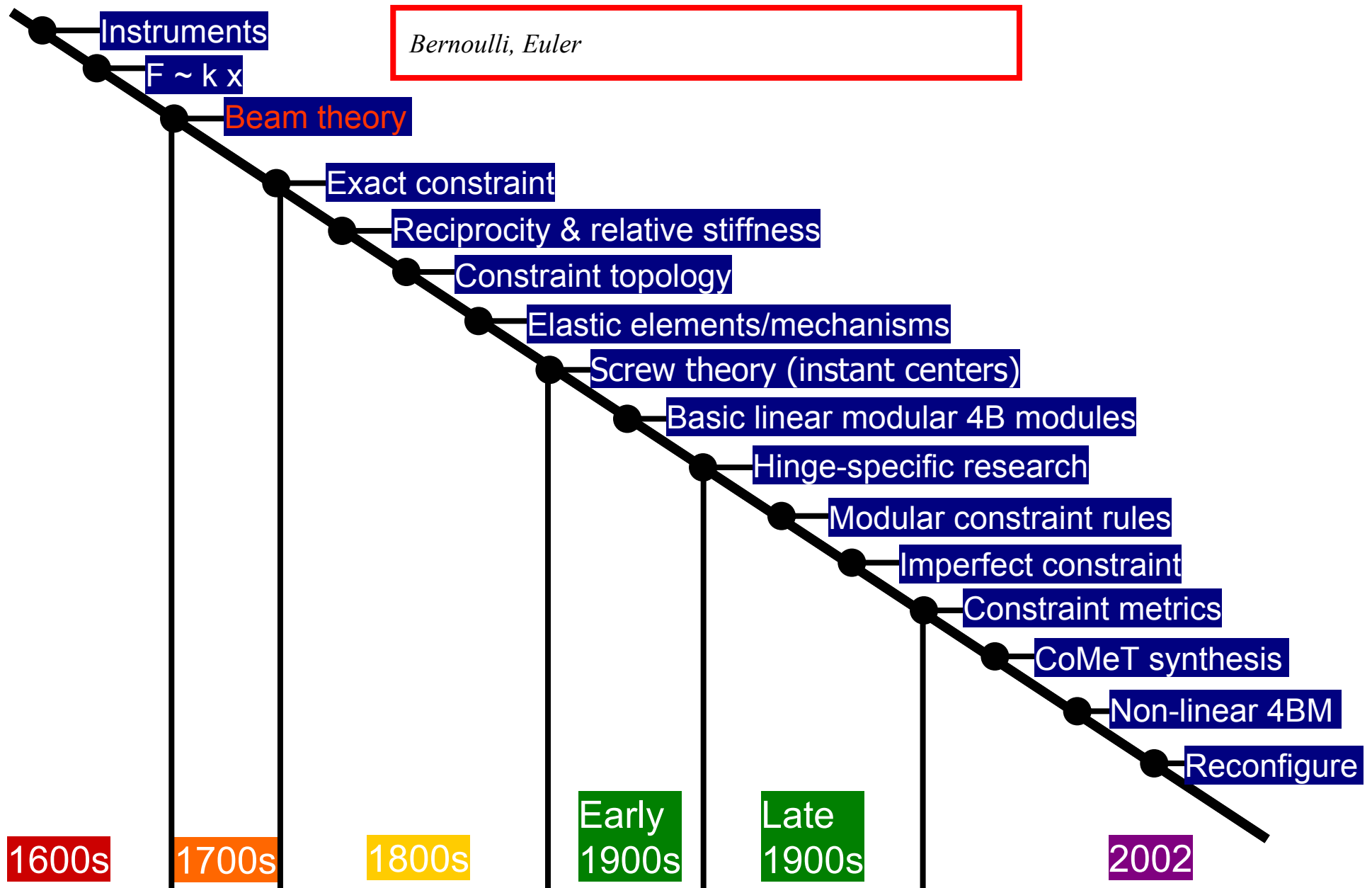

History of compliant machines

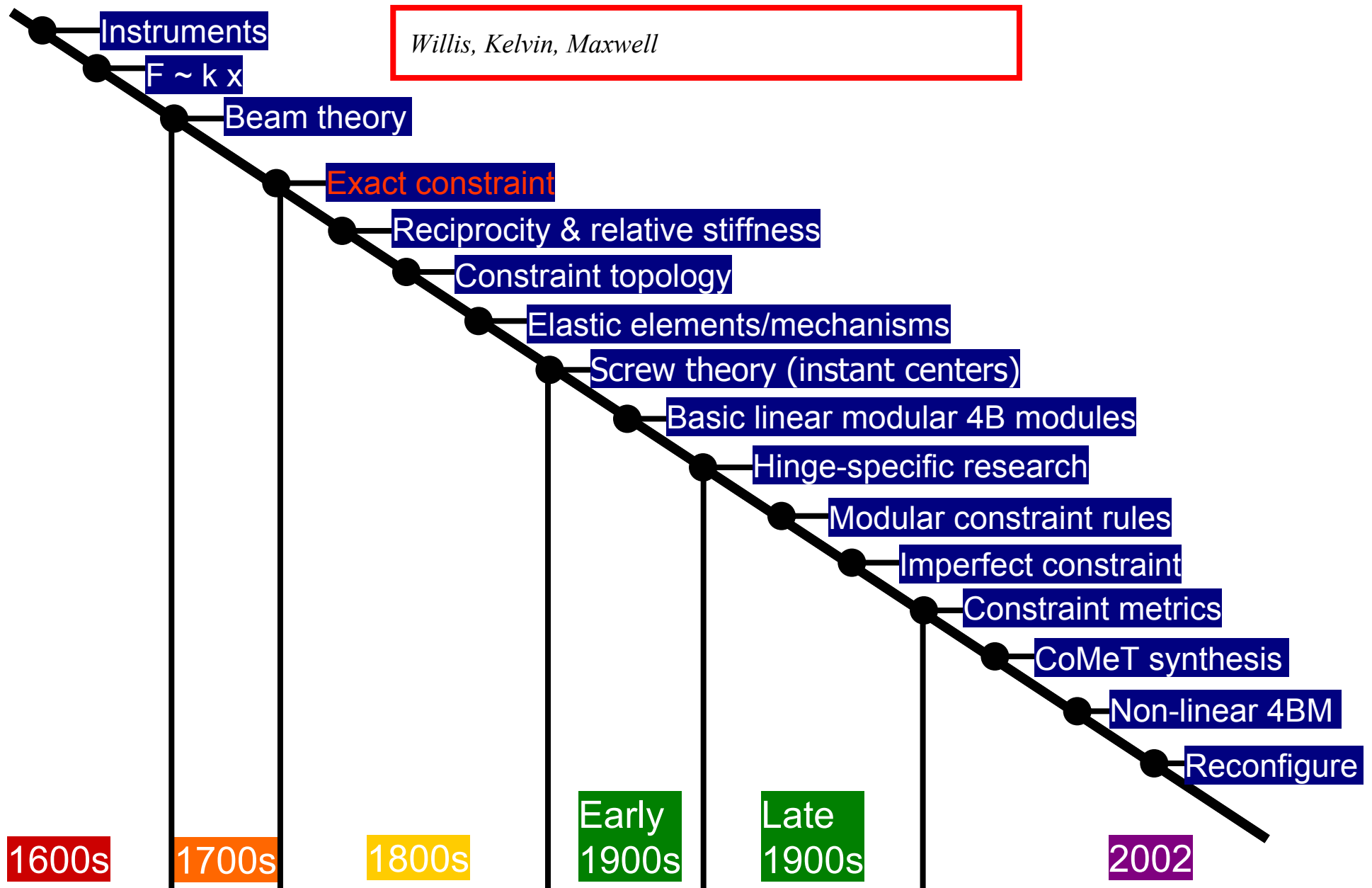

History of compliant machines

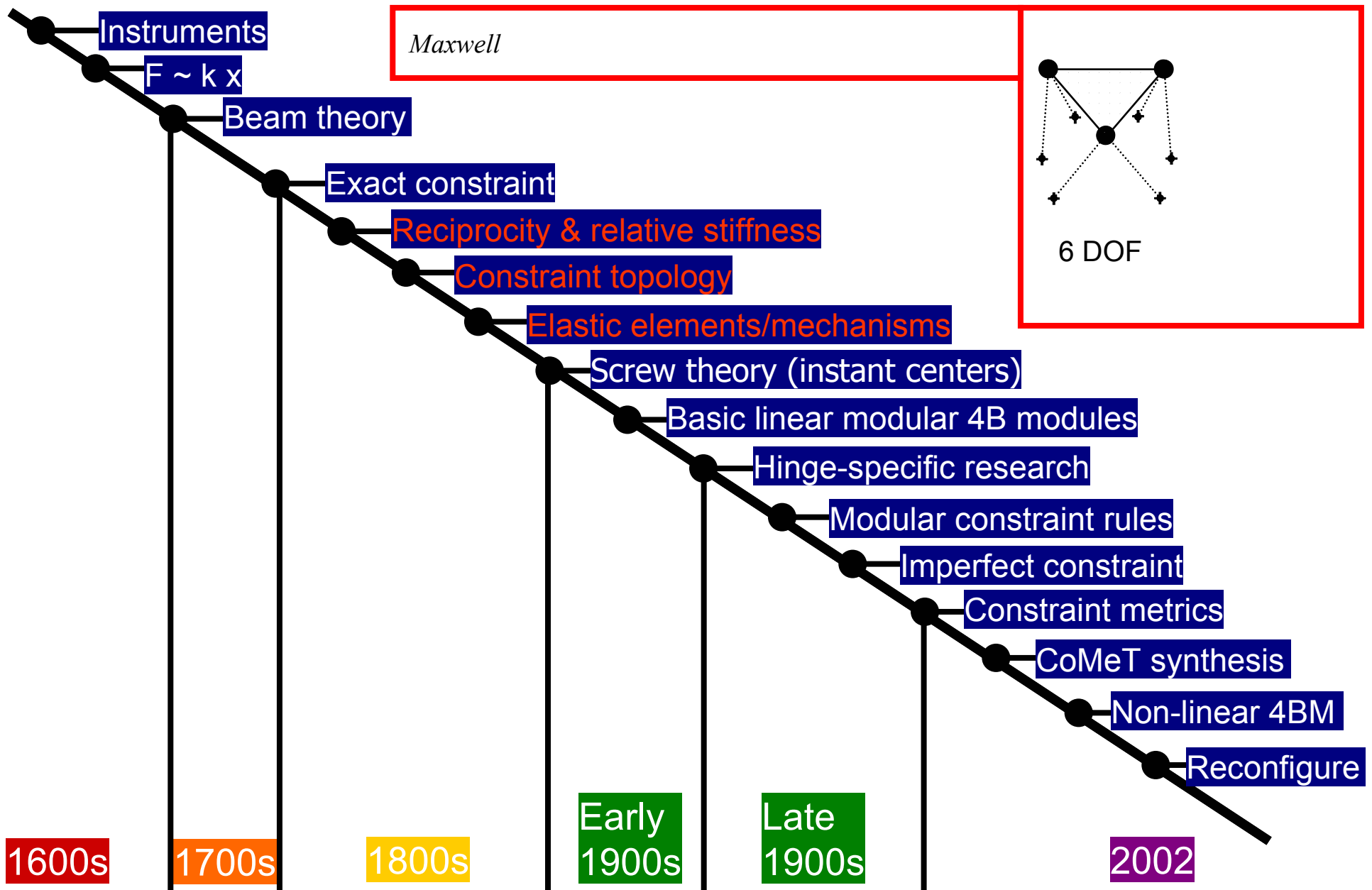

History of compliant machines

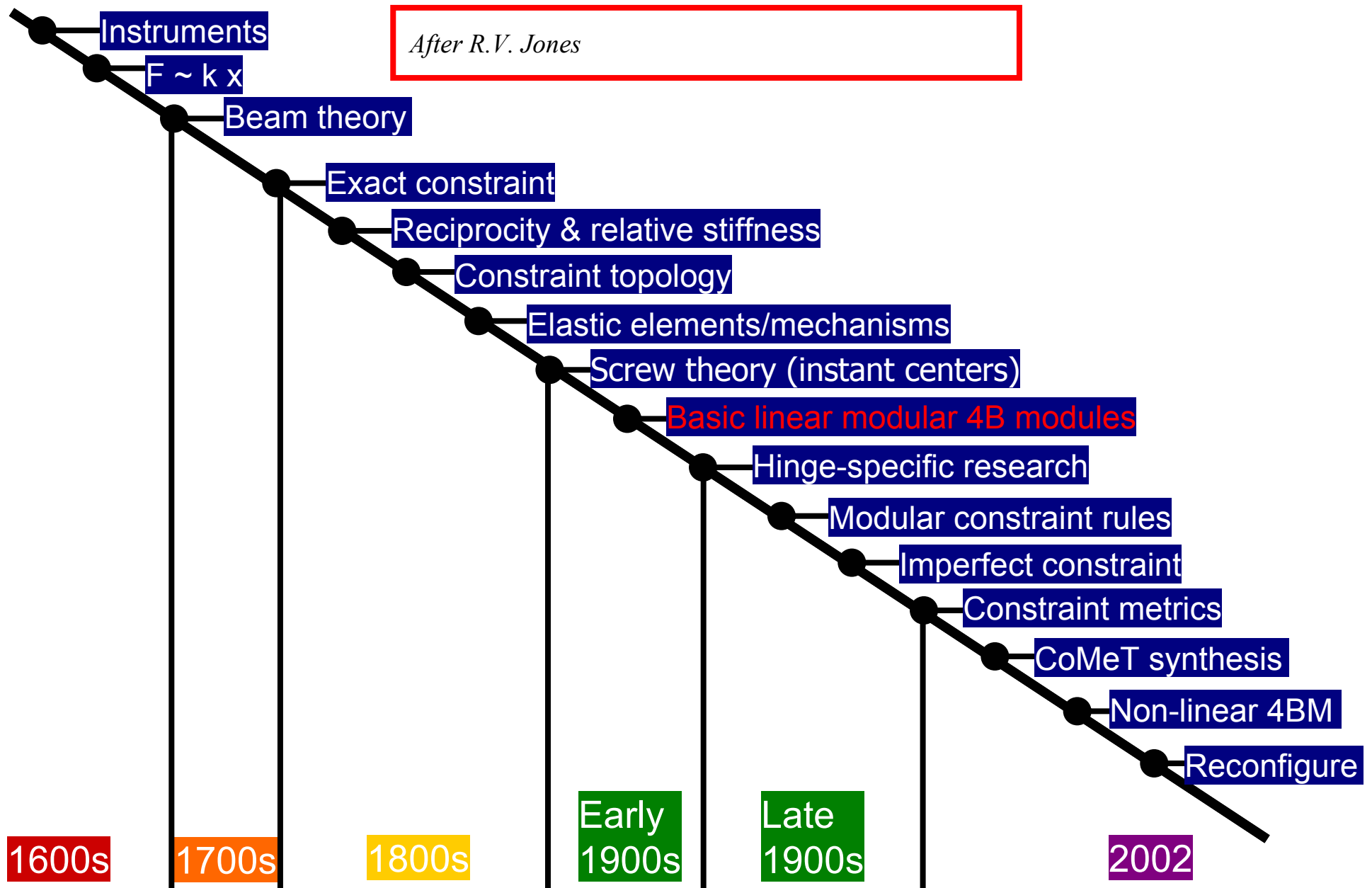

History of compliant machines

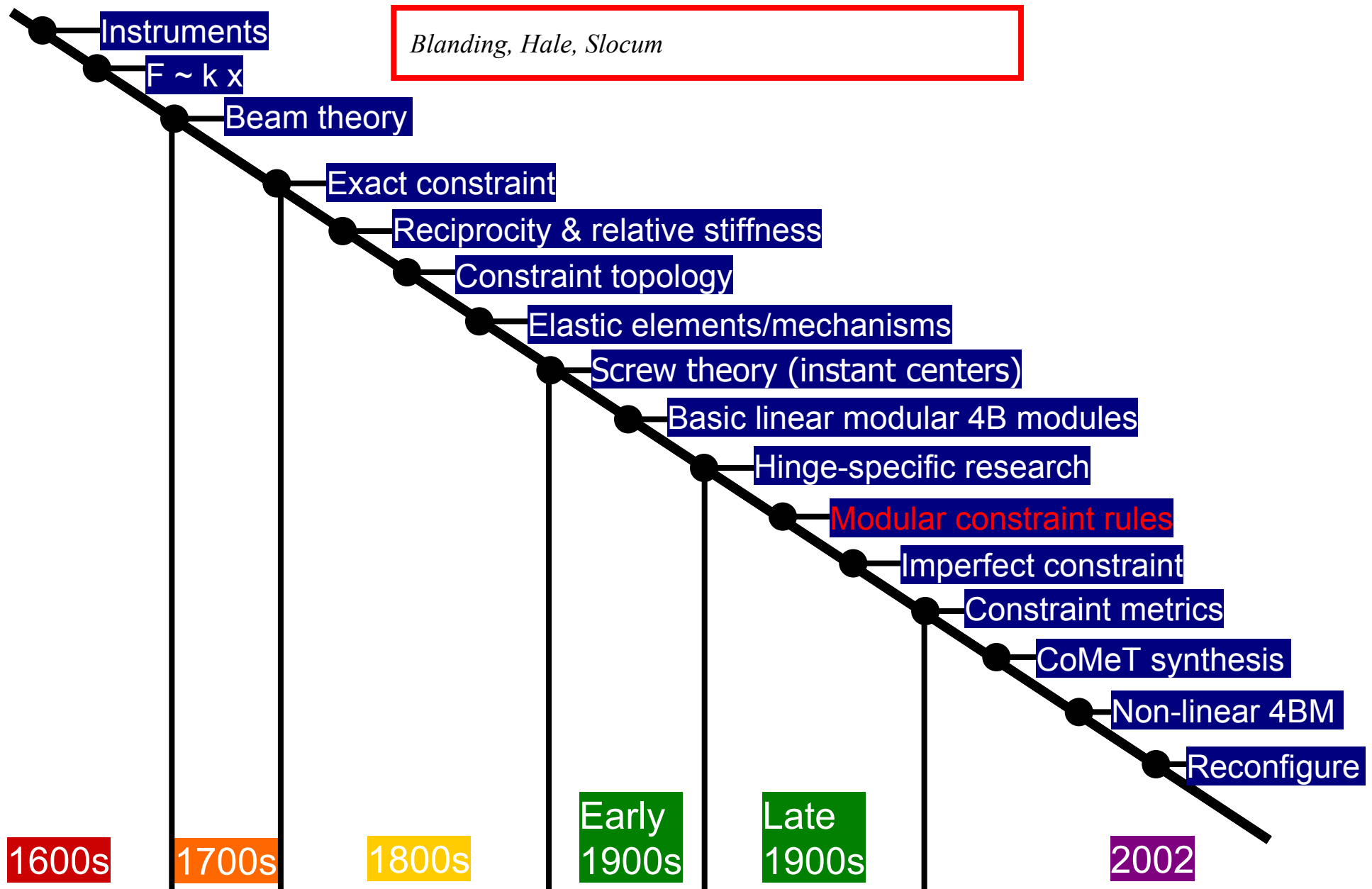

History of compliant machines

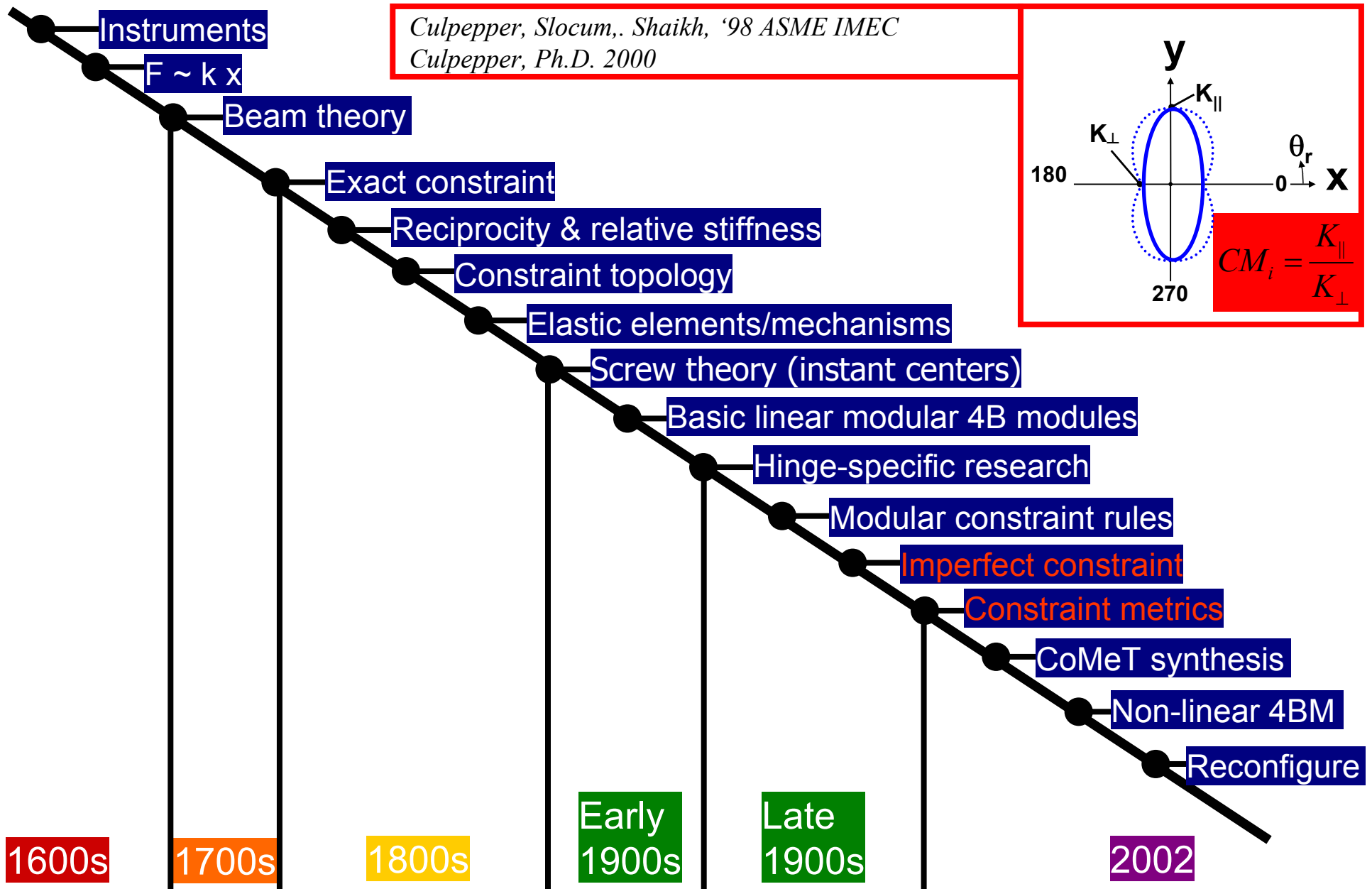

History of compliant machines

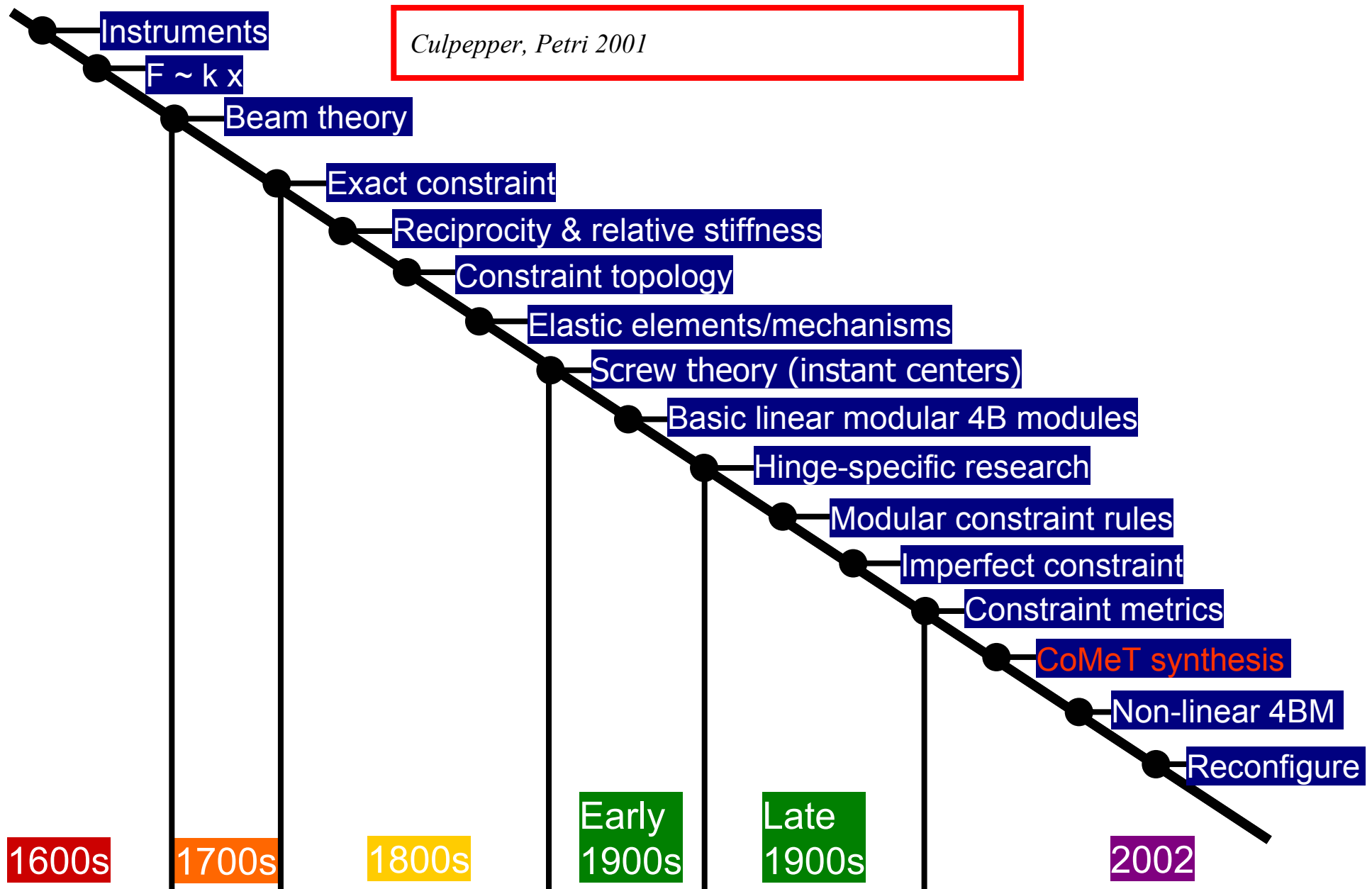

History of compliant machines

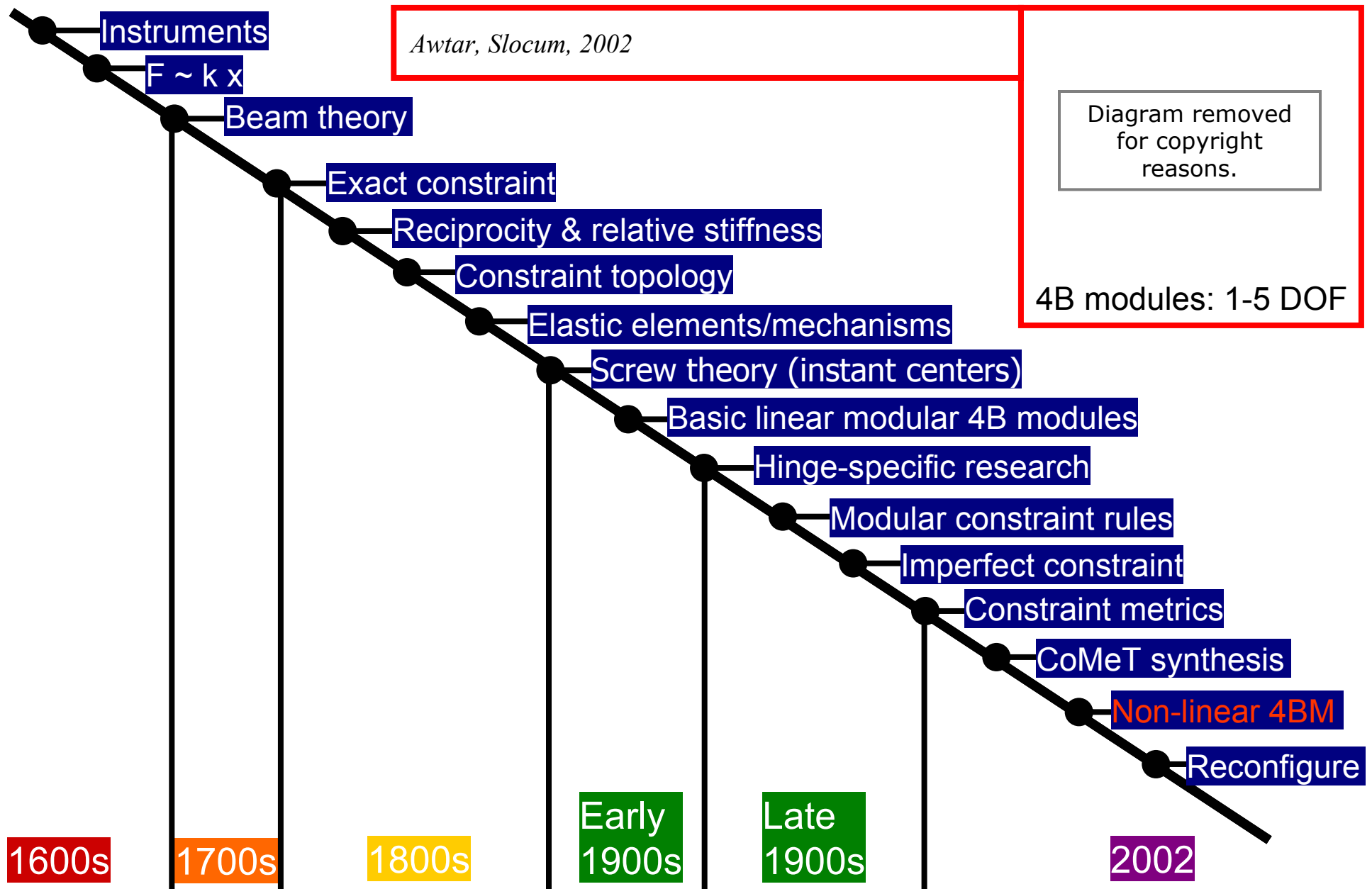

History of compliant machines

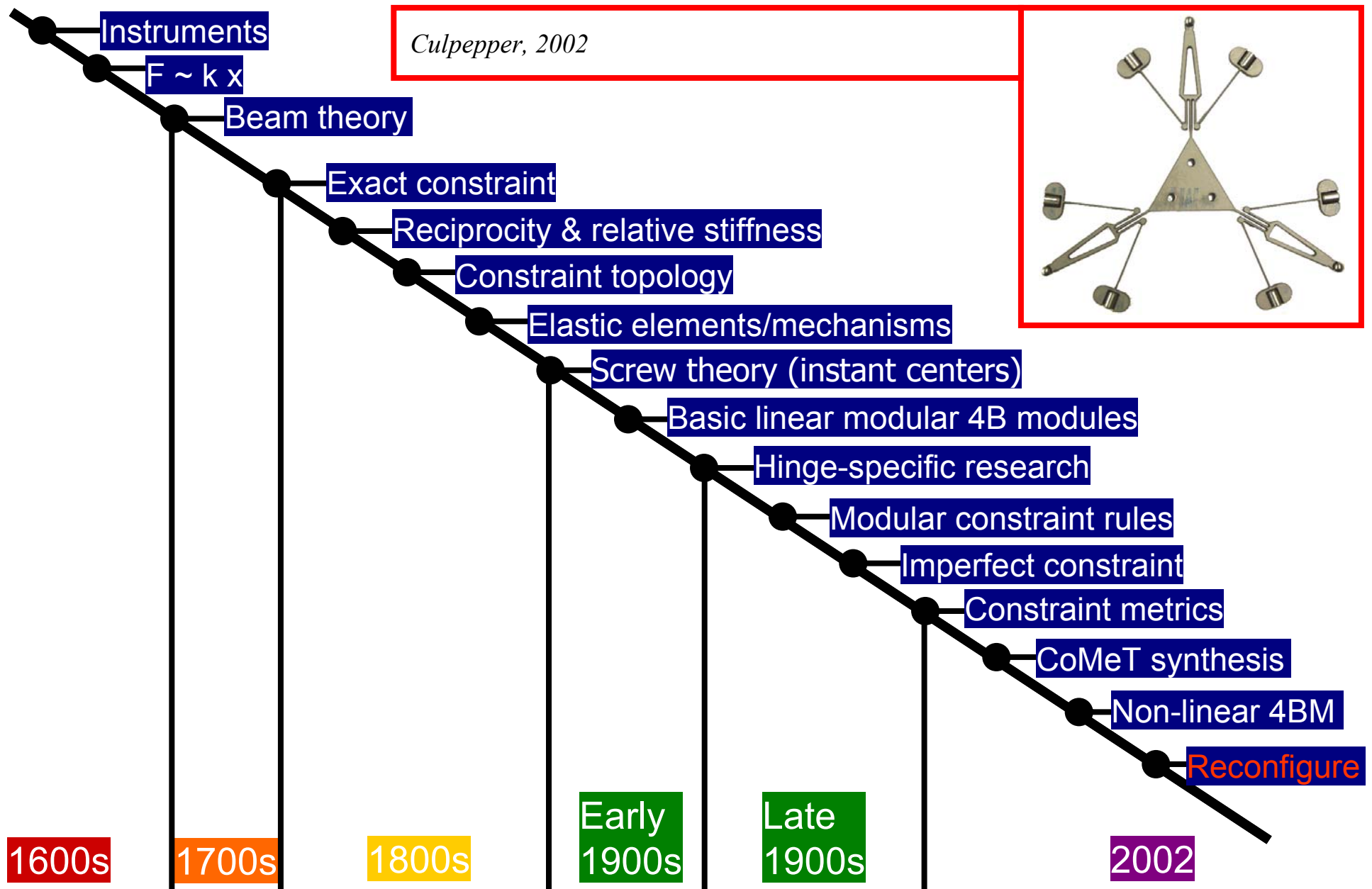

Principles of cross-scale motion and constraint

To flex or not to flex

Good

- ❑ Smooth, “hysteresis free” motion
- ❑ Symmetry easy to implement
- ❑ Linearity

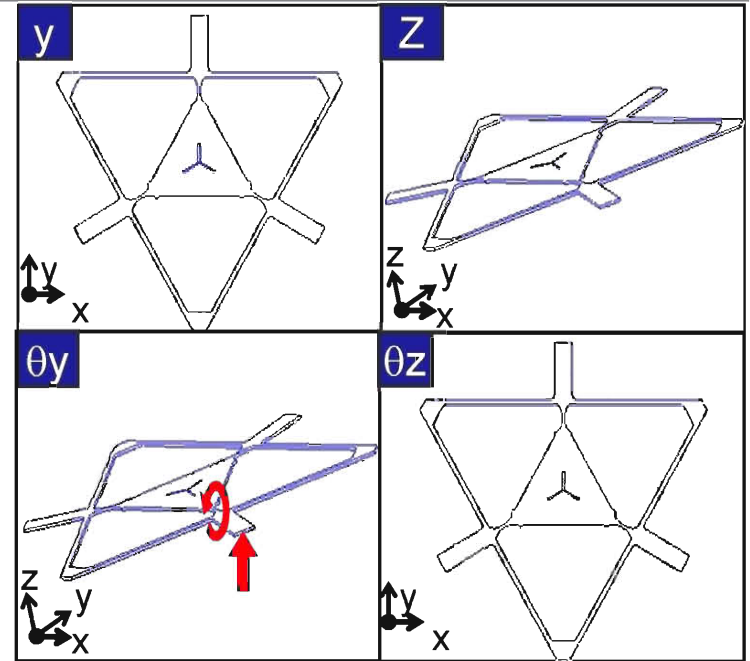

Unpleasant

- ❑ Accuracy and repeatability sensitive to several variables
- ❑ Limited motion/stroke (20% of yield unless single crystal Si)
- ❑ Stiffness ratio compared to other guide/bearing mechanisms is low

Design for compliant constraint

1. Stability

- Maximize passive stability
- “Self-help” (symmetry & cancellation)

2. Envelope

- Strain errors (compliance, thermal)
- Packaging

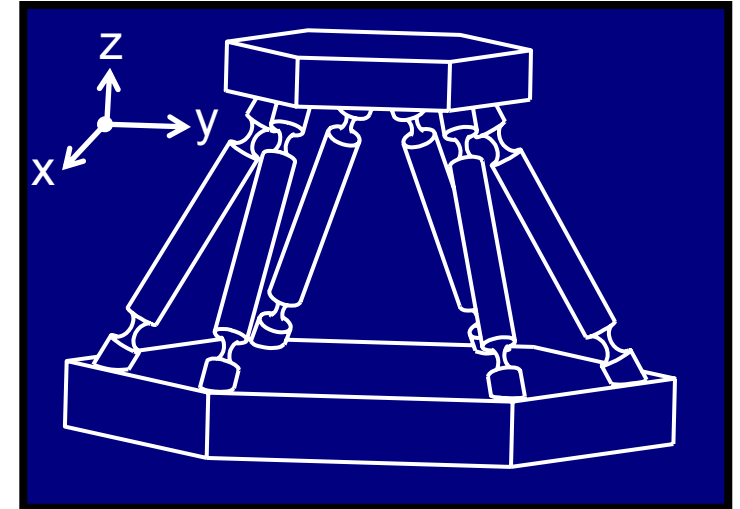

3. Manufacturing

- Monolithic
- Minimum information

4. Constraint

- Maximize linear independence
- Parasitic errors

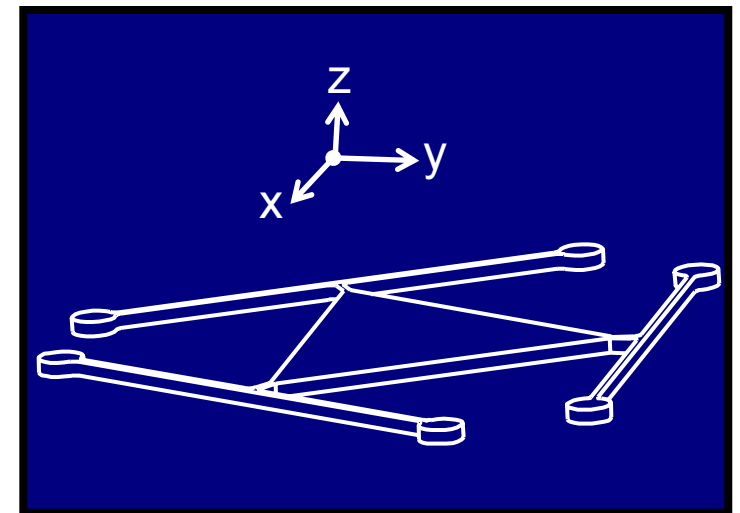

Parasitic errors

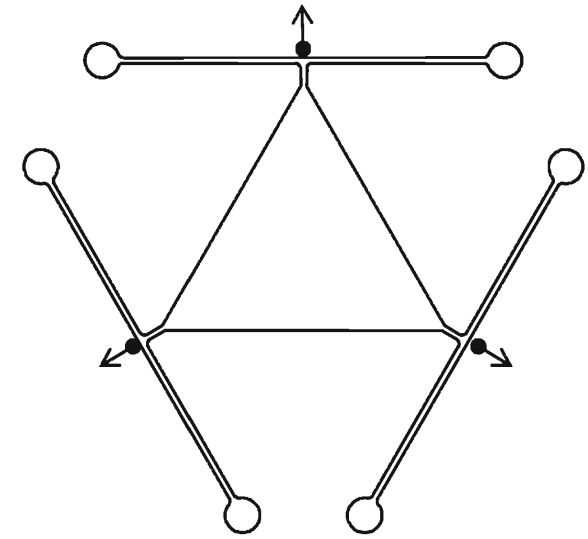
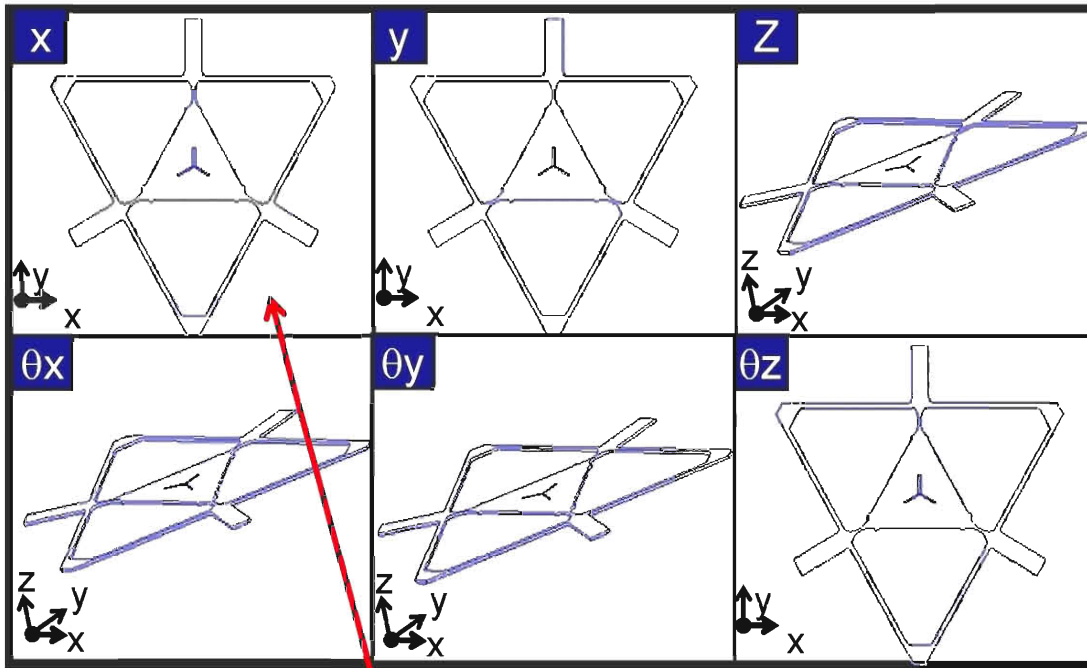

X axis positioning

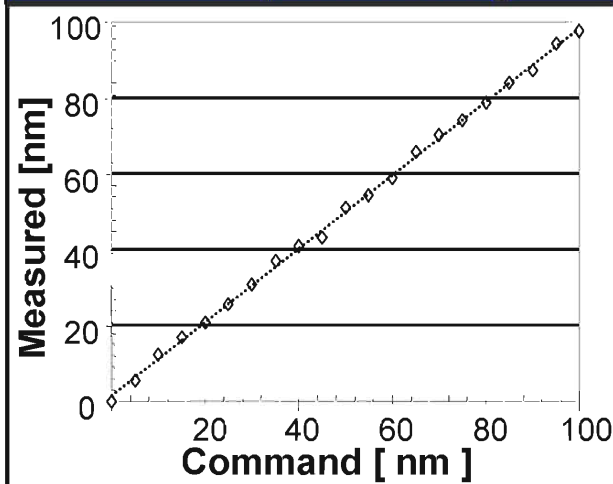

Parasitic errors [x move]

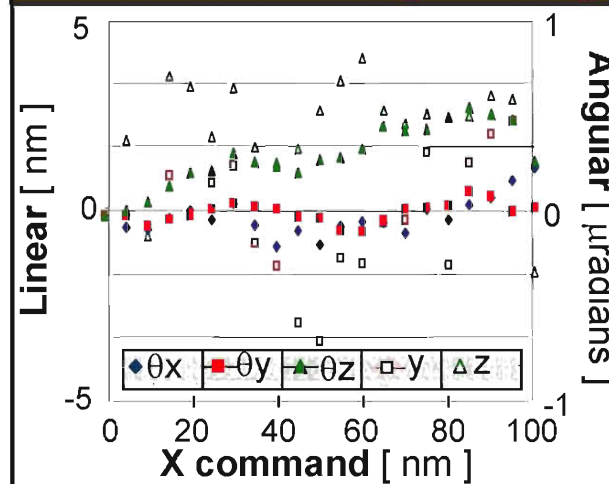

Principle of symmetry

Thermal strain error

Over constraint \rightarrow Force

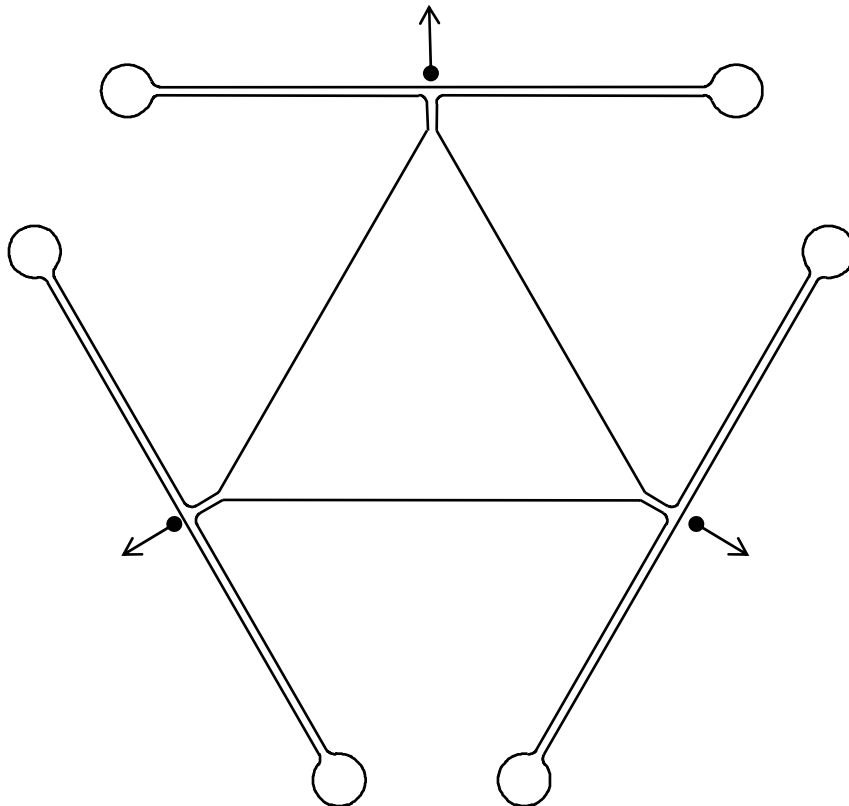

Start-up thermal drift

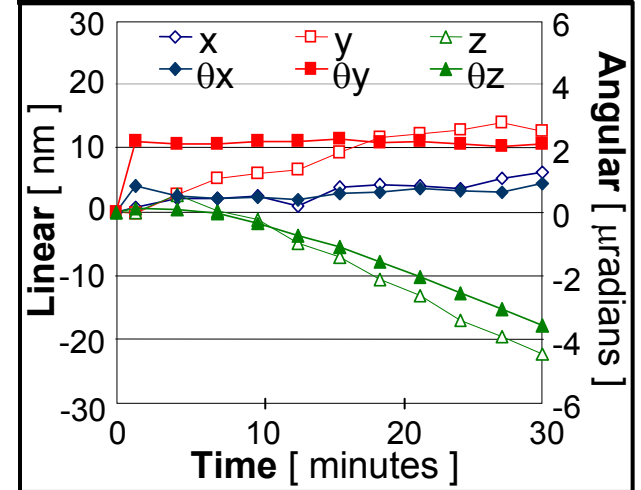

Principle of cancellation

Kinematic path building blocks

- Straight lines
- Rotation (instant centers)

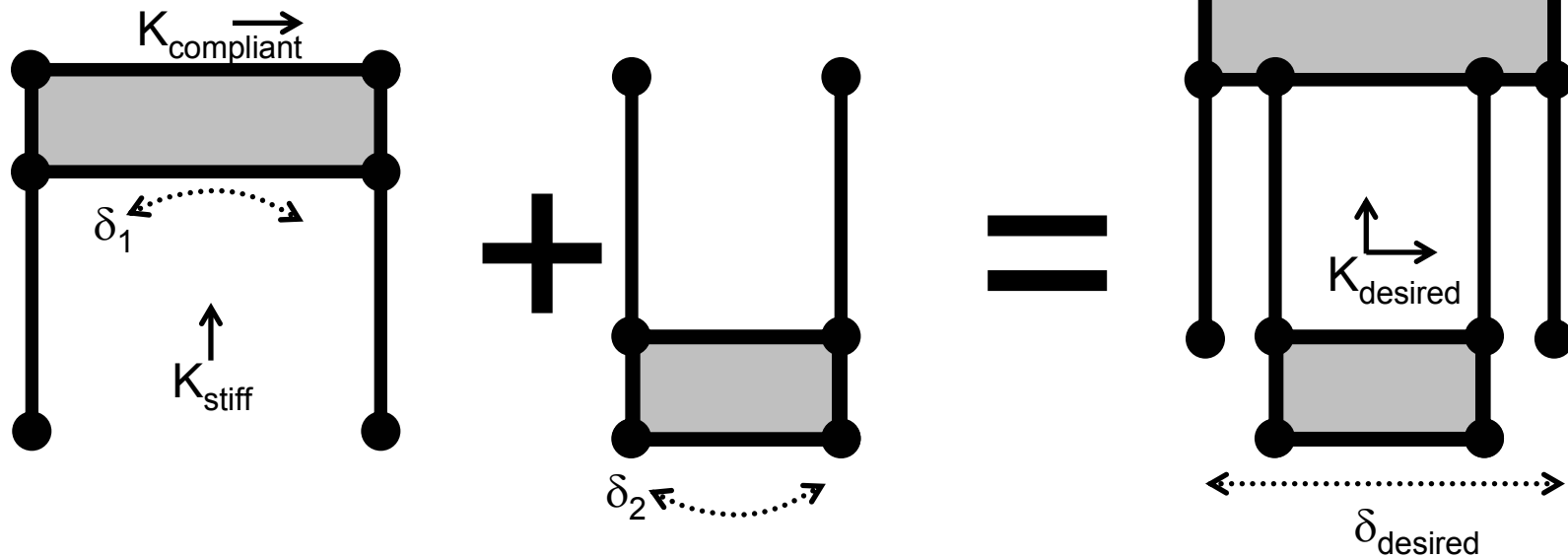

Principle of center of stiffness

Loading matters

Center of stiffness: Load = no rotation

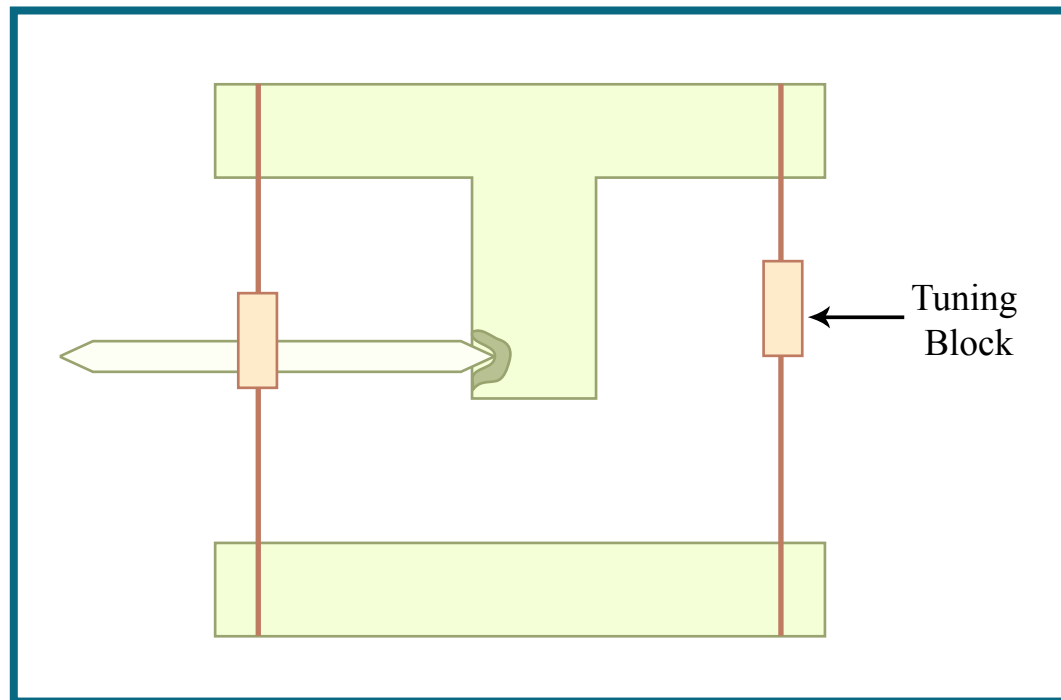

Figure by MIT OCW. After R. V. Jones.

Modeling

General Exact Constraint

$$\delta_{Stage} = A \cdot \Delta_{Actuator}$$

$$\begin{bmatrix} x \\ y \\ z \\ \theta_x \\ \theta_y \\ \theta_z \end{bmatrix} = \begin{bmatrix} E_{x1} & E_{x2} & E_{x3} & E_{x4} & E_{x5} & E_{x6} \\ E_{y1} & E_{y2} & E_{y3} & E_{y4} & E_{y5} & E_{y6} \\ E_{z1} & E_{z2} & E_{z3} & E_{z4} & E_{z5} & E_{z6} \\ E_{\theta x1} & E_{\theta x2} & E_{\theta x3} & E_{\theta x4} & E_{\theta x5} & E_{\theta x6} \\ E_{\theta y1} & E_{\theta y2} & E_{\theta y3} & E_{\theta y4} & E_{\theta y5} & E_{\theta y6} \\ E_{\theta z1} & E_{\theta z2} & E_{\theta z3} & E_{\theta z4} & E_{\theta z5} & E_{\theta z6} \end{bmatrix} \begin{bmatrix} \Delta_1 \\ \Delta_2 \\ \Delta_3 \\ \Delta_4 \\ \Delta_5 \\ \Delta_6 \end{bmatrix}$$

Nominal

$$\delta_{Stage} = N \cdot \Delta_{Actuator}$$

$$\begin{bmatrix} x \\ y \\ z \\ \theta_x \\ \theta_y \\ \theta_z \end{bmatrix} = \begin{bmatrix} N_{x1} & N_{x2} & N_{x3} & 0 & 0 & 0 \\ N_{y1} & N_{y2} & N_{y3} & 0 & 0 & 0 \\ 0 & 0 & 0 & N_{z4} & N_{z5} & N_{z6} \\ N_{\theta x1} & N_{\theta x2} & N_{\theta x3} & 0 & 0 & 0 \\ N_{\theta y1} & N_{\theta y2} & N_{\theta y3} & 0 & 0 & 0 \\ 0 & 0 & 0 & 0 & 0 & 0 \end{bmatrix} \begin{bmatrix} \Delta_1 \\ \Delta_2 \\ \Delta_3 \\ \Delta_4 \\ \Delta_5 \\ \Delta_6 \end{bmatrix}$$

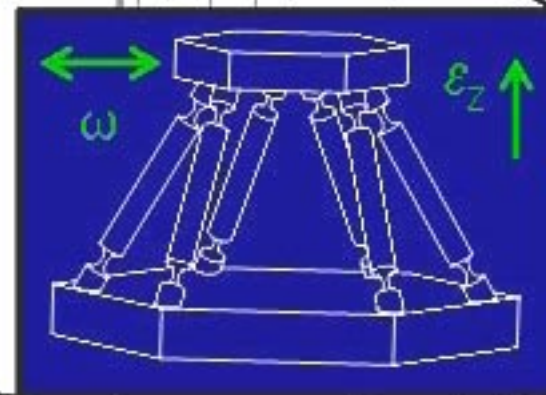

Non-Calibrated

$$\delta_{Stage} = U \cdot \Delta_{Actuator}$$

$$\begin{bmatrix} x \\ y \\ z \\ \theta_x \\ \theta_y \\ \theta_z \end{bmatrix} = \begin{bmatrix} U_{x1} & U_{x2} & U_{x3} & P_{x4} & P_{x5} & P_{x6} \\ U_{y1} & U_{y2} & U_{y3} & P_{y4} & P_{y5} & P_{y6} \\ P_{z1} & P_{z2} & P_{z3} & U_{z4} & U_{z5} & U_{z6} \\ P_{\theta x1} & P_{\theta x2} & P_{\theta x3} & U_{\theta x4} & U_{\theta x5} & U_{\theta x6} \\ P_{\theta y1} & P_{\theta y2} & P_{\theta y3} & U_{\theta y4} & U_{\theta y5} & U_{\theta y6} \\ U_{\theta z1} & U_{\theta z2} & U_{\theta z3} & P_{\theta z4} & P_{\theta z5} & P_{\theta z6} \end{bmatrix} \begin{bmatrix} \Delta_1 \\ \Delta_2 \\ \Delta_3 \\ \Delta_4 \\ \Delta_5 \\ \Delta_6 \end{bmatrix}$$

Calibrated

$$\delta_{Stage} = C \cdot \Delta_{Actuator}$$

$$\begin{bmatrix} x \\ y \\ z \\ \theta_x \\ \theta_y \\ \theta_z \end{bmatrix} = \begin{bmatrix} C_{x1} & C_{x2} & C_{x3} & 0 & 0 & 0 \\ C_{y1} & C_{y2} & C_{y3} & 0 & 0 & 0 \\ 0 & 0 & 0 & C_{z4} & C_{z5} & C_{z6} \\ 0 & 0 & 0 & C_{\theta x4} & C_{\theta x5} & C_{\theta x6} \\ 0 & 0 & 0 & C_{\theta y4} & C_{\theta y5} & C_{\theta y6} \\ C_{\theta z1} & C_{\theta z2} & C_{\theta z3} & 0 & 0 & 0 \end{bmatrix} \begin{bmatrix} \Delta_1 \\ \Delta_2 \\ \Delta_3 \\ \Delta_4 \\ \Delta_5 \\ \Delta_6 \end{bmatrix}$$

Modeling

General Exact Constraint

$$\delta_{Stage} = A \Delta_{Actuator}$$

x	E_{x1}	E_{x2}	E_{x3}	E_{x4}	E_{x5}	E_{x6}	Δ_1
y	E_{y1}	E_{y2}	E_{y3}	E_{y4}	E_{y5}	E_{y6}	Δ_2
z	E_{z1}	E_{z2}	E_{z3}	E_{z4}	E_{z5}	E_{z6}	Δ_3
θ_x	$E_{\theta x1}$	$E_{\theta x2}$	$E_{\theta x3}$	$E_{\theta x4}$	$E_{\theta x5}$	$E_{\theta x6}$	Δ_4
θ_y	$E_{\theta y1}$	$E_{\theta y2}$	$E_{\theta y3}$	$E_{\theta y4}$	$E_{\theta y5}$	$E_{\theta y6}$	Δ_5
θ_z	$E_{\theta z1}$	$E_{\theta z2}$	$E_{\theta z3}$	$E_{\theta z4}$	$E_{\theta z5}$	$E_{\theta z6}$	Δ_6

Nominal

$$\delta_{Stage} = N \cdot \Delta_{Actuator}$$

x	N_{x1}	N_{x2}	N_{x3}	0	0	0	Δ_1
y	N_{y1}	N_{y2}	N_{y3}	0	0	0	Δ_2
z	0	0	0	N_{z4}	N_{z5}	N_{z6}	Δ_3
θ_x	0	0	0	$N_{\theta x4}$	$N_{\theta x5}$	$N_{\theta x6}$	Δ_4
θ_y	0	0	0	$N_{\theta y4}$	$N_{\theta y5}$	$N_{\theta y6}$	Δ_5
θ_z	$N_{\theta z1}$	$N_{\theta z2}$	$N_{\theta z3}$	0	0	0	Δ_6

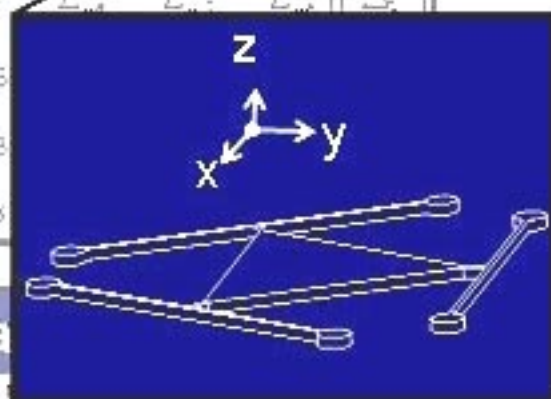

Non-Calibrated

$$\delta_{Stage} = C \Delta_{Actuator}$$

x	U_{x1}	U_{x2}	U_{x3}	P_{x4}	P_{x5}	P_{x6}	Δ_1
y	U_{y1}	U_{y2}	U_{y3}	P_{y4}	P_{y5}	P_{y6}	Δ_2
z	P_{z1}	P_{z2}	P_{z3}	U_{z4}	U_{z5}	U_{z6}	Δ_3
θ_x	$P_{\theta x1}$	$P_{\theta x2}$	$P_{\theta x3}$	$U_{\theta x4}$	$U_{\theta x5}$	$U_{\theta x6}$	Δ_4
θ_y	$P_{\theta y1}$	$P_{\theta y2}$	$P_{\theta y3}$	$U_{\theta y4}$	$U_{\theta y5}$	$U_{\theta y6}$	Δ_5
θ_z	$U_{\theta z1}$	$U_{\theta z2}$	$U_{\theta z3}$	$P_{\theta z4}$	$P_{\theta z5}$	$P_{\theta z6}$	Δ_6

"Perfectly" Calibrated

$$\delta_{Stage} = C \cdot \Delta_{Actuator}$$

x	C_{x1}	C_{x2}	C_{x3}	0	0	0	Δ_1
y	C_{y1}	C_{y2}	C_{y3}	0	0	0	Δ_2
z	0	0	0	C_{z4}	C_{z5}	C_{z6}	Δ_3
θ_x	0	0	0	$C_{\theta x4}$	$C_{\theta x5}$	$C_{\theta x6}$	Δ_4
θ_y	0	0	0	$C_{\theta y4}$	$C_{\theta y5}$	$C_{\theta y6}$	Δ_5
θ_z	$C_{\theta z1}$	$C_{\theta z2}$	$C_{\theta z3}$	0	0	0	Δ_6

Modeling

General Exact Constraint

$$\delta_{Stage} = A \cdot \Delta_{Actuator}$$

x	E_{x1}	E_{x2}	E_{x3}	E_{x4}	E_{x5}	E_{x6}	Δ_1
y	E_{y1}	E_{y2}	E_{y3}	E_{y4}	E_{y5}	E_{y6}	Δ_2
z	E_{z1}	E_{z2}	E_{z3}	E_{z4}	E_{z5}	E_{z6}	Δ_3
θ_x	$E_{\theta x1}$	$E_{\theta x2}$	$E_{\theta x3}$	$E_{\theta x4}$	$E_{\theta x5}$	$E_{\theta x6}$	Δ_4
θ_y	$E_{\theta y1}$	$E_{\theta y2}$	$E_{\theta y3}$	$E_{\theta y4}$	$E_{\theta y5}$	$E_{\theta y6}$	Δ_5
θ_z	$E_{\theta z1}$	$E_{\theta z2}$	$E_{\theta z3}$	$E_{\theta z4}$	$E_{\theta z5}$	$E_{\theta z6}$	Δ_6

Nominal

$$\delta_{Stage} = N \cdot \Delta_{Actuator}$$

x	N_{x1}	N_{x2}	N_{x3}	0	0	0	Δ_1
y	N_{y1}	N_{y2}	N_{y3}	0	0	0	Δ_2
z	0	0	0	N_{z4}	N_{z5}	N_{z6}	Δ_3
θ_x	0	0	0	$N_{\theta x4}$	$N_{\theta x5}$	$N_{\theta x6}$	Δ_4
θ_y	0	0	0	$N_{\theta y4}$	$N_{\theta y5}$	$N_{\theta y6}$	Δ_5
θ_z	$N_{\theta z1}$	$N_{\theta z2}$	$N_{\theta z3}$	0	0	0	Δ_6

Non-Calibrated

$$\delta_{Stage} = U \cdot \Delta_{Actuator}$$

x	U_{x1}	U_{x2}	U_{x3}	P_{x4}	P_{x5}	P_{x6}	Δ_1
y	U_{y1}	U_{y2}	U_{y3}	P_{y4}	P_{y5}	P_{y6}	Δ_2
z	P_{z1}	P_{z2}	P_{z3}	U_{z4}	U_{z5}	U_{z6}	Δ_3
θ_x	$P_{\theta x1}$	$P_{\theta x2}$	$P_{\theta x3}$	$U_{\theta x4}$	$U_{\theta x5}$	$U_{\theta x6}$	Δ_4
θ_y	$P_{\theta y1}$	$P_{\theta y2}$	$P_{\theta y3}$	$U_{\theta y4}$	$U_{\theta y5}$	$U_{\theta y6}$	Δ_5
θ_z	$U_{\theta z1}$	$U_{\theta z2}$	$U_{\theta z3}$	$P_{\theta z4}$	$P_{\theta z5}$	$P_{\theta z6}$	Δ_6

"Perfectly" Calibrated

$$\delta_{Stage} = C \cdot \Delta_{Actuator}$$

x	C_{x1}	C_{x2}	C_{x3}	0	0	0	Δ_1
y	C_{y1}	C_{y2}	C_{y3}	0	0	0	Δ_2
z	0	0	0	C_{z4}	C_{z5}	C_{z6}	Δ_3
θ_x	0	0	0	$C_{\theta x4}$	$C_{\theta x5}$	$C_{\theta x6}$	Δ_4
θ_y	0	0	0	$C_{\theta y4}$	$C_{\theta y5}$	$C_{\theta y6}$	Δ_5
θ_z	$C_{\theta z1}$	$C_{\theta z2}$	$C_{\theta z3}$	0	0	0	Δ_6

Modeling

General Exact Constraint

$$\delta_{Stage} = A \cdot \Delta_{Actuator}$$

x	E_{x1}	E_{x2}	E_{x3}	E_{x4}	E_{x5}	E_{x6}	Δ_1
y	E_{y1}	E_{y2}	E_{y3}	E_{y4}	E_{y5}	E_{y6}	Δ_2
z	E_{z1}	E_{z2}	E_{z3}	E_{z4}	E_{z5}	E_{z6}	Δ_3
θ_x	$E_{\theta x1}$	$E_{\theta x2}$	$E_{\theta x3}$	$E_{\theta x4}$	$E_{\theta x5}$	$E_{\theta x6}$	Δ_4
θ_y	$E_{\theta y1}$	$E_{\theta y2}$	$E_{\theta y3}$	$E_{\theta y4}$	$E_{\theta y5}$	$E_{\theta y6}$	Δ_5
θ_z	$E_{\theta z1}$	$E_{\theta z2}$	$E_{\theta z3}$	$E_{\theta z4}$	$E_{\theta z5}$	$E_{\theta z6}$	Δ_6

Nominal

$$\delta_{Stage} = N \cdot \Delta_{Actuator}$$

x	N_{x1}	N_{x2}	N_{x3}	0	0	0	Δ_1
y	N_{y1}	N_{y2}	N_{y3}	0	0	0	Δ_2
z	0	0	0	N_{z4}	N_{z5}	N_{z6}	Δ_3
θ_x	0	0	0	$N_{\theta x4}$	$N_{\theta x5}$	$N_{\theta x6}$	Δ_4
θ_y	0	0	0	$N_{\theta y4}$	$N_{\theta y5}$	$N_{\theta y6}$	Δ_5
θ_z	$N_{\theta z1}$	$N_{\theta z2}$	$N_{\theta z3}$	0	0	0	Δ_6

Non-Calibrated

$$\delta_{Stage} = U \cdot \Delta_{Actuator}$$

x	U_{x1}	U_{x2}	U_{x3}	P_{x4}	P_{x5}	P_{x6}	Δ_1
y	U_{y1}	U_{y2}	U_{y3}	P_{y4}	P_{y5}	P_{y6}	Δ_2
z	P_{z1}	P_{z2}	P_{z3}	U_{z4}	U_{z5}	U_{z6}	Δ_3
θ_x	$P_{\theta x1}$	$P_{\theta x2}$	$P_{\theta x3}$	$U_{\theta x4}$	$U_{\theta x5}$	$U_{\theta x6}$	Δ_4
θ_y	$P_{\theta y1}$	$P_{\theta y2}$	$P_{\theta y3}$	$U_{\theta y4}$	$U_{\theta y5}$	$U_{\theta y6}$	Δ_5
θ_z	$U_{\theta z1}$	$U_{\theta z2}$	$U_{\theta z3}$	$P_{\theta z4}$	$P_{\theta z5}$	$P_{\theta z6}$	Δ_6

"Perfectly" Calibrated

$$\delta_{Stage} = C \cdot \Delta_{Actuator}$$

x	C_{x1}	C_{x2}	C_{x3}	0	0	0	Δ_1
y	C_{y1}	C_{y2}	C_{y3}	0	0	0	Δ_2
z	0	0	0	C_{z4}	C_{z5}	C_{z6}	Δ_3
θ_x	0	0	0	$C_{\theta x4}$	$C_{\theta x5}$	$C_{\theta x6}$	Δ_4
θ_y	0	0	0	$C_{\theta y4}$	$C_{\theta y5}$	$C_{\theta y6}$	Δ_5
θ_z	$C_{\theta z1}$	$C_{\theta z2}$	$C_{\theta z3}$	0	0	0	Δ_6



Actuator sensitivity & calibration

Source of errors

- Tolerance (5000 nm vs 1nm?)
- Mounting
- Material props
- Stress stiffening
- Linear assumptions

- Calibration and mapping...

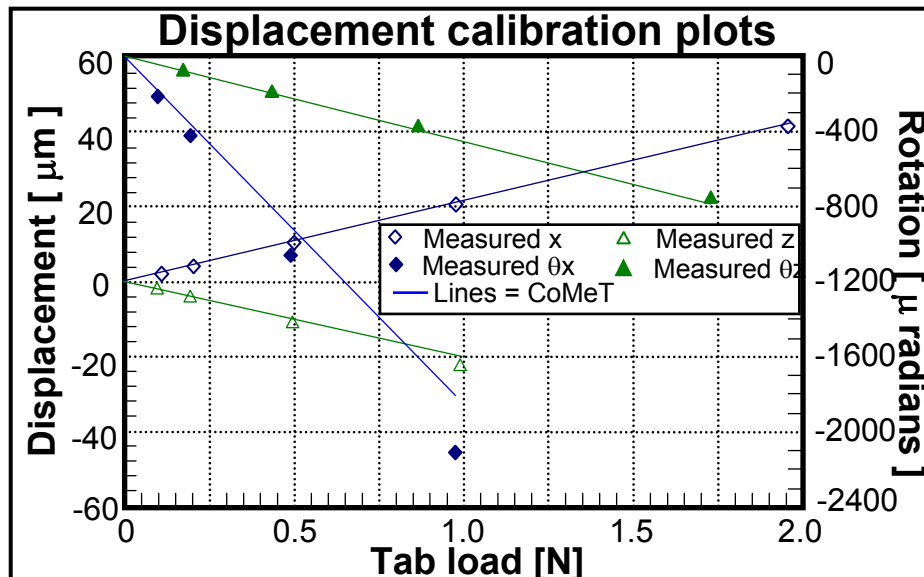

“Perfectly” Calibrated

$$\delta_{Stage} = C \cdot \Delta_{Actuator}$$

x	C_{x1}	C_{x2}	C_{x3}	0	0	0	Δ_1
y	C_{y1}	C_{y2}	C_{y3}	0	0	0	Δ_2
z	0	0	0	C_{z4}	C_{z5}	C_{z6}	Δ_3
θ_x	0	0	0	$C_{\theta x4}$	$C_{\theta x5}$	$C_{\theta x6}$	Δ_4
θ_y	0	0	0	$C_{\theta y4}$	$C_{\theta y5}$	$C_{\theta y6}$	Δ_5
θ_z	$C_{\theta z1}$	$C_{\theta z2}$	$C_{\theta z3}$	0	0	0	Δ_6

Constraint-based compliant mechanism design

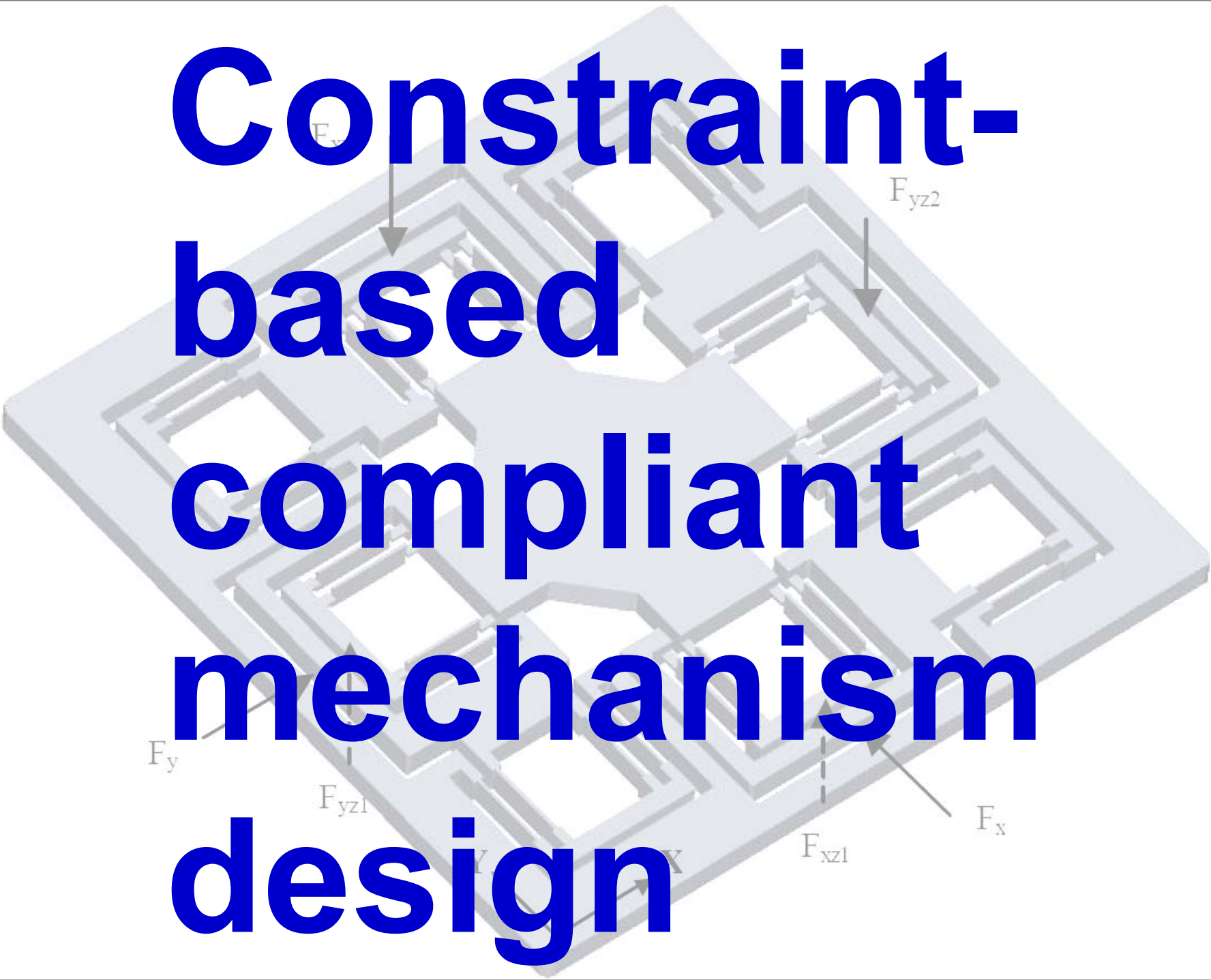

Constraint-based CM design

Compliant mechanism design methods

Pseudo-rigid body (lumped compliance)	Continuum /topology (distributed compliance)	Constraint-based (modular kinematic concepts)
↓	↓	↓
<ul style="list-style-type: none"> • Combinations of rigid and compliant elements • Compliant elements function and are modeled as hinges 	<ul style="list-style-type: none"> • Continuum-topology generation • Topology optimization 	<ul style="list-style-type: none"> • Modular concepts combined according to rational constraint & motion rules/constraint metrics • Constraint and displacement rules generate parametric concepts, optimization finalizes design

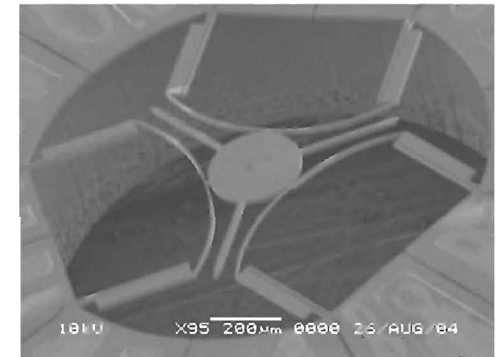
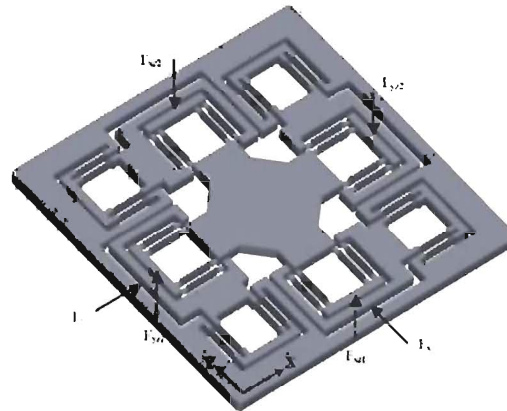
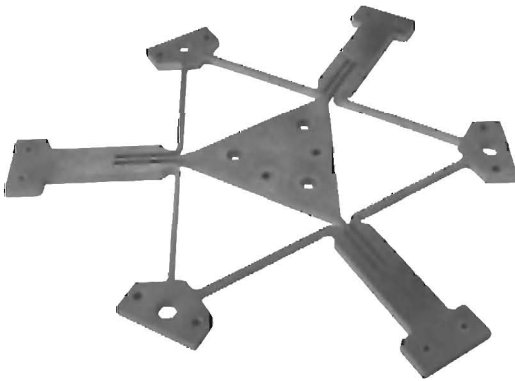
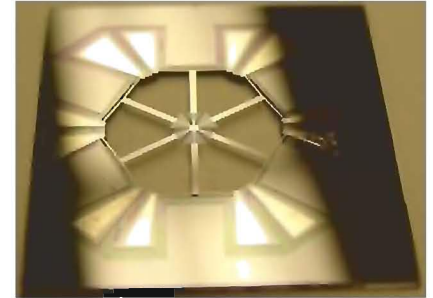

Constraint-based method

This is a rational process

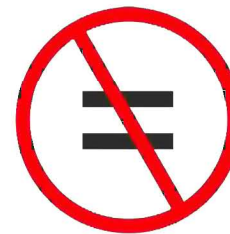

Intuition

Rules of constraint

DOC = # of linearly independent constraints

DOF = 6 - DOC

Constraints have lines of action

Lines of action intersect at instant centers

Instant centers (via constraint) define motion

Basic elements

Diagrams removed for copyright reasons.

Source: Blanding, D. L. *Exact Constraint: Machine Design using Kinematic Principles*. New York: ASME Press, 1999. ISBN: 0791800857

Bars

Beams

Plates

Cross Beam Hinge

Notch Hinge

Common precision constraint types

Constraints

□ 5 DOF

Diagrams removed for copyright reasons.

Source: Blanding, D. L. *Exact Constraint: Machine Design using Kinematic Principles*. New York: ASME Press, 1999. ISBN: 0791800857

□ 3 planar DOF

Constraint and Freedom

When connecting in series

□ Add degrees of freedom with exception of redundant degrees

□ Examples:

Rod at end of plate

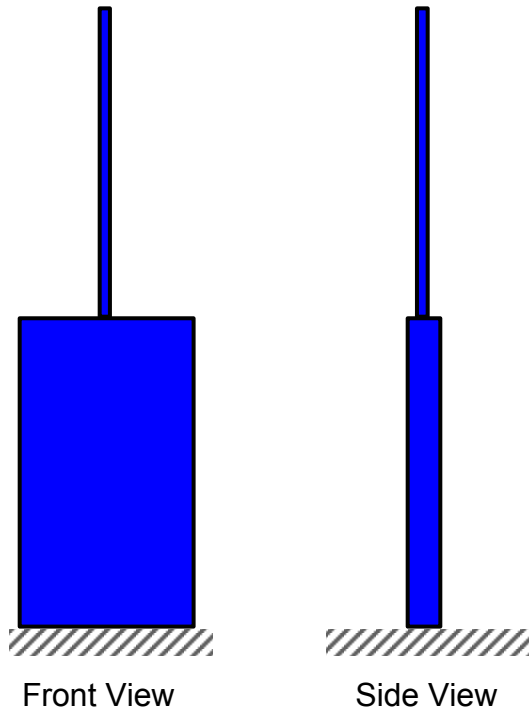

&

Rod on Rod

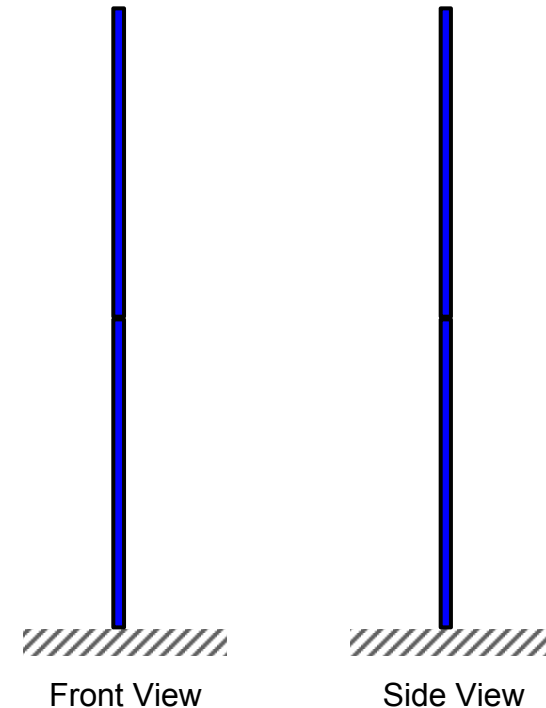

Constraint and freedom

When connecting in parallel

- Add constraints
- Example: Two sheets @ 90 degrees

Two Bars

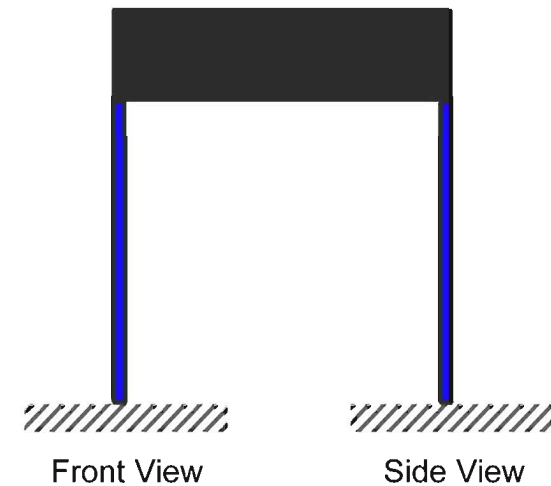
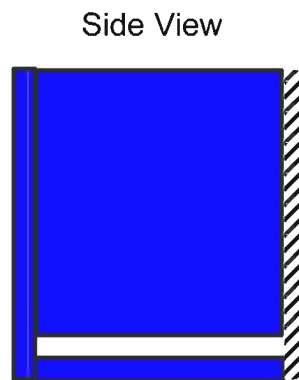
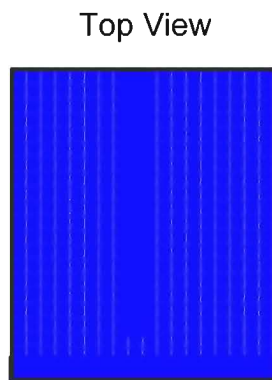

Example: Constraint-based design

Constraint-based compliant mechanism design

STEP 1: Design requirements

Motion path, stiffness, load capacity, etc...

STEP 2: Motion path decomposition

Arcs, lines, rotation pts. sub-paths

STEP 3: Kinematic parametric concepts

Motions, constraint metric, symmetry, etc.

STEP 4: Constraint-motion addition rules

Serial, parallel, hybrid

STEP 5: Topology concept generation

Path & constraint driven

STEP 6: Concept selection phase I

Path errors & over constraint

STEP 7: Size and shape optimization

Stiffness, load capacity, efficiency, etc...

STEP 8: Concept selection phase II

Direct comparison with design requirements

Diagram of automobile steering column, rack and rotor - removed for copyright reasons.



Example: Constraint-based design

Constraint-based compliant mechanism design

STEP 1: Design requirements

Motion path, stiffness, load capacity, etc...

STEP 2: Motion path decomposition

Arcs, lines, rotation pts. sub-paths

STEP 3: Kinematic parametric concepts

Motions, constraint metric, symmetry, etc.

STEP 4: Constraint-motion addition rules

Serial, parallel, hybrid

STEP 5: Topology concept generation

Path & constraint driven

STEP 6: Concept selection phase I

Path errors & over constraint

STEP 7: Size and shape optimization

Stiffness, load capacity, efficiency, etc...

STEP 8: Concept selection phase II

Direct comparison with design requirements

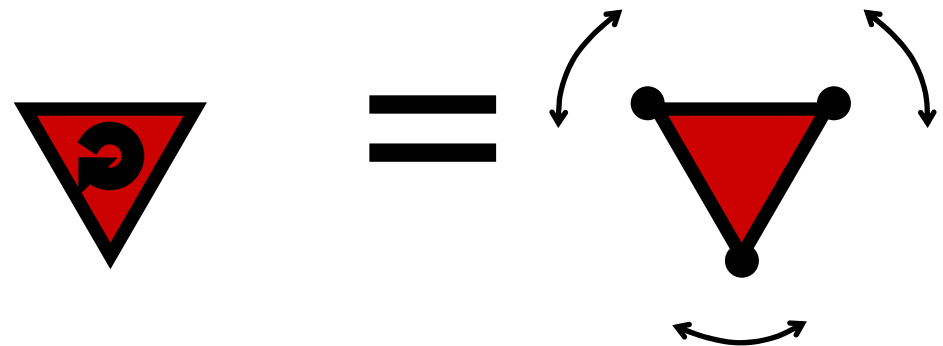

Example: Constraint-based design

Constraint-based compliant mechanism design

STEP 1: Design requirements

Motion path, stiffness, load capacity, etc...

STEP 2: Motion path decomposition

Arcs, lines, rotation pts. sub-paths

STEP 3: Kinematic parametric concepts

Motions, constraint metric, symmetry, etc.

STEP 4: Constraint-motion addition rules

Serial, parallel, hybrid

STEP 5: Topology concept generation

Path & constraint driven

STEP 6: Concept selection phase I

Path errors & over constraint

STEP 7: Size and shape optimization

Stiffness, load capacity, efficiency, etc...

STEP 8: Concept selection phase II

Direct comparison with design requirements

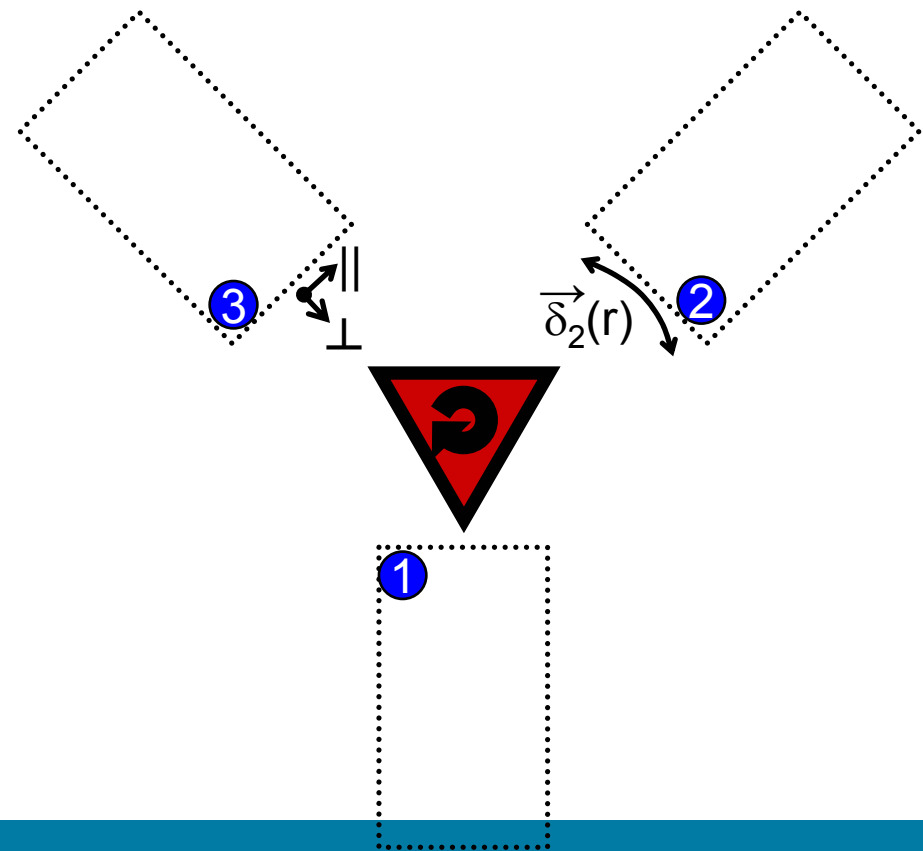
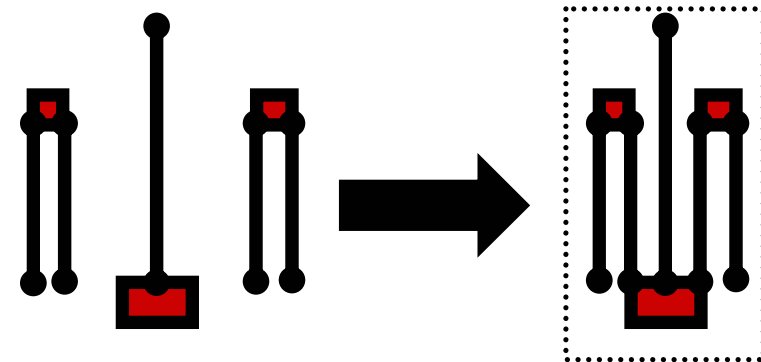

Example: Constraint-based design

Constraint-based compliant mechanism design

STEP 1: Design requirements

Motion path, stiffness, load capacity, etc...

STEP 2: Motion path decomposition

Arcs, lines, rotation pts. sub-paths

STEP 3: Kinematic parametric concepts

Motions, constraint metric, symmetry, etc.

STEP 4: Constraint-motion addition rules

Serial, parallel, hybrid

STEP 5: Topology concept generation

Path & constraint driven

STEP 6: Concept selection phase I

Path errors & over constraint

STEP 7: Size and shape optimization

Stiffness, load capacity, efficiency, etc...

STEP 8: Concept selection phase II

Direct comparison with design requirements

1. Series topology: Add DOF

2. Parallel topology: Add Constraints

3. Over constraint: $\frac{K_{\parallel}}{K_{\perp}} \cdot \frac{\delta_{\perp}}{\delta_{\parallel}} \rightarrow CM_k \cdot CM_{\delta} \ll 1$

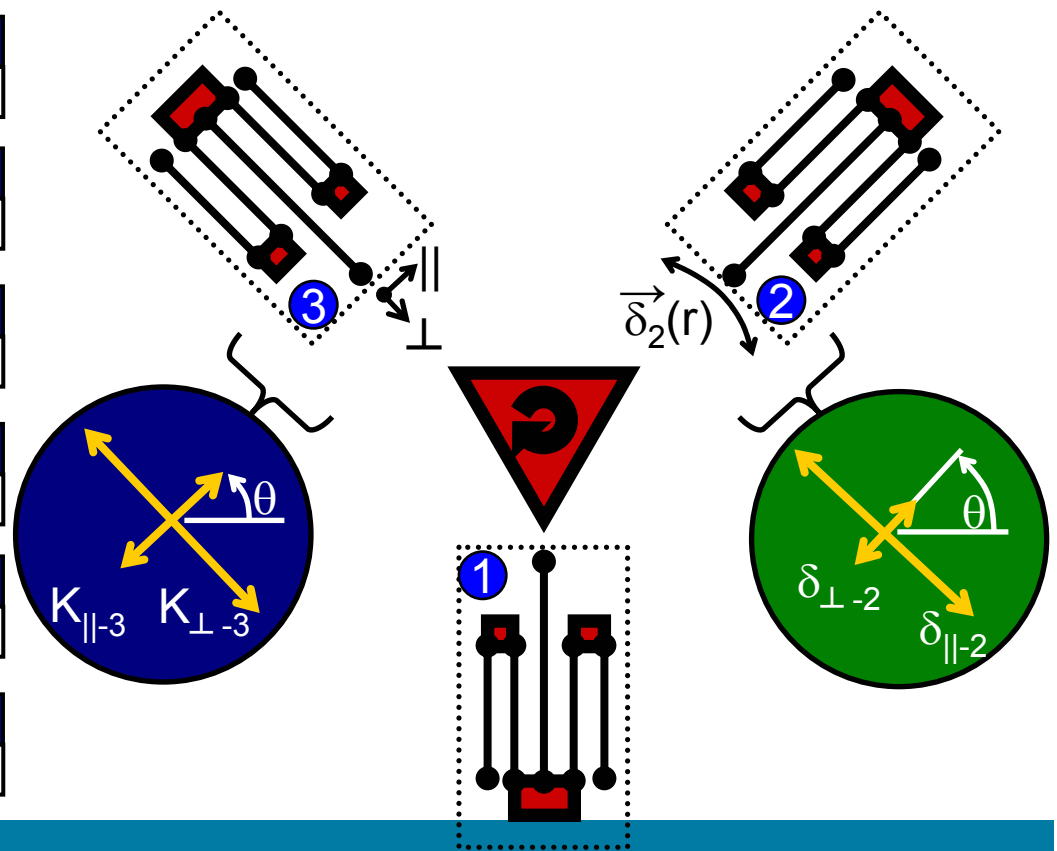

Example: Constraint-based design

Constraint-based compliant mechanism design

STEP 1: Design requirements

Motion path, stiffness, load capacity, etc...

STEP 2: Motion path decomposition

Arcs, lines, rotation pts. sub-paths

STEP 3: Kinematic parametric concepts

Motions, constraint metric, symmetry, etc.

STEP 4: Constraint-motion addition rules

Serial, parallel, hybrid

STEP 5: Topology concept generation

Path & constraint driven

STEP 6: Concept selection phase I

Path errors & over constraint

STEP 7: Size and shape optimization

Stiffness, load capacity, efficiency, etc...

STEP 8: Concept selection phase II

Direct comparison with design requirements

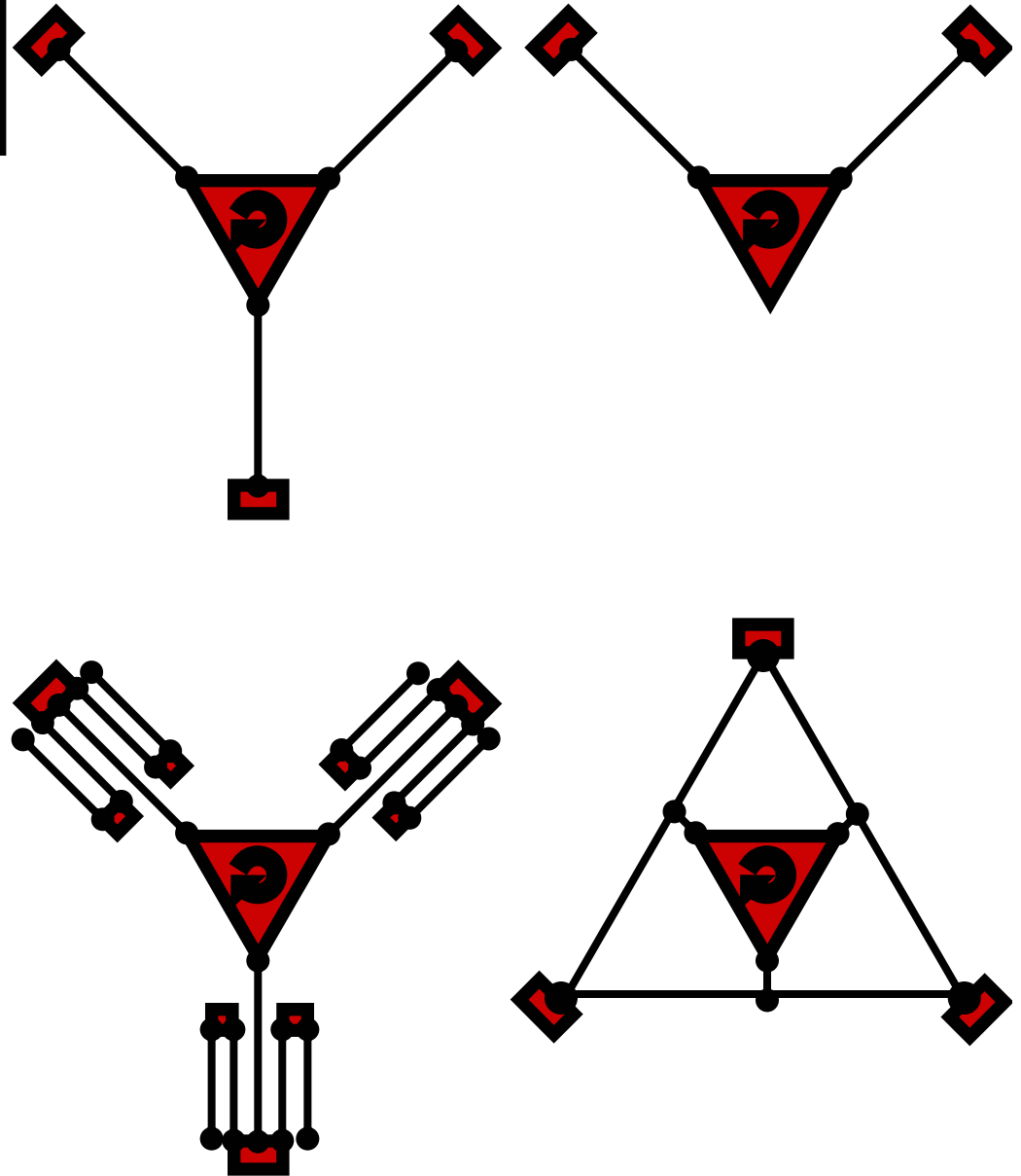

Example: Constraint-based design

Constraint-based compliant mechanism design

STEP 1: Design requirements

Motion path, stiffness, load capacity, etc...

STEP 2: Motion path decomposition

Arcs, lines, rotation pts. sub-paths

STEP 3: Kinematic parametric concepts

Motions, constraint metric, symmetry, etc.

STEP 4: Constraint-motion addition rules

Serial, parallel, hybrid

STEP 5: Topology concept generation

Path & constraint driven

STEP 6: Concept selection phase I

Path errors & over constraint

STEP 7: Size and shape optimization

Stiffness, load capacity, efficiency, etc...

STEP 8: Concept selection phase II

Direct comparison with design requirements

CoMeT: Compliant Mechanism Tool

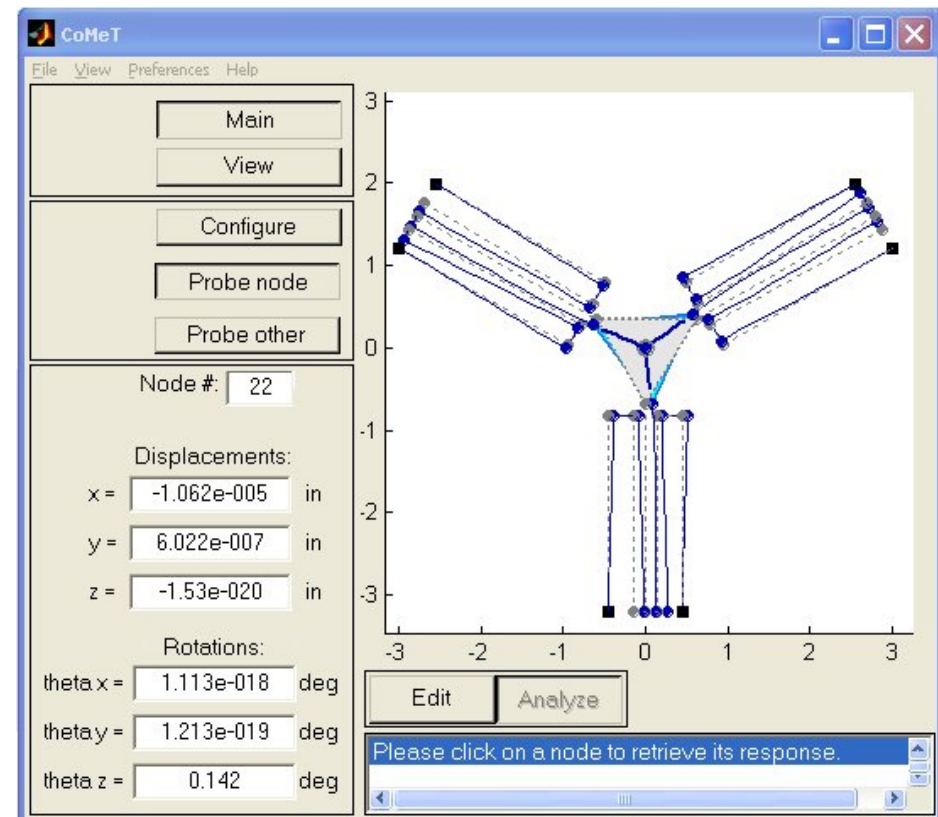

Example: Constraint-based design

Constraint-based compliant mechanism design

STEP 1: Design requirements

Motion path, stiffness, load capacity, etc...

STEP 2: Motion path decomposition

Arcs, lines, rotation pts. sub-paths

STEP 3: Kinematic parametric concepts

Motions, constraint metric, symmetry, etc.

STEP 4: Constraint-motion addition rules

Serial, parallel, hybrid

STEP 5: Topology concept generation

Path & constraint driven

STEP 6: Concept selection phase I

Path errors & over constraint

STEP 7: Size and shape optimization

Stiffness, load capacity, efficiency, etc...

STEP 8: Concept selection phase II

Direct comparison with design requirements

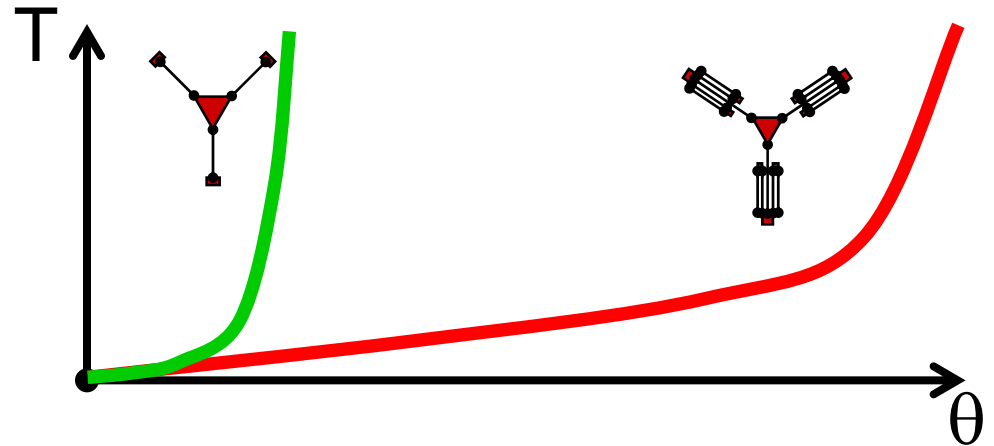

Example: Constraint-based design

Constraint-based compliant mechanism design

STEP 1: Design requirements

Motion path, stiffness, load capacity, etc...

STEP 2: Motion path decomposition

Arcs, lines, rotation pts. sub-paths

STEP 3: Kinematic parametric concepts

Motions, constraint metric, symmetry, etc.

STEP 4: Constraint-motion addition rules

Serial, parallel, hybrid

STEP 5: Topology concept generation

Path & constraint driven

STEP 6: Concept selection phase I

Path errors & over constraint

STEP 7: Size and shape optimization

Stiffness, load capacity, efficiency, etc...

STEP 8: Concept selection phase II

Direct comparison with design requirements

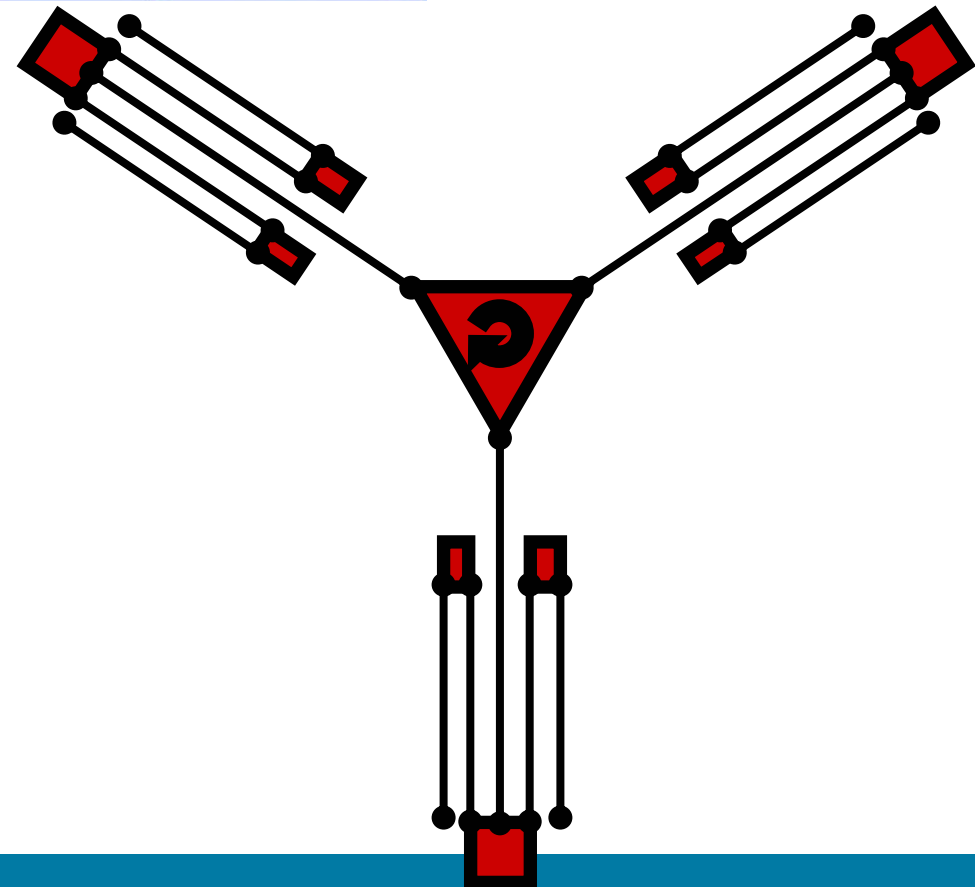
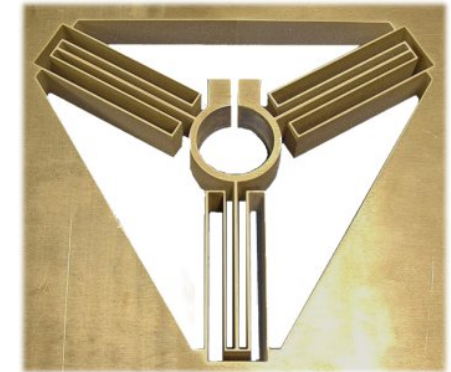
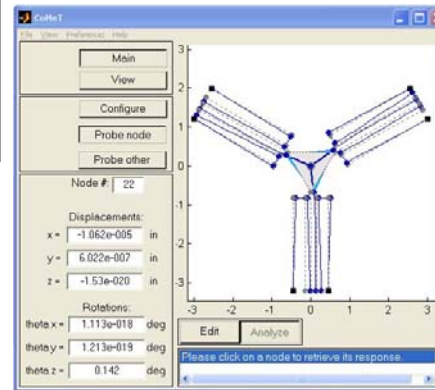

Example: Constraint-based design

Constraint-based compliant mechanism design

STEP 1: Design requirements

Motion path, stiffness, load capacity, etc...

STEP 2: Motion path decomposition

Arcs, lines, rotation pts. sub-paths

STEP 3: Kinematic parametric concepts

Motions, constraint metric, symmetry, etc.

STEP 4: Constraint-motion addition rules

Serial, parallel, hybrid

STEP 5: Topology concept generation

Path & constraint driven

STEP 6: Concept selection phase I

Path errors & over constraint

STEP 7: Size and shape optimization

Stiffness, load capacity, efficiency, etc...

STEP 8: Concept selection phase II

Direct comparison with design requirements

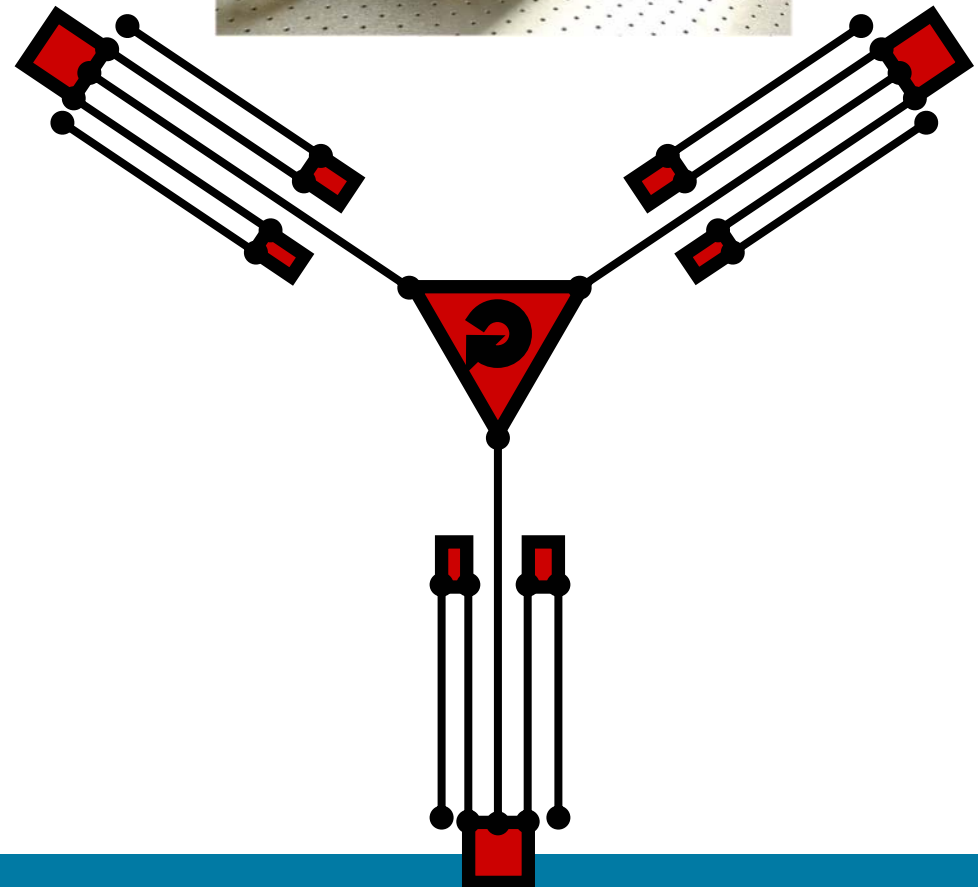
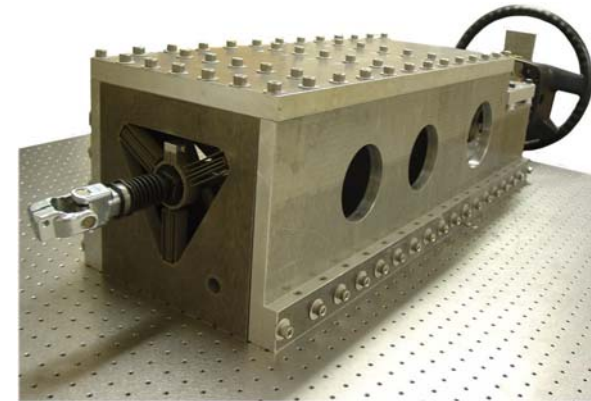

Compliant mechanism tool: CoMeT

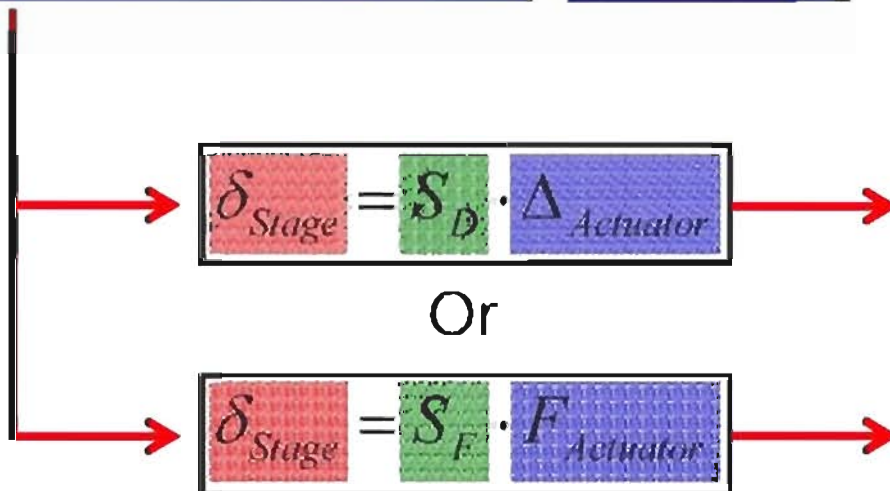
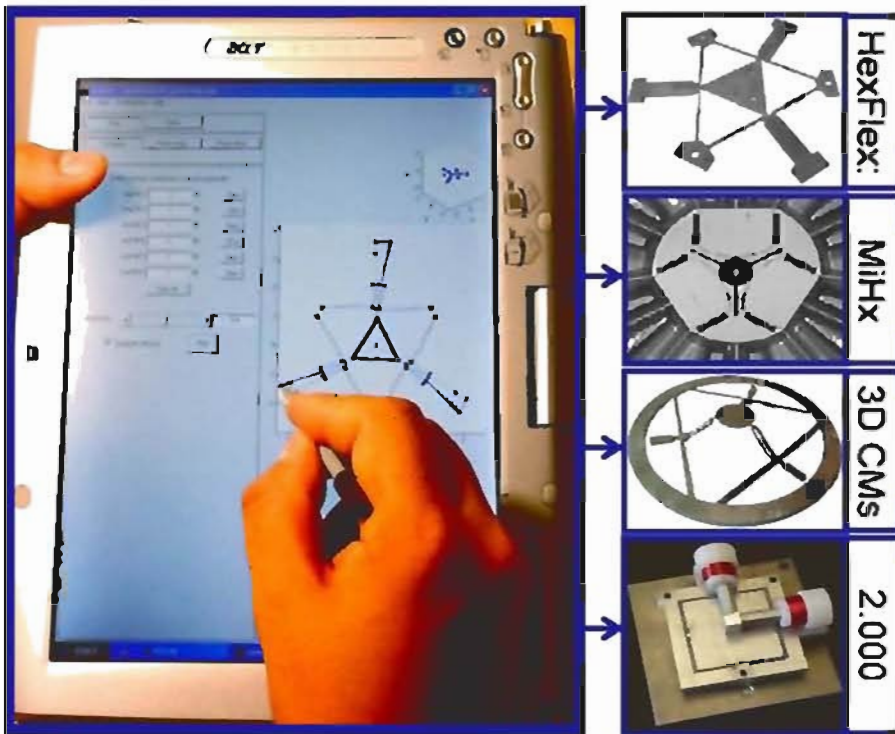

x	N_{x1}	N_{x2}	N_{x3}	0	0	0	Δ_x
y	N_{y1}	N_{y2}	N_{y3}	0	0	0	Δ_y
z	0	0	0	N_{z4}	N_{z5}	N_{z6}	Δ_z
θ_x	0	0	0	$N_{\theta x4}$	$N_{\theta x5}$	$N_{\theta x6}$	$\Delta_{\theta x}$
θ_y	0	0	0	$N_{\theta y4}$	$N_{\theta y5}$	$N_{\theta y6}$	$\Delta_{\theta y}$
θ_z	$N_{\theta z1}$	$N_{\theta z2}$	$N_{\theta z3}$	0	0	0	$\Delta_{\theta z}$

Design activity

Problem

Design a mechanical filter which:

- $G_{ij} = 0.05$ (factor of 20 filtering)
- Range of 0.5 mm with less than 5 micron PE
- Envelope: 5 x 5 x 0.125 inches

Give us enough information to:

- Understand your constraint topology
- Fabricate it
- Assume it is aluminum

Email journal file at end of class

You may ask any question at any time...

Assignment

**Form teams of 4 now, email members to TA
by 5pm Friday**

Flexure reading (pp. 67-82 & 174-205)

CoMeT tutorials 1 - 3

Learn a CAD package (3 wks!!!)

**Create CoMeT model of your flexure, send to
TA by Monday 9am**