

6.003: Signals and Systems

Convolution

March 2, 2010

Mid-term Examination #1

Tomorrow, Wednesday, March 3, 7:30-9:30pm.

No recitations tomorrow.

Coverage: Representations of CT and DT Systems
Lectures 1-7
Recitations 1-8
Homeworks 1-4

Homework 4 will not be collected or graded. Solutions are posted.

Closed book: 1 page of notes (8½ × 11 inches; front and back).

Designed as 1-hour exam; two hours to complete.

Multiple Representations of CT and DT Systems

Verbal descriptions: preserve the rationale.

Difference/differential equations: mathematically compact.

$$y[n] = x[n] + z_0 y[n - 1] \qquad \dot{y}(t) = x(t) + s_0 y(t)$$

Block diagrams: illustrate signal flow paths.



Operator representations: analyze systems as polynomials.

$$\frac{Y}{X} = \frac{1}{1 - z_0 \mathcal{R}} \qquad \frac{Y}{X} = \frac{\mathcal{A}}{1 - s_0 \mathcal{A}}$$

Transforms: representing diff. equations with algebraic equations.

$$H(z) = \frac{z}{z - z_0} \qquad H(s) = \frac{1}{s - s_0}$$

Convolution

Representing a system by a single signal.

Responses to arbitrary signals

Although we have focused on responses to simple signals ($\delta[n], \delta(t)$) we are generally interested in responses to more complicated signals.

How do we compute responses to a more complicated input signals?

No problem for difference equations / block diagrams.
→ use step-by-step analysis.

Check Yourself

Example: Find $y[3]$

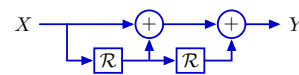

when the input is

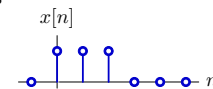

- 1. 1
- 2. 2
- 3. 3
- 4. 4
- 5. 5

0. none of the above

Superposition

Break input into additive parts and sum the responses to the parts.

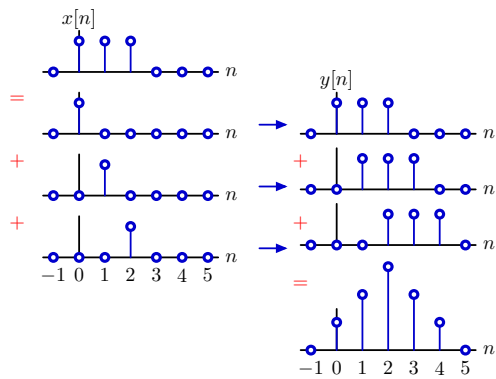

Superposition works if the system is **linear**.

Linearity

A system is linear if its response to a weighted sum of inputs is equal to the weighted sum of its responses to each of the inputs.

Given

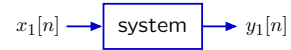

and

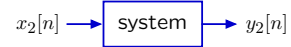

the system is linear if

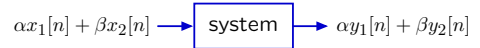

is true for all α and β .

Superposition

Break input into additive parts and sum the responses to the parts.

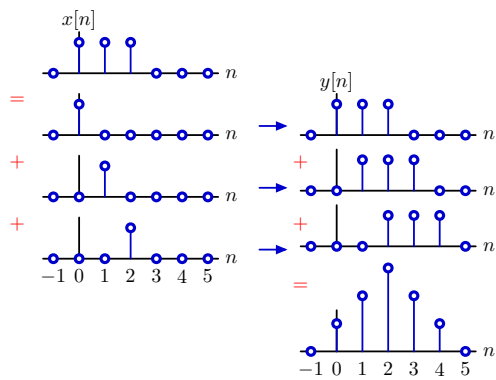

Responses to parts are easy to compute if system is **time-invariant**.

Time-Invariance

A system is time-invariant if delaying the input to the system simply delays the output by the same amount of time.

Given

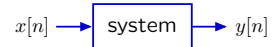

the system is time invariant if

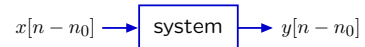

is true for all n_0 .

Superposition

Break input into additive parts and sum the responses to the parts.

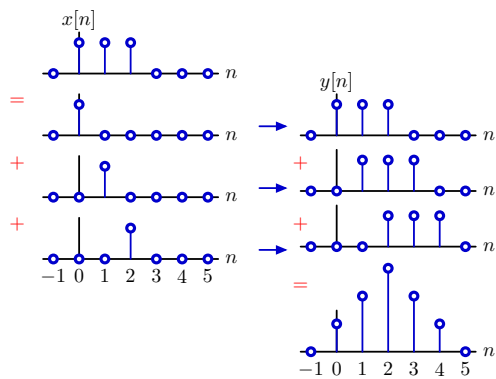

Superposition is easy if the system is **linear** and **time-invariant**.

Structure of Superposition

If a system is linear and time-invariant (LTI) then its output is the sum of weighted and shifted unit-sample responses.

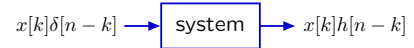
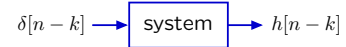
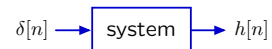

$$x[n] = \sum_{k=-\infty}^{\infty} x[k]\delta[n - k] \rightarrow \text{system} \rightarrow y[n] = \sum_{k=-\infty}^{\infty} x[k]h[n - k]$$

Convolution

Response of an LTI system to an arbitrary input.

$$x[n] \rightarrow \text{LTI} \rightarrow y[n]$$

$$y[n] = \sum_{k=-\infty}^{\infty} x[k]h[n-k] \equiv (x * h)[n]$$

This operation is called **convolution**.

Notation

Convolution is represented with an asterisk.

$$\sum_{k=-\infty}^{\infty} x[k]h[n-k] \equiv (x * h)[n]$$

It is customary (but confusing) to abbreviate this notation:

$$(x * h)[n] = x[n] * h[n]$$

Notation

Do not be fooled by the confusing notation.

Confusing (but conventional) notation:

$$\sum_{k=-\infty}^{\infty} x[k]h[n-k] = x[n] * h[n]$$

$x[n] * h[n]$ looks like an operation of samples; but it is not!

$$x[1] * h[1] \neq (x * h)[1]$$

Convolution operates on signals not samples.

Unambiguous notation:

$$\sum_{k=-\infty}^{\infty} x[k]h[n-k] \equiv (x * h)[n]$$

The symbols x and h represent DT signals.

Convoluting x with h generates a new DT signal $x * h$.

Structure of Convolution

$$y[2] = \sum_{k=-\infty}^{\infty} x[k]h[2-k]$$

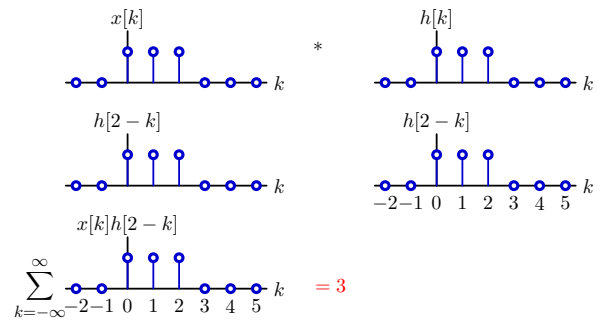

Structure of Convolution

$$y[3] = \sum_{k=-\infty}^{\infty} x[k]h[3-k]$$

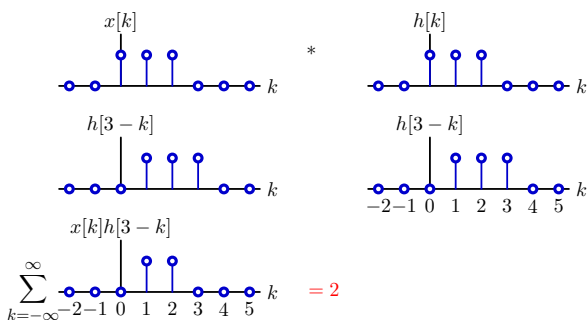

Check Yourself

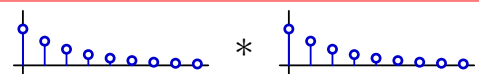

Which plot shows the result of the convolution above?

- 1.
- 2.
- 3.
- 4.

5. none of the above

Convolution

Representing an LTI system by a single signal.

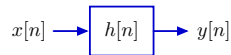

Unit-sample response $h[n]$ is a complete description of an LTI system.

Given $h[n]$ one can compute the response $y[n]$ to any arbitrary input signal $x[n]$:

$$y[n] = (x * h)[n] \equiv \sum_{k=-\infty}^{\infty} x[k]h[n-k]$$

CT Convolution

The same sort of reasoning applies to CT signals.

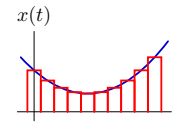

$$x(t) = \lim_{\Delta \rightarrow 0} \sum_k x(k\Delta)p(t-k\Delta)\Delta$$

where

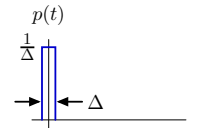

As $\Delta \rightarrow 0$, $k\Delta \rightarrow \tau$, $\Delta \rightarrow d\tau$, and $p(t) \rightarrow \delta(t)$:

$$x(t) \rightarrow \int_{-\infty}^{\infty} x(\tau)\delta(t-\tau)d\tau$$

Structure of Superposition

If a system is linear and time-invariant (LTI) then its output is the integral of weighted and shifted unit-impulse responses.

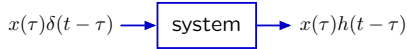
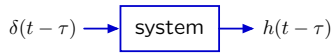
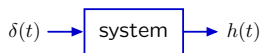

$$x(t) = \int_{-\infty}^{\infty} x(\tau)\delta(t-\tau)d\tau \rightarrow \text{system} \rightarrow y(t) = \int_{-\infty}^{\infty} x(\tau)h(t-\tau)d\tau$$

CT Convolution

Convolution of CT signals is analogous to convolution of DT signals.

$$\text{DT: } y[n] = (x * h)[n] = \sum_{k=-\infty}^{\infty} x[k]h[n-k]$$

$$\text{CT: } y(t) = (x * h)(t) = \int_{-\infty}^{\infty} x(\tau)h(t-\tau)d\tau$$

Check Yourself

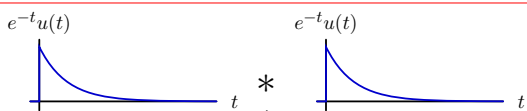

Which plot shows the result of the convolution above?

- 1.
- 2.
- 3.
- 4.

5. none of the above

Convolution

Convolution is an important **computational tool**.

Example: characterizing LTI systems

- Determine the unit-sample response $h[n]$.
- Calculate the output for an arbitrary input using convolution:

$$y[n] = (x * h)[n] = \sum x[k]h[n-k]$$

Applications of Convolution

Convolution is an important **conceptual tool**: it provides an important new way to **think** about the behaviors of systems.

Example systems: microscopes and telescopes.

Microscope

Images from even the best microscopes are blurred.

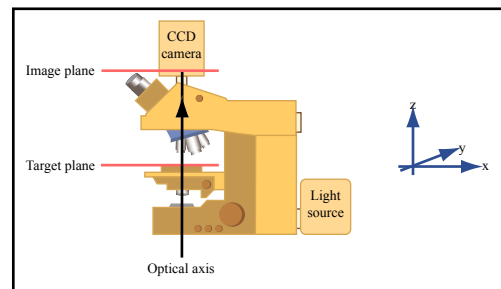
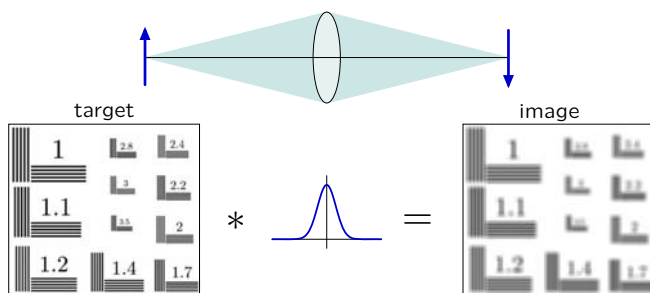

Figure by MIT OpenCourseWare.

Microscope

Blurring can be represented by convolving the image with the optical "point-spread-function" (3D impulse response).



Blurring is inversely related to the diameter of the lens.

Microscope

Measuring the "impulse response" of a microscope.

Image diameter ≈ 6 times target diameter: target \rightarrow impulse.

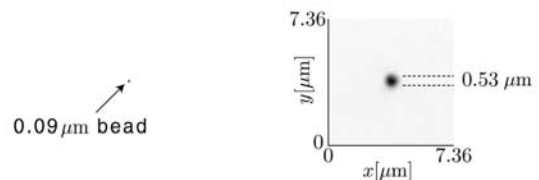

image of a 0.09 μm bead

images by Anthony Patire

Courtesy of Anthony Patire. Used with permission.

Microscope

Images at different focal planes can be assembled to form a three-dimensional impulse response (point-spread function).

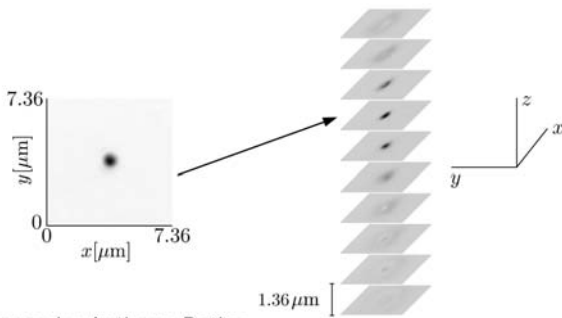

images by Anthony Patire

Courtesy of Anthony Patire. Used with permission.

Microscope

Blurring along the optical axis is better visualized by resampling the three-dimensional impulse response.

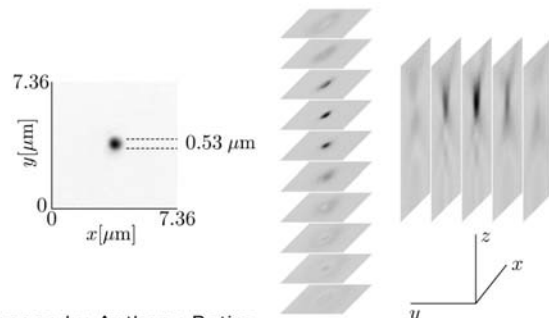

images by Anthony Patire

Courtesy of Anthony Patire. Used with permission.

Microscope

Blurring is much greater along the optical axis than it is across the optical axis.

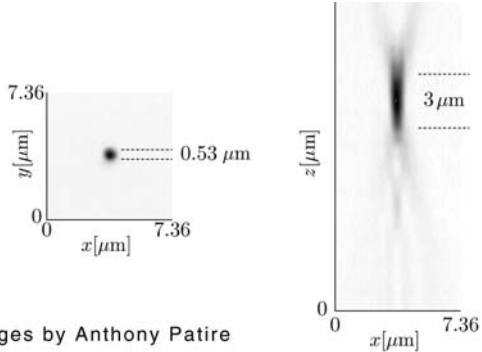

images by Anthony Patire

Courtesy of Anthony Patire. Used with permission.

Microscope

The point-spread function (3D impulse response) is a useful way to characterize a microscope. It provides a direct measure of blurring, which is an important figure of merit for optics.

Hubble Space Telescope

Hubble Space Telescope (1990-)



<http://hubblesite.org>

Hubble Space Telescope

Why build a space telescope?

Telescope images are blurred by the telescope lenses AND by atmospheric turbulence.

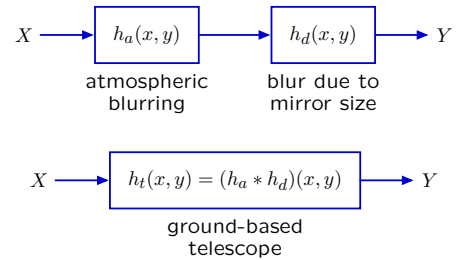

Hubble Space Telescope

Telescope blur can be represented by the convolution of blur due to atmospheric turbulence and blur due to mirror size.

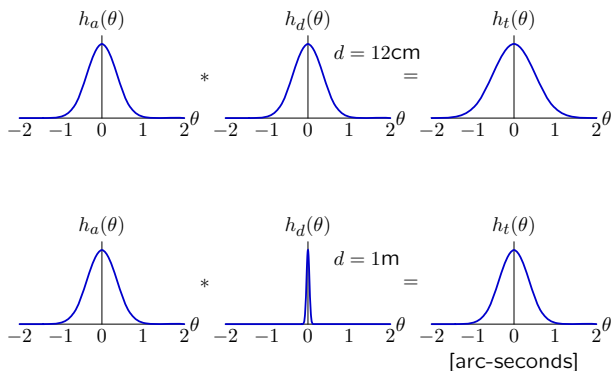

Hubble Space Telescope

The main optical components of the Hubble Space Telescope are two mirrors.

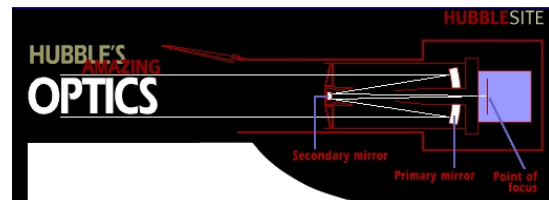

<http://hubblesite.org>

Hubble Space Telescope

The diameter of the primary mirror is 2.4 meters.



<http://hubblesite.org>

Hubble Space Telescope

Hubble's first pictures of distant stars (May 20, 1990) were more blurred than expected.

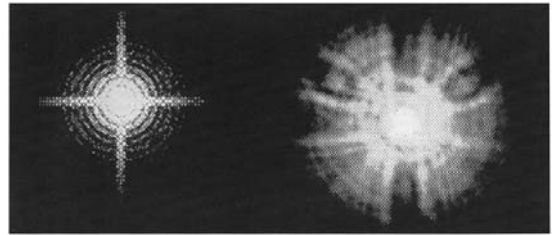

expected
point-spread
function

early Hubble
image of
distant star

<http://hubblesite.org>

Hubble Space Telescope

The parabolic mirror was ground $4 \mu\text{m}$ too flat!



<http://hubblesite.org>

Hubble Space Telescope

Corrective Optics Space Telescope Axial Replacement (COSTAR):
eyeglasses for Hubble!

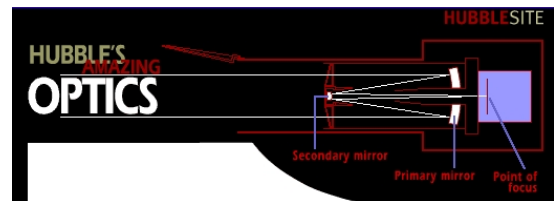

Hubble Space Telescope

Hubble images before and after COSTAR.

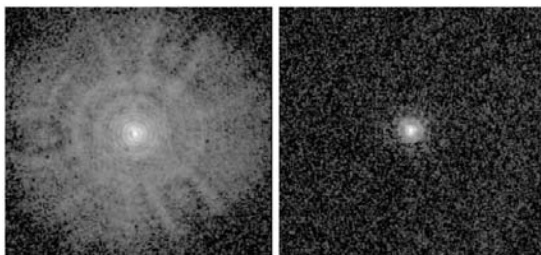

before

after

<http://hubblesite.org>

Hubble Space Telescope

Hubble images before and after COSTAR.



before

after

<http://hubblesite.org>

Hubble Space Telescope

Images from ground-based telescope and Hubble.

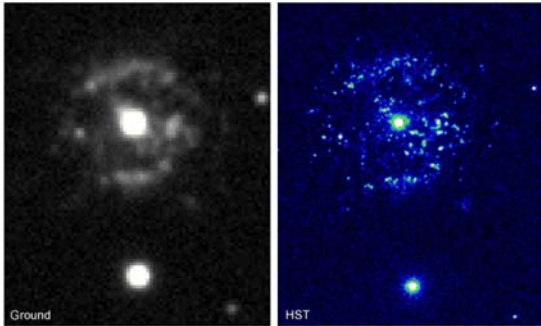

<http://hubblesite.org>

Impulse Response: Summary

The impulse response is a complete description of a linear, time-invariant system.

One can find the output of such a system by convolving the input signal with the impulse response.

The impulse response is an especially useful description of some types of systems, e.g., optical systems, where blurring is an important figure of merit.

MIT OpenCourseWare
<http://ocw.mit.edu>

6.003 Signals and Systems
Spring 2010

For information about citing these materials or our Terms of Use, visit: <http://ocw.mit.edu/terms>.